

“The Headliner”

Newsletter of the Northern Ohio Regional Group #20
Early Ford V-8 Club of America
Our 54th Year



Volume 30 Number 11

November 2023

Mission Statement: “To preserve and authentically maintain vehicles manufactured by the Ford Motor Company for the model years 1932 through 1953 inclusive, and to serve as an accurate and technical source of information concerning these automobiles for the benefit of its members as well as the general public.”

Presidents Message

I am sorry to say I think the summer if it isn't gone already the nasty weather is soon to come. As much as I don't want to do it, I think it is time to put the cars away for a long winter nap, pack them up tight, pat them on the nose and say good night. Our next meeting is Nov.17. Please try to make this meeting as it is a very important one.

1st on the agenda is nomination for 2024 board members. If anyone has the desire to toss their hat in the ring do not hesitate. By joining the board of directors, it does not take much of your time. It is a good way to voice and act on your ideas. Also, you get a first-hand view of the inner workings of our club. As I have said many times before. This is all of our organization and only as good as the participation of us the members. Along with the nominations we will also vote on a slate of new officers for the year 2024.

2nd we will be passing around a signup sheet for volunteers to take over the coffee and treats for a monthly meeting. Coffee and sweets is a nice way to break up a meeting, but we need a member a month to take over this task. I hope that this year the volunteers will step forward sooner than last year so we can continue this monthly tradition.

3rd Our Dec. meeting is Dec. 15, 2023. What is the members thought on holding a meeting .10 days before Christmas?

Lastly, we will be holding our annual **INSALATION BANQUET ON SUN. January 21, 2024. Information is in this newsletter. The cost will be in the \$30.00 range and final details will be sent out the first week of Dec. DUE TO PROBLEMS LAST YEAR THERE WILL BE NO PAY AT THE DOOR. Reservations and money must be in by JAN.14, 2024. (NO EXCEPTIONS.)** If anyone has any questions please give me a call or bring them up during the Nov. meeting.

With this said Sharon and I would like to wish you yours and a Happy Thanksgiving. Enjoy your family and friends! Remember don't eat too much turkey and drive, as turkey tends to put one to sleep. ENJOY,

Jack



Our November Program will be speaker be Justin Hamling, who will discuss the ins and outs of estate planning.



Officers & Board 2023

President: Jack Bukszar
Vice President: Frank Posar
Secretary: Neal Garland
Treasurer: Dan & Diane Francis

Directors

Rick Jandrey
Steve Kronen
Ron Mihalek
Beth Schilling

**All Meetings are held at
Stow Community Center
3800 Graham Road
Stow, OH**

“Kick Tires”: 7:00
Meeting Begins: 7:30
Ends: 10:00 or Sooner

Website:

www.norgv8club.org

Editors

Annette & Craig Gorris
10160 Echo Hill Drive
Brecksville OH 44141
440-526-6138
annette.gorris@gmail.com



MINUTES FOR THE MEETING OF OCTOBER , 2023

President Jack Bukszar and vice president Frank Posar were unable to attend tonight's meeting, so the meeting was conducted by Secretary Neal Garland. The meeting was called to order at 7:30 p.m. Members were asked to introduce themselves and their cars and to say a few words regarding what they like most about their car and what they like least about it. A wide range of reasons were cited regarding what was liked about the vehicles. The most frequently mentioned thing that was disliked was the vacuum windshield wipers.

Bill and Bonnie Sykes were thanked for providing coffee and cookies for this evening. We appreciate their time and effort!

Rick Jandrey introduced our speaker for this evening, Jeff Greenberg. Jeff is a representative of Certified Auto Electric, which is located in Bedford, Ohio. Jeff explained that they specialize in rebuilding electrical components such as generators and alternators, including those for antique cars. They also can track down electrical problems in cars and will do complete re-wiring if it is necessary. If any part of your car's electrical system needs attention, Jeff can be reached at 440-439-1100.

Thanks were given to Ron and Karen Mihalek for hosting the corn roast on September 23 and to Craig Gorris and Bruce Lewicki for their excellent work as chefs. The corn, brats, and hot dogs were all delicious!

Committee reports were given. Treasurers Dan and Diane Francis stated that our treasury remains in good shape, which means there is still money in it. Webmaster Regis Schilling informed us that our website is also in good shape and has no immediate problems.

Membership chair Craig Gorris told us that we have 85 members in our roster. He reminded us that dues for 2024 are due. Please be sure to fill out the membership form that is in the Newsletter and mail it and your check to him as soon as possible if you have not done so already.

Newsletter editors Craig and Annette Gorris reported that things are going well with the Headliner. Be sure to send items to them that you feel might be of interest for inclusion in the Newsletter.

National Representative Steve Kronen reported on activities of the national board of directors. He reminded us that he will not seek re-election to the National Board for next year and he encouraged any members who are interested in a position on the board to let him know so he can submit the names to the national office.

Six members enjoyed the October lunch at Cooper's Hawk restaurant. The November lunch will be at Das Schnitzel Haus in Parma on Thursday, November 9. If you enjoy German food be sure to put this on your calendar

Members were reminded that our combination Christmas Party/installation banquet is tentatively scheduled for January 15 at D'Agnese's Restaurant in Akron. Also, we will be voting on officers and members of the board of directors for 2024 at the November meeting. If you are interested in serving in one of these positions please call Neal at 330-338-1510 so your name can be put on the ballot.

Rick Jandrey reminded us of the Marshallville car show that will be held tomorrow (Oct. 21), and he informed us that the speaker for next month will be Justin Hamling, who will speak about estate planning.

Rick Jandrey moved that we adjourn. We adjourned at 8:45 p.m.

Neal Garland, Secretary

**Very Important Message
From National Vice President Steve Kronen**

Members of Northern Ohio Regional Group. This year is my third year on the Board of Directors and I serve as the Vice President for the year of 2023. This year is also my final year on the Board as I have decided to not run for a second term at this time.

I've enjoyed my time on the Board, serving to keep this great club running.

Any NORG member interested in serving on the National Board please contact me and I will send it to President Rick Claybaugh for consideration.

Steve

Message from NORG Newsletter Co-Editor Craig Gorris

NORG members, This is an opportunity to become active in the National Club. I served on the National Board from 2003 ~ 2008 and was National President from 2006~2008. NORG has had three members serve on the National board. Beside myself, Dave Collette and Steve have served.

In my opinion, it is a great way to support the national organization, meet members from all over the world and have the satisfaction that you "will have made a difference". If any member is interested, please contact Steve or myself and we will answer

NO DECEMBER NEWSLETTER

Our next Newsletter will be published at the end of December. We will combine the December and January Newsletter into one. Beginning in February we will publish a Newsletter each month

NORG COOKIE VOLUNTEERS NEEDED FOR 2024

Members, each year, we ask and so many of you volunteer to supply baked goods for our monthly meetings. We will be passing a sheet at our next meeting asking for volunteers to sign up for a monthly meeting. Please consider helping us out with coffee and cookies



NORG COOKIE BAKERS 2023



November	Diane Francis
----------	---------------

2023– 24 Activities At A Glance



- **Thursday, November 9th** NORG Luncheon, Das Schnitzel House Restaurant
- **Friday, November 17th** NORG Meeting Stow City Center 7:30
- **Friday, December 8th** NORG Luncheon, **Olesia's Restaurant, more info on this page**
- **Friday, December 8th** St. Basil Christmas Concert. **See Page 8 for details**
- **Sunday January 21st 2024** NORG Installation Banquet **See page 9 for information**
- **Thursday, February 8th 2024** NORG Luncheon Casa D'Angelo's 893 Aurora Road Macedonia, Ohio 44056
- **Friday, February 16th** NORG Meeting Stow City Center 7:30

December Luncheon Olesia's Taverne of Richfield Friday, December 8th



A historic structure and a wonderful place to eat with a very comprehensive menu . Something for everyone

They are located at 3960 Broadview Road near corner of Broadview Road (RT 176)and RT 303 in Richfield Phone: (234) 400-0288

If you are planning on coming, please call Neal Garland at 330-338-1510 so he can reserve space

2024 Membership Dues are Due

Northern Ohio Regional Group Members your 2023 dues are due. Dues are still only \$30.00 which includes a Newsletter throughout the year as well as a 2023 Roster of members.

See page 5 for a membership form

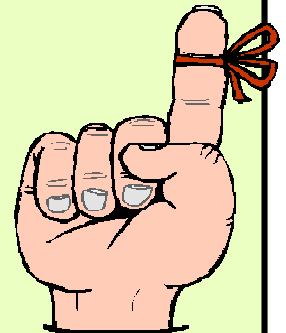

Northern Ohio Regional Group 20
Early Ford V8 Club of America
Membership Form
Annual Month Dues \$30.00

Year
2024

Date: _____ National Number: _____

Name _____ Spouse _____

Address _____

City, State, Zip _____

Phone Number _____ Cell Phone Number _____

E Mail Address _____ We send Newsletters by E Mail unless there is an exception

Fax _____

BIRTHDAY, MONTH & DAY: Self _____ Spouse _____

Winter Address _____ From _____ To _____

City, State, Zip _____

Phone Number _____

List all Early Fords you own from 1932 to 1953 and Highest Award won at a National Meet:

YEAR	MAKE	MODEL	AWARD



Make Check Payable to: N.O.R.G.
MAIL TO:
Craig Gorris
10160 Echo Hill Dr.
Brecksville, OH 44141



The Memoirs of the 1942 Mercury Convertible VIN 99A-501168

In late 1941, I began life at the end of the Mercury assembly line. The year 1942 was to be a banner year for Mercury cars. Unfortunately, the attack on Pearl Harbor changed not only the history of the United States but also the future of the 1942 Mercury. Ford Motor Company completed only 956 convertibles before retooling for military vehicles, tanks, and airplanes in support of the United States war effort.



My original owner was limited in driving me because of gasoline rationing, the shortage of rubber for tires, and a number of other restrictions. Consequently, I traveled only a few thousand miles in the first five years of my life. The sixth year however, brought on significant changes. My second owner, a career Navy man, had just returned from the Far East after the surrender of Japan and had been stationed in Dallas, Texas. Finding a reliable car for himself during this period was extremely difficult. The automobile manufacturers were just beginning to fill the pent up civilian demand resulting from the past 3 years when there was no new car production. After my new owner bought me, my life was full of new adventures. He took very good care of me and I took him wherever the Navy sent him.

The Mercury at 2003 Eastern National Meet, Fredrick, MD.

From Dallas, I was driven to Norfolk, Virginia and put aboard a ship bound for Guantanamo Bay, Cuba. During the next two years, I faithfully took him at the 25 mph base speed limit to his regular duties and on fishing trips. After Cuba, I was once again placed on board a ship and, in due time, reunited with my owner in New York City. We then took a long journey to San Diego, California, stopping en-route at many historical sites including Mount Rushmore, the Grand Canyon, Yellowstone National Park, Bryce Canyon, and other interesting historical places. While I rested at each of the many places, he and his wife went sightseeing. Once settled in San Diego, we made trips to Mexico and many cities and towns throughout California.

After a short time, I was again prepared for another long trip across the continent to Virginia Beach, Virginia where my owner was stationed at the Amphibious Base. In Virginia, I was put on another ship and the next time I saw my owner was in Bremerhaven, Germany. There I was offloaded and he drove me to Vienna, Austria through deep snow and ice storms but we made it safely as he expected me to. Here my owner carried out his duties at the Office of the Naval Attaché. This was an interesting place because it was 112 miles behind the Iron Curtain. During this time, I took my owner too many different places in pursuit of his responsibilities

While traveling in Europe, I visited Germany, Austria, Italy, Yugoslavia, France, Spain, Portugal, Andorra, Trieste, Monaco, Liechtenstein, Switzerland, Belgium, Luxembourg, Norway, Denmark, Sweden, and Greece.

In 1955, I was placed on a ship in Leghorn, Italy and the next time I saw my owner was in New York. We traveled to Virginia Beach, Virginia where once again I was home in my own garage. From here we visited all the New England States as well as Canada. Our next journey was



to Jacksonville, Florida where my owner had been stationed. Upon his retirement, my owner taught history and I was utilized on a daily basis. While in Jacksonville, I had the opportunity to appear in the movie, "The New Adventures of Pippi Longstocking". Also, while attending a car show in Daytona Beach, I had the unique opportunity to take a turn around the track at the Daytona International Speedway.



After 50 years with my owner, we understood each other through the process of animism in which he could communicate with me. We had traveled 350,000 miles together and since my owner was getting old, he felt that I should get a complete restoration for historical reasons so that future generations could experience a rare, dependable automobile from the "Good Old Days." An advertisement placed in the V-8 Times Magazine brought a response from Peter Prescott of Manchester, Maine.

Incidentally, my owner had my original 1942 Mercury engine rebuilt and had a spare 59A-B engine which he rotated with the original 29A from time to time. My original 29A was in me and my trunk and insides contained a collection of NOS and used parts when Peter had me transported to Maine. I think I noted a tear in my owner's eye as he drove me into the car hauler for the trip to Maine. Peter has done an outstanding job of restoring me and I am, without a doubt, the most beautiful 1942 in the whole world. My exterior is painted Phoebe Grey, my top is tan, and I have a gorgeous Blue leather interior. After the completion of my restoration, my new owner Peter flew my previous owner and his wife to Maine to put the first mile on the odometer. I felt the same excitement as he drove me around, and I responded to his touch just as I previously had for the 50 years he owned me. These past three years I am enjoying a well deserved retirement. I no longer work and I reside in a comfortable heated garage. When I travel to car shows, I no longer have to go under my own power but am trailered. I enjoy this luxurious new life. I do miss my other owner and hope that he will come to visit me again.

Flathead V-8 Oil Pressure Sending Unit Removal Tool

The removal of a Oil Pressure sending unit from the rear of the flathead V-8 engine when the engine is in the car can be a frustrating task. Seems that no matter how you attack the problem, that the open end wrench or crows foot wrench just will not do the job. I copied the design of a tool that was discussed on the "Ford Barn" some time ago. It can be fabricated from $\frac{1}{8}$ " steel stock.

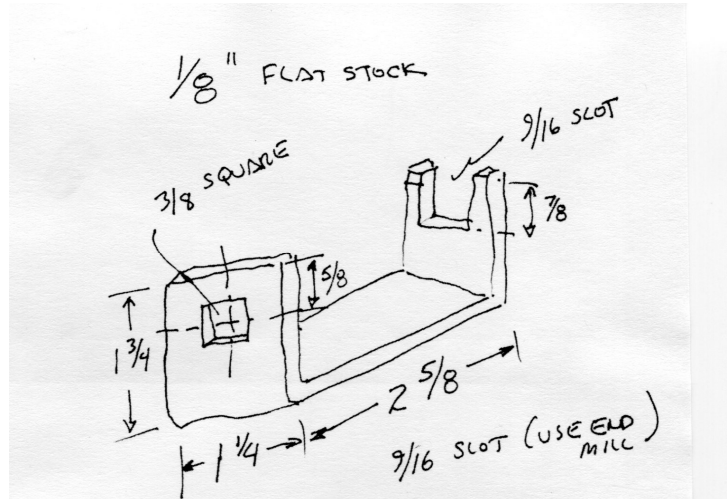
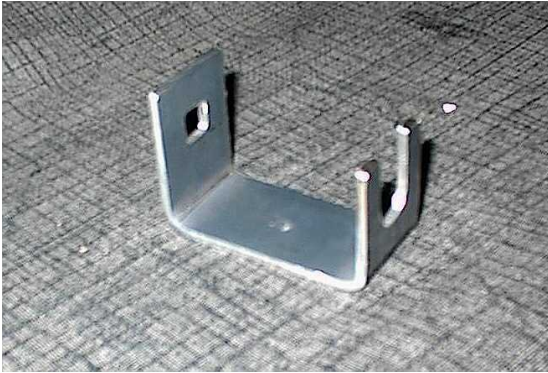

**St Basil The Parish
Christmas Concert
Friday, December 7, 7:00 PM
Brecksville, Ohio**

This is a wonderful way to begin the Christmas season. The concert features an orchestra and over 50 parishioners voices singing a number of traditional as well as new Christmas songs. If you are interested, please call Annette Gorris at 216-215-7255. The church fills up very quickly that evening. Perhaps we could meet earlier for a meal and then attend the concert.

Please call Annette to get an idea of how many people would be interested in going

1936 Ford Deluxe Fordor Humpback Sedan For Sale



Washington Blue with metallic in it. Great Condition. Fresh rebuild on the 59AB motor with 800 miles on it. \$26,000 neg, Loren, 720-289-2019, Denver, CO lrenhelfenbein@gmail.com for more details.

Save The Date

NORG Installation Banquet



SUNDAY JANUARY 21,2024 AT 2:00

**D'AGNESE'S AT WHITE POND
566 WHITE POND RD.
AKRON, OHIO 44320**

DETAILS IN THE December/January Newsletter

Please Patronize Our Advertisers

Busy Bee
 301 S. Court St - Medina, Ohio
 Complete Exhaust Repair... & So Much More

Family Owned and Operated Since 1983 *Come and See Craig or George!*

Brakes
 Shocks
 Suspension
 Engine
 Diagnostics

Craig/George
330-725-2727



Gas Tanks
 Radiators
 Tune Ups
 Emission Repair
 Batteries

website:
bzbmuffler.com

It won't take long...Did it?



CHIEFTAIN
Trucking & Excavating
 FBE / DBE Certified

3926 Valley Road, Ste. 300
 Cleveland, Ohio 44109
 Office (216) 485-8034
 Cell (216) 906-9002

KEN MARTIN
 kmartin@chieftaintrucking.com



NORTH GATEWAY TIRE CO. INC.
 PASSENGER-INDUSTRIAL-FARM-TRUCK TIRE SERVICES

ALIGNMENT - STRUTS
 SUSPENSION WORK
 BRAKES - SHOCKS
 EXHAUST SYSTEMS
 AIR CONDITIONING SERVICE

JEFF HILL
 VICE PRESIDENT RETAIL





4001 PEARL ROAD
 MEDINA, OHIO 44256
 330.725.TIRE (8473)

CLEVE 330.225.8001
 FAX 330.725.8550
 EMAIL jhill@dktire.com

CERTIFIED AUTO ELECTRIC, INC.
 225 Northfield Road • Bedford, Ohio 44146

Chrome Units for Show Cars
 Special Handling for Classic & Antiques
 Interstate Battery Dealer

EARL OR JEFF
 (440) 439-1100
 (888) 597-8278
 (START)
 www.certifiedautoelectric.com

Mon-Fri 8 a.m. to 5 p.m.
 Sat 9 a.m. to Noon



TONY'S
 AUTO WORLD

Sales • Service • Parts
 ALL MAKES AND MODELS

A NAME YOU CAN TRUST

Tony DiFiore Owner
 tony@tonysautoworld.com

phone 216-433-1800
 fax 216-433-4731

5905 West 130th St.
 Parma, Ohio 44130
 www.tonysautoworld.com

*Don't Forget to Check out our updated website :
www.norgv8club.org*

The Headliner Deadline
 1st Day of each month. Please e-mail articles, tech tips, outings, adds, club news and pictures to:
Annette Gorris
annette.gorris@gmail.com

November Birthdays

4	Ed Harants
6	Annette Gorris
11	Jay Rounds
24	Gene Sanders



November Meeting
Friday November 17th
7:30
Stow City Center