

PART NUMBER	PART NAME	NO. REQ'D	PART NUMBER	PART NAME	NO. REQ'D
-------------	-----------	-----------	-------------	-----------	-----------

Rear Bumper

1934

CONVERTIBLE SEDAN

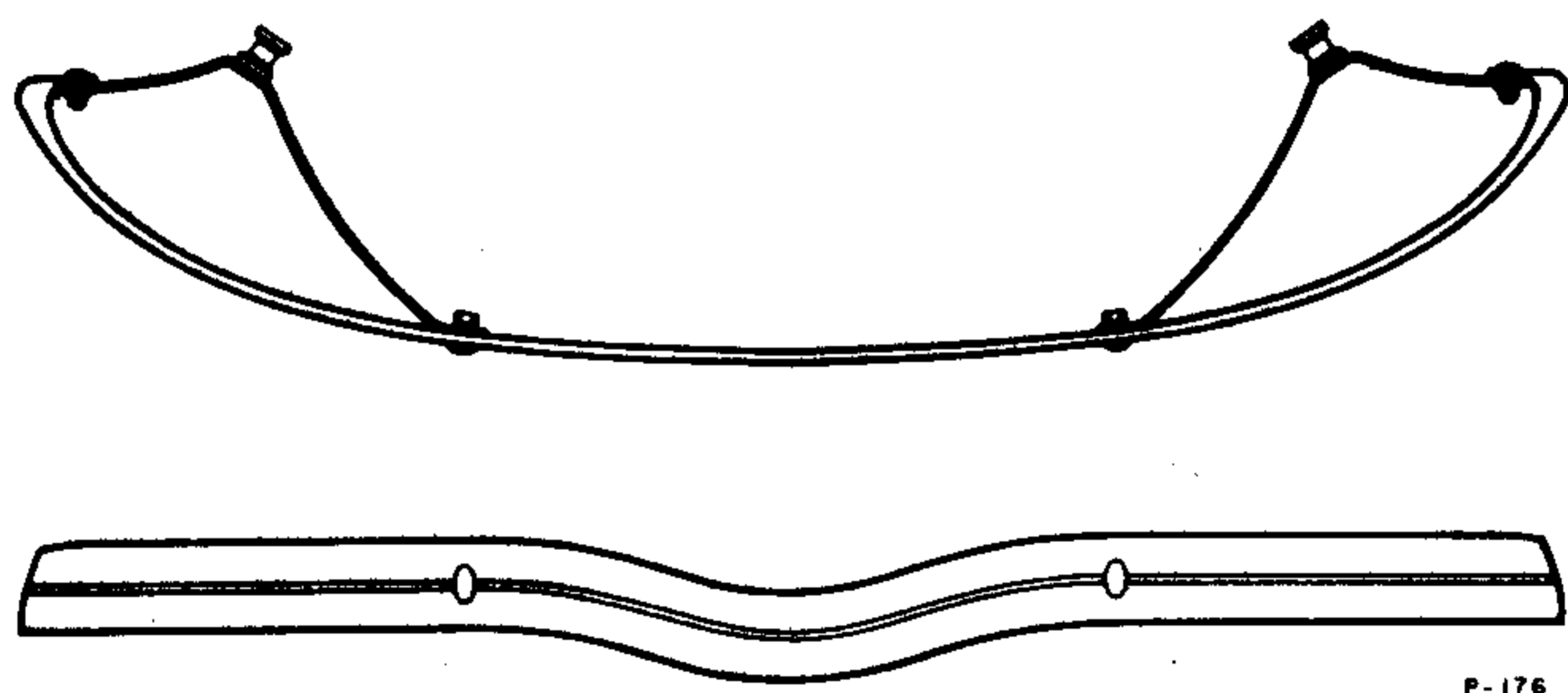

P-176

+40 17906-B	Bar	1
+40 17787-D	Arm	2
+40 17790	Spacer	2
23428-S2	Bolt (arm to bar)-outer	2
33802-S8	Nut (arm to bar bolt)-outer	2
34808-S8	Lockwasher (arm to bar bolt)-outer	2
11A 17758	Bolt (arm to bar)-inner-without guards	2
23550-S2	Bolt (arm to bar)-inner-with guards	2
33846-S8	Nut (arm to bar bolt)	2
34809-S8	Lockwasher (arm to bar bolt)	2

1934

PANEL DELIVERY

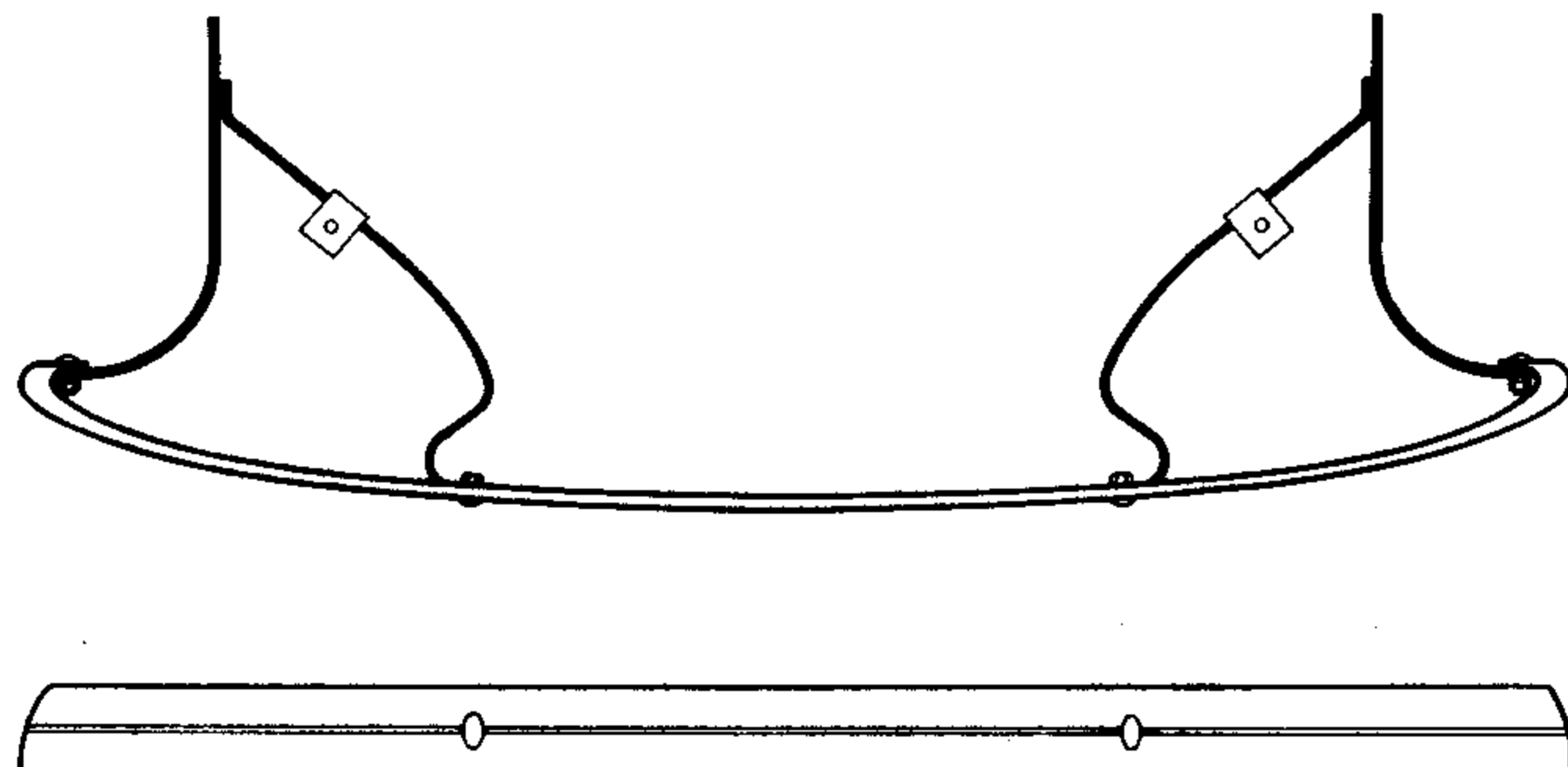

P-190

+68 17757	Bar	1
+46 17795-B	Arm (outer)-RH	1
+46 17796-B	Arm (outer)-LH	1
+46 17766-B	Arm (inner)	2
+46 17959-B	Support arm (inner)	2
23428-S2	Bolt (outer arm to bar)	2
33802-S8	Nut (outer arm to bar bolt)	2
34808-S8	Lockwasher (outer arm to bar bolt)	2
11A 17758	Bolt (inner arm to bar)-w/o guards	2
23550-S2	Bolt (inner arm to bar)-with guards	2
33846-S8	Nut (inner arm to bar bolt)	2
34809-S8	Lockwasher (inner arm to bar bolt)	2
24453-S8	Bolt (inner to outer arm)	2
33846-S8	Nut (inner to outer arm bolt)	2
34809-S8	Lockwasher (inner to outer arm)	2
24453-S8	Bolt (arm to frame)	4
33846-S8	Nut (arm to frame bolt)	4
34809-S8	Lockwasher (arm to frame bolt)	4
23638-S7	Bolt (support to frame)	2
33802-S8	Nut (support to frame bolt)	2
34803-S7	Lockwasher (support to frame bolt)	2

1935

PASSENGER EXCEPT SEDAN DELIVERY



P-220

+68 17757	Bar	1
+68 17786-A	Arm-RH	1
68 17787-A	Arm-LH	1
23428-S2	Bolt (arm to bar)-outer	2
33802-S8	Nut (arm to bar bolt)-outer	2
34808-S8	Lockwasher (arm to bar bolt)-outer	2
11A 17758	Bolt (arm to bar)-inner-without guards	2
24453-S8	Bolt (arm to bar)-inner-with guards	2
33846-S8	Nut (arm to bar bolt)-inner	2
34849-S2	Lockwasher (arm to bar bolt)-inner	2

1935

SEDAN DELIVERY

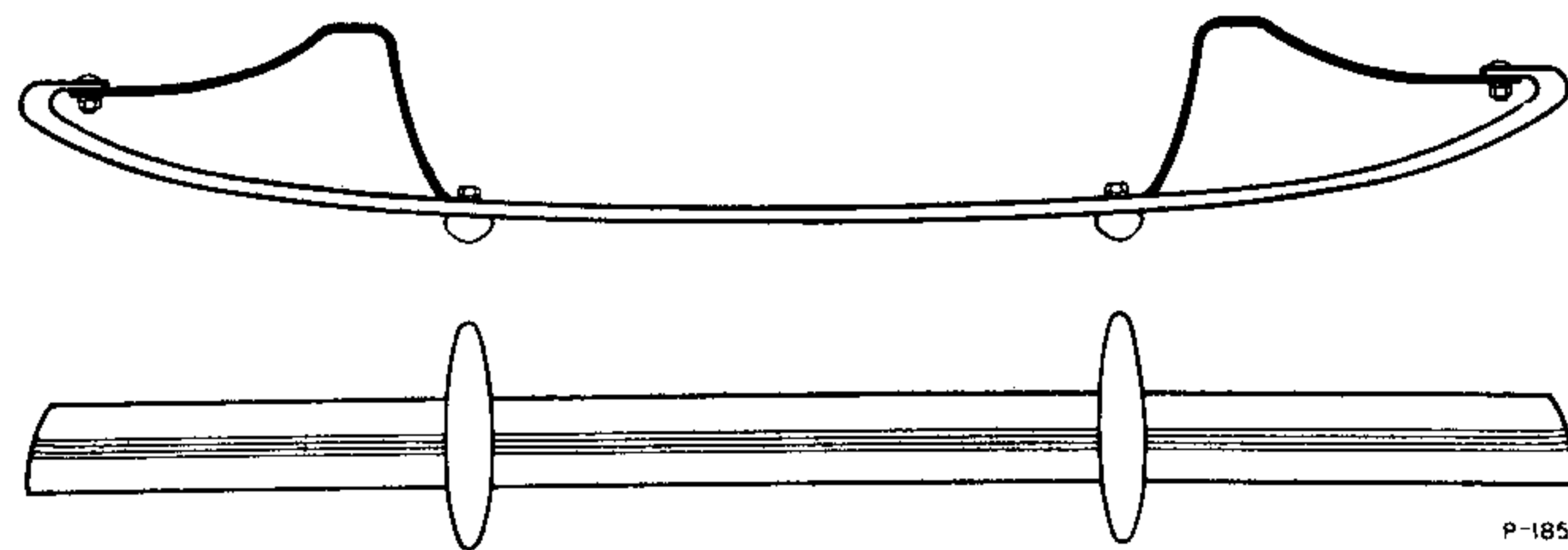

P-185

+68 17757	Bar	1
48 17787-B	Arm	2
23428-S2	Bolt (arm to bar)-outer	2
33802-S8	Nut (arm to bar bolt)-outer	2
34808-S8	Lockwasher (arm to bar bolt)-outer	2
24453-S8	Bolt (arm to bar)-inner-with guards	2
34849-S2	Lockwasher (arm to bar)-inner	2

CHASSIS PARTS CATALOGUE

PART NUMBER	PART NAME	NO. REQ'D	PART NUMBER	PART NAME	NO. REQ'D
-------------	-----------	-----------	-------------	-----------	-----------

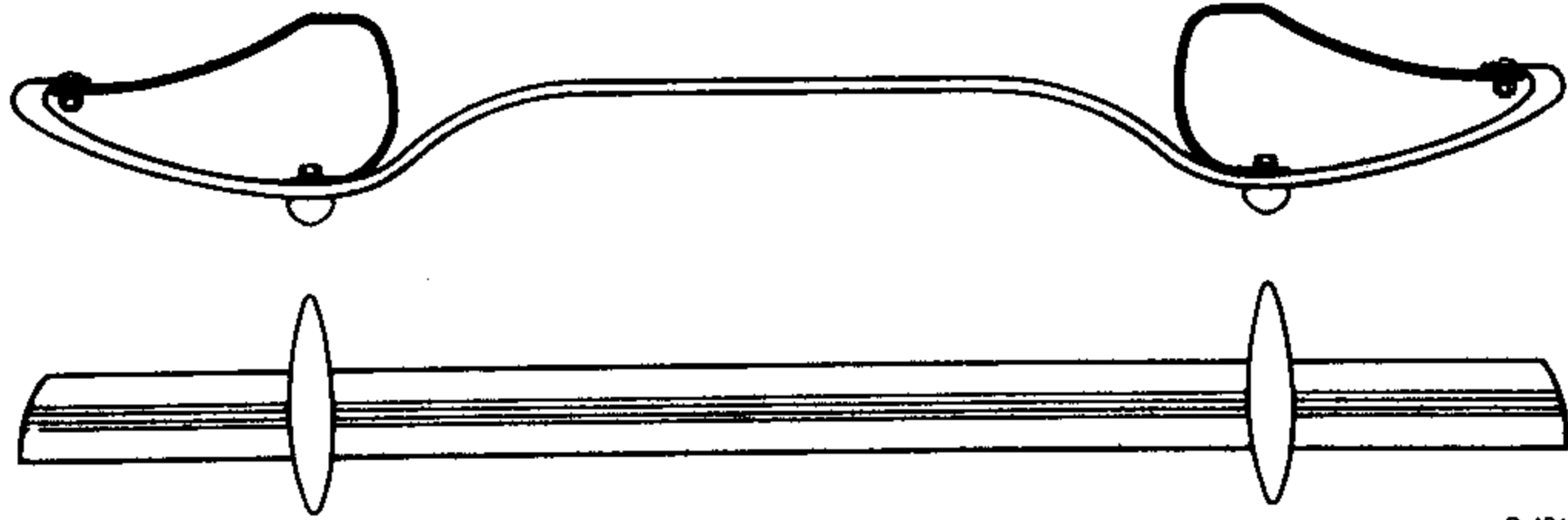
Rear Bumper
1935
SEDAN DELIVERY AND PANEL DELIVERY

P-191

+68 17906-B	Bar	1
68 17786-B	Arm-RH	1
68 17787-B	Arm-LH	1
23428-S2	Bolt (arm to bar)-outer	2
33802-S8	Nut (arm to bar bolt)-outer	2
34808-S8	Lockwasher (arm to bar bolt)-outer	2
24453-S8	Bolt (arm to bar)-inner-with guards	2
34849-S2	Lockwasher (arm to bar bolt)-inner	2

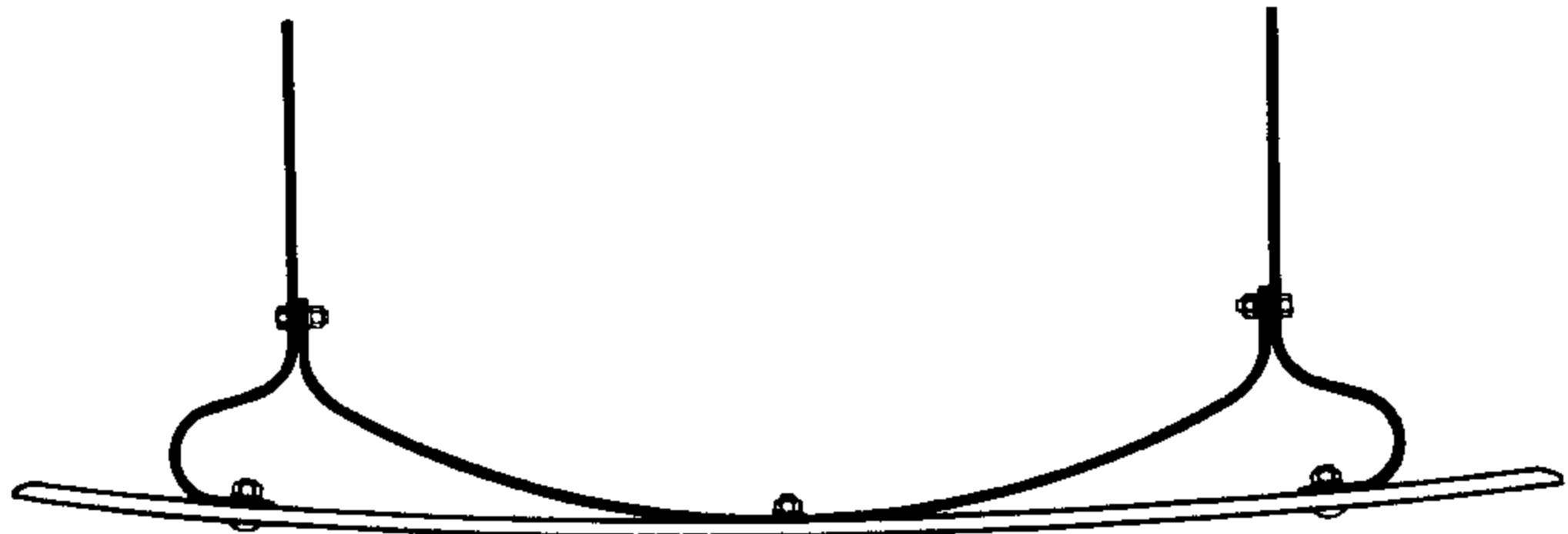
1935-36
TRUCKS

P-195

21T 17757-A	Bar	1
79 17955	Arm-RH	1
79 17956	Arm-LH	1
+79 17957	Arm reinforcement	1
BB 17758	Bolt (bar to arm and reinforcement)	3
33847-S8	Nut (bar to arm and reinforcement bolt)	3
34810-S7	Lockwasher (bar to arm and reinforcement bolt)	3
+20472-S	Bolt (reinforcement to arm)	2
33845-S8	Nut (reinforcement to arm bolt)	2
34809-S8	Lockwasher (reinforcement to arm bolt)	2
+BB 17910	Spacer (arm)	2
24493-S7	Bolt (arm to spacer to frame)	4
33846-S8	Nut (arm to spacer to frame bolt)	4
34809-S8	Lockwasher (arm to spacer to frame bolt)	4

† No Longer Supplied

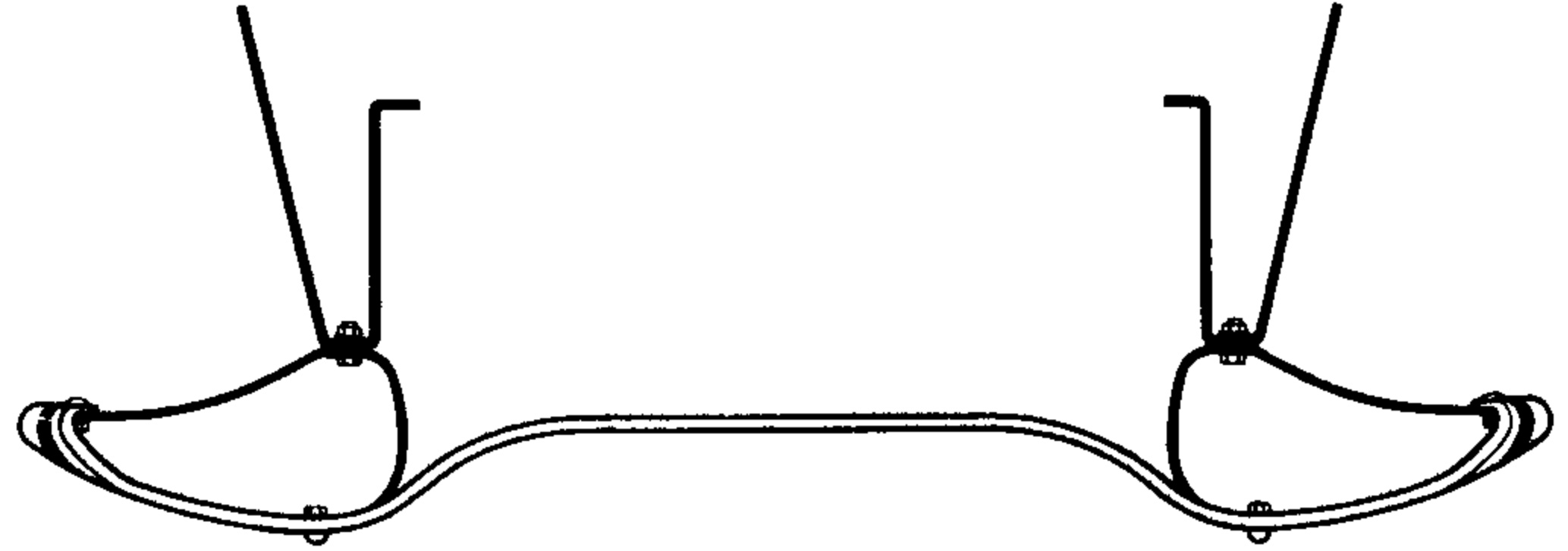
1936
PANEL DELIVERY

P-170

+68 17906-B	Bar	1
68 17786-B	Arm-RH	1
33846-S8	Nut (arm to bar)	2
34849-S2	Lockwasher (arm to bar)	2
68 17787-B	Arm-LH	1
+50 17957	Support (bumper arm)	2
50 17964	Support (bumper arm)	2
11A 17758	Bolt (arm to bar)	2
23588-S2	Bolt (rear bumper arm support to body)	2
33797-S7	Nut (rear bumper arm support to body)	2
34846-S2	Lockwasher (rear bumper arm support to body)	2
20449-S2	Bolt (rear bumper arms to support)	2

1936
PASSENGER EXCEPT CONVERTIBLE SEDAN, SEDAN DELIVERY AND STATION WAGON

P-168

+68 17757	Bar	1
+68 17786-A	Arm-RH	1
68 17787-A	Arm-LH	1
23428-S2	Bolt (bar to arm)-outer	2
33802-S8	Nut (bar to arm)-outer	2
34808-S8	Lockwasher (bar to arm)-outer	2
11A 17758	Bolt (bar to arm)-inner-without guards	2
24453-S8	Bolt (bar to arm)-inner-with guards	2
33846-S8	Nut (bar to arm)-inner	2
34849-S2	Lockwasher (bar to arm)-inner	2
20519-S2	Bolt (arm to brace)	2
21837-S2	Bolt (arm to brace)	2
33846-S8	Nut (arm to brace)	2
34809-S8	Lockwasher (arm to brace)	2



CHASSIS PARTS CATALOGUE

PART NUMBER	PART NAME	NO. REQ'D	PART NUMBER	PART NAME	NO. REQ'D
-------------	-----------	-----------	-------------	-----------	-----------

Rear Bumper

1936

PICKUP

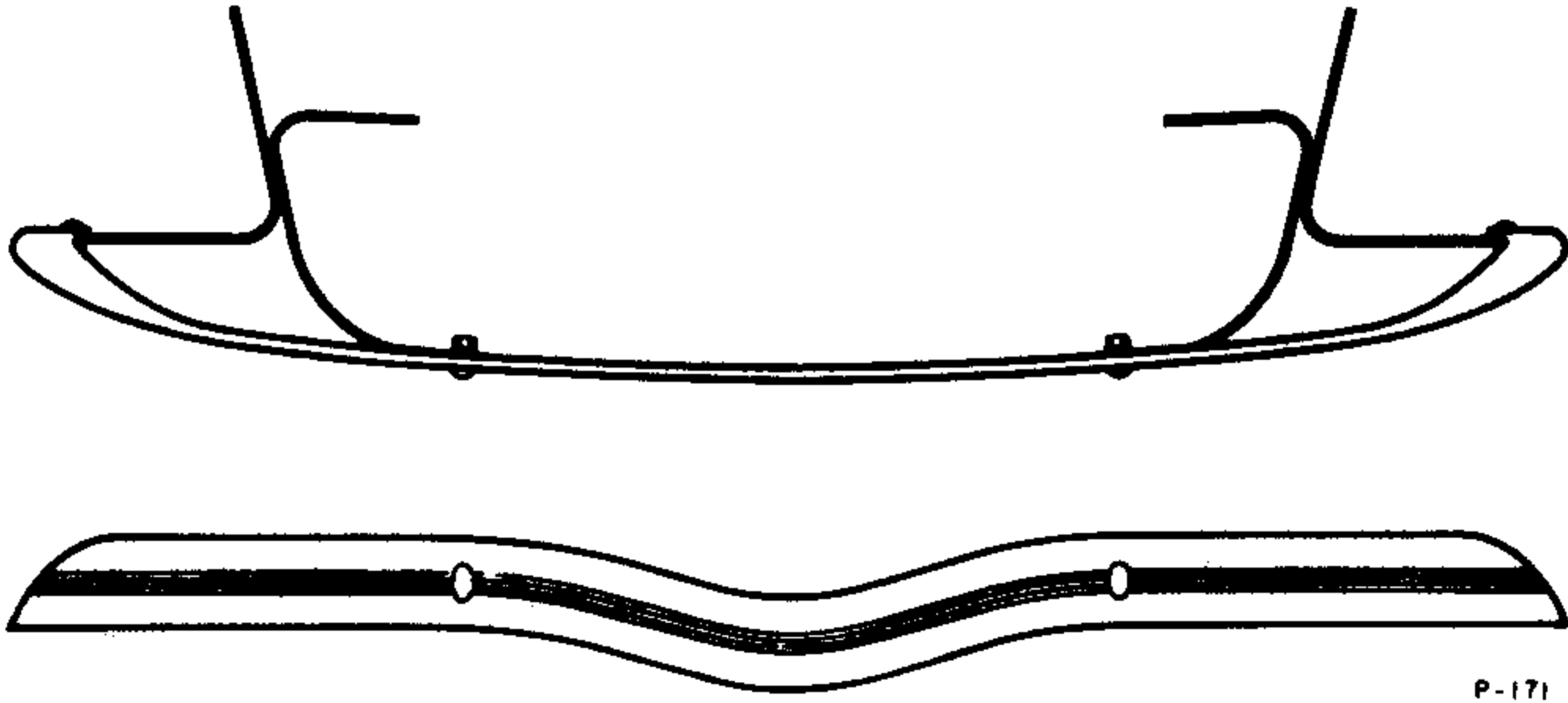

P-171

+68 17757	Bar	1
+67 17786	Arm (outer)-RH	1
67 17787	Arm (outer)-LH	1
+67 17795	Arm (inner)-RH	1
67 17796	Arm (inner)-LH	1
23428-S2	Bolt (outer arm to bar)	2
33802-S8	Nut (outer arm to bar bolt)	2
34808-S8	Lockwasher (outer arm to bar bolt)	2
11A 17758	Bolt (inner arm to bar)-w/o guards	2
33846-S8	Nut (inner arm to bar bolt)	2
34849-S2	Lockwasher (inner arm to bar bolt)	2
20423-S2	Bolt (arms to frame)	6
33846-S8	Nut (arms to frame bolt)	6
34849-S2	Lockwasher (arms to frame bolt)	6
23411-S2	Bolt (outer arm to inner arm)	2
33800-S8	Nut (outer to inner arm bolt)	2
34847-S7	Lockwasher(outer to inner arm bolt)	2

1936

CONVERTIBLE SEDAN

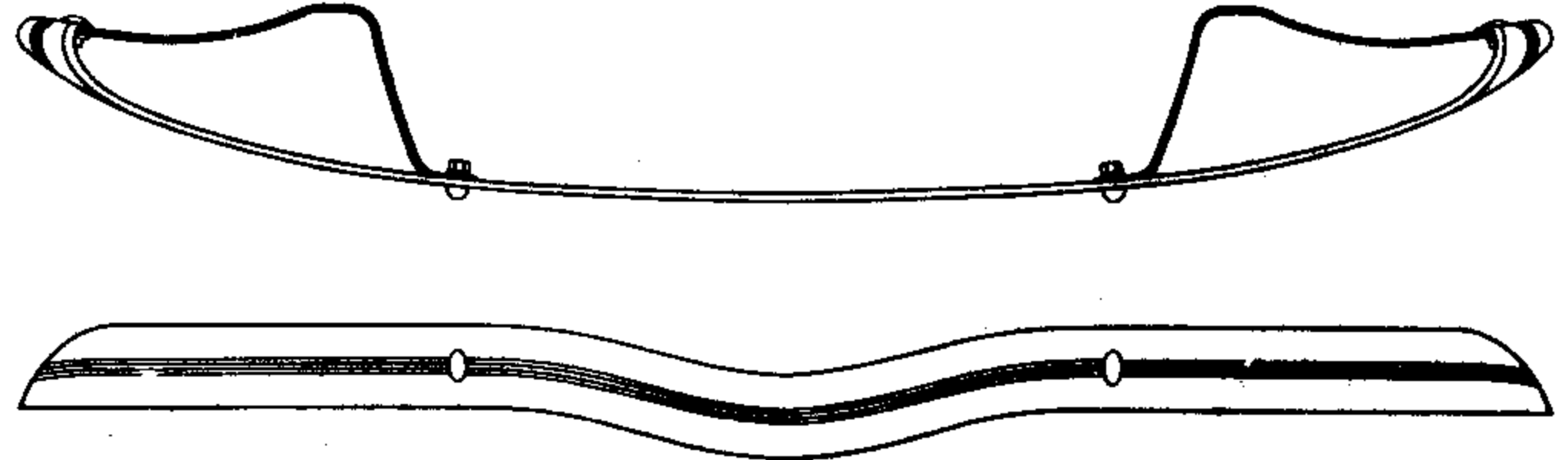

P-172

+68 17757	Bar	1
68 17786-C	Arm-RH	1
68 17787-C	Arm-LH	1
21813-S2	Bolt (rear bumper arm to rear bumper brace)	2
21837-S2	Bolt (rear bumper arm to brace)	2
33846-S8	Nut (arm to brace)	2
34809-S8	Lockwasher (arm to brace)	2
23428-S2	Bolt (bar to arm)-outer	2
33802-S8	Nut (bar to arm)-outer	2
34808-S8	Lockwasher (bar to arm)-outer	2
11A 17758	Bolt (bar to arm)-inner-w/o guards	2
24453-S8	Bolt (bar to arm)-inner w/guards	2
33846-S8	Nut (bar to arm)-inner	2
34849-S2	Lockwasher (bar to arm)-inner	2

1936

STATION WAGON

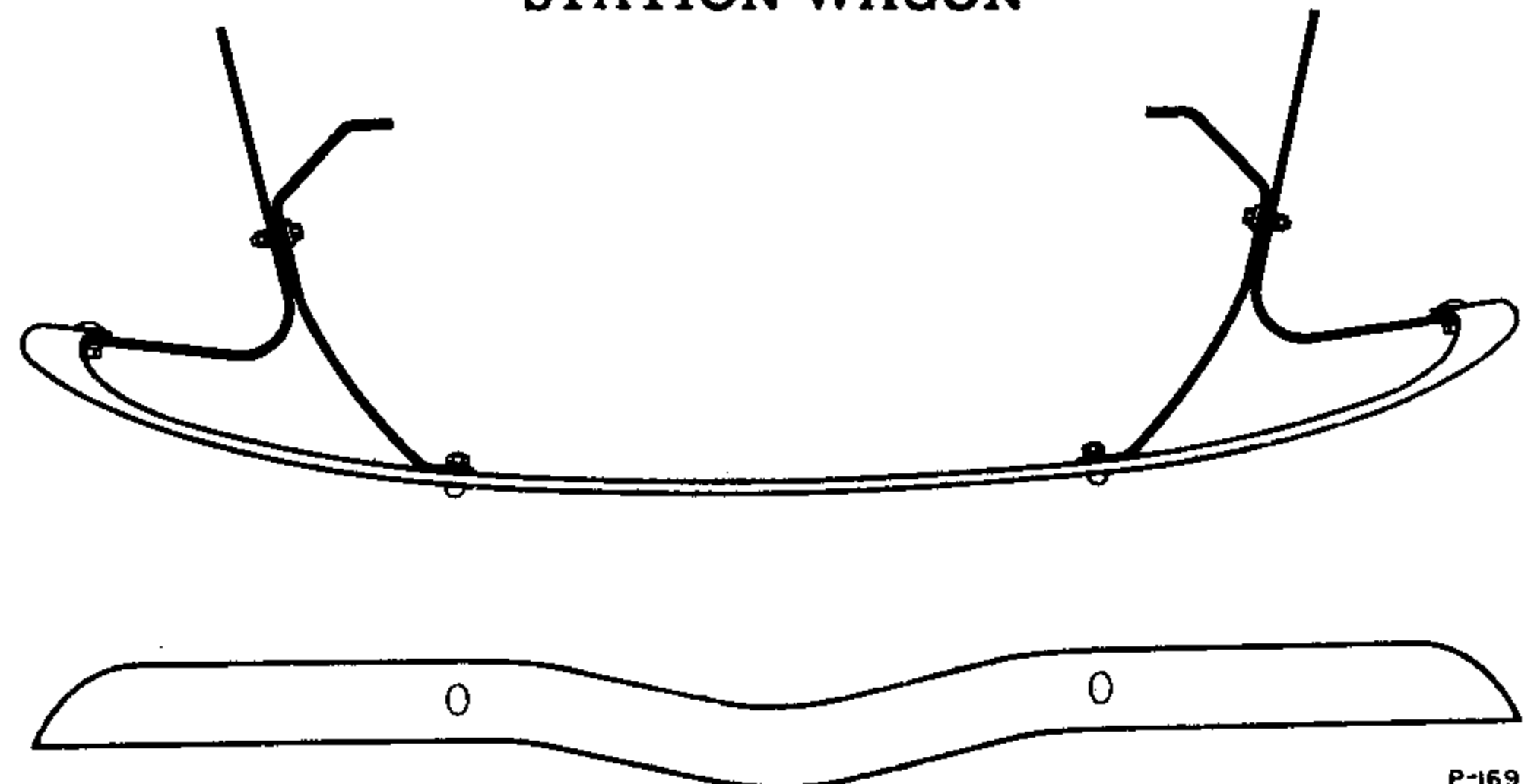

P-169

+68 17757	Bar	1
+68 17795	Arm (inner)-RH	1
68 17796	Arm (inner)-LH	1
+68 17786-D	Arm (outer)-RH	1
68 17787-D	Arm (outer)-LH	1
23428-S2	Bolt (bar to arm)-outer	2
33802-S8	Nut (bar to arm)-outer	2
34808-S8	Lockwasher (bar to arm bolt)-outer	2
11A 17758	Bolt (bar to inner arm)-w/o guards	2
33846-S8	Nut (bar to arm bolt)-inner	2
34849-S2	Lockwasher (bar to arm bolt)-inner	2
24453-S8	Bolt (bar to arm)-inner-w/guards	2
24554-S7	Bolt (rear bumper to spacer to bumper brace)	2
34809-S8	Lockwasher	2
+48 17790	Spacer (rear bumper)	2
351505-S18	Spacer washer	2
+351508-S	Spacer washer	2
20418-S	Bolt (inner to outer arm)	2
33799-S7	Nut (inner to outer arm bolt)	2
34847-S8	Lockwasher (inner to outer arm)	2
34707-S2	Plain washer (inner to outer arm bolt)	2
20423-S2	Bolt (bumper arms to frame)	6
33846-S8	Nut (rear bumper arms to frame)	6
34809-S8	Lockwasher (bumper arms to frame)	6

1936

SEDAN DELIVERY

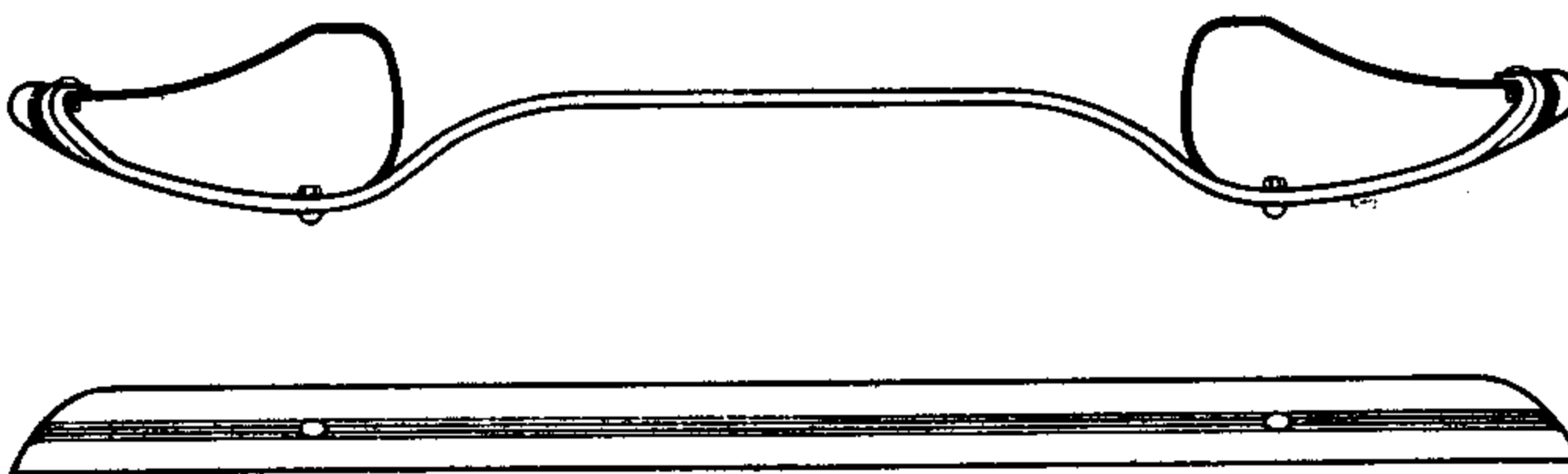

P-216

+68 17906-B	Bar	1
68 17786-B	Arm-RH	1
68 17787-B	Arm-LH	1
23428-S2	Bolt (bar to arm)-outer	2
33802-S8	Nut (bar to arm bolt)-outer	2
34808-S8	Lockwasher (bar to arm bolt)-outer	2
11A 17758	Bolt (bar to inner arm)-w/o guards	2
33846-S8	Nut (bar to arm bolt)-inner	2
34849-S2	Lockwasher (bar to arm bolt)-inner	2
24453-S8	Bolt (bar to arm)-inner-w/guards	2
24554-S7	Bolt (rear bumper to spacer to bumper brace)	2
34809-S8	Lockwasher	2
+48 17790	Spacer (rear bumper)	2
351505-S18	Spacer washer	2
+351508-S	Spacer washer	2

+ No Longer Supplied

CHASSIS PARTS CATALOGUE

PART NUMBER	PART NAME	NO. REQ'D	PART NUMBER	PART NAME	NO. REQ'D
-------------	-----------	-----------	-------------	-----------	-----------

Rear Bumper

1937

COMMERCIAL EXCEPT PLATFORM AND PANEL

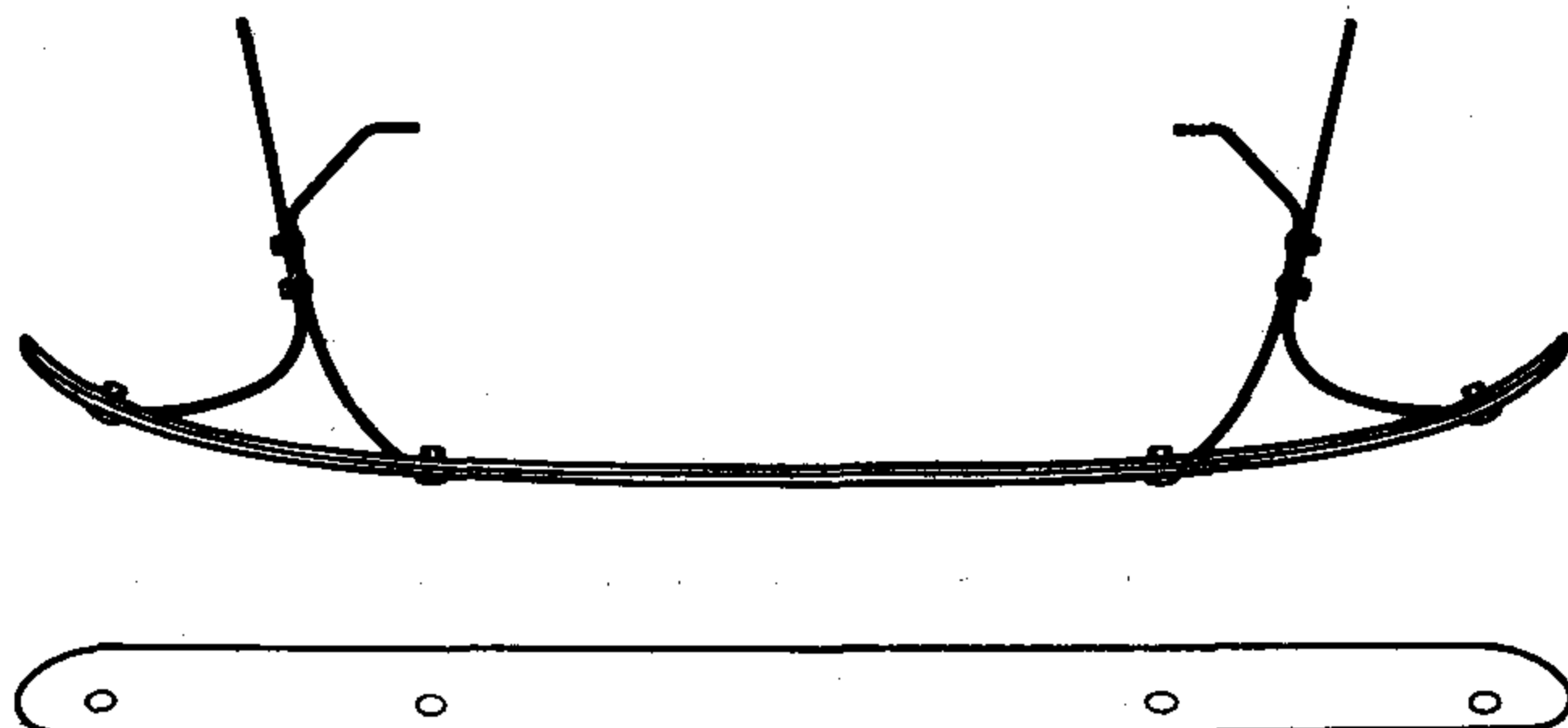

P-173

1937

COMMERCIAL WITH PLATFORM BODY

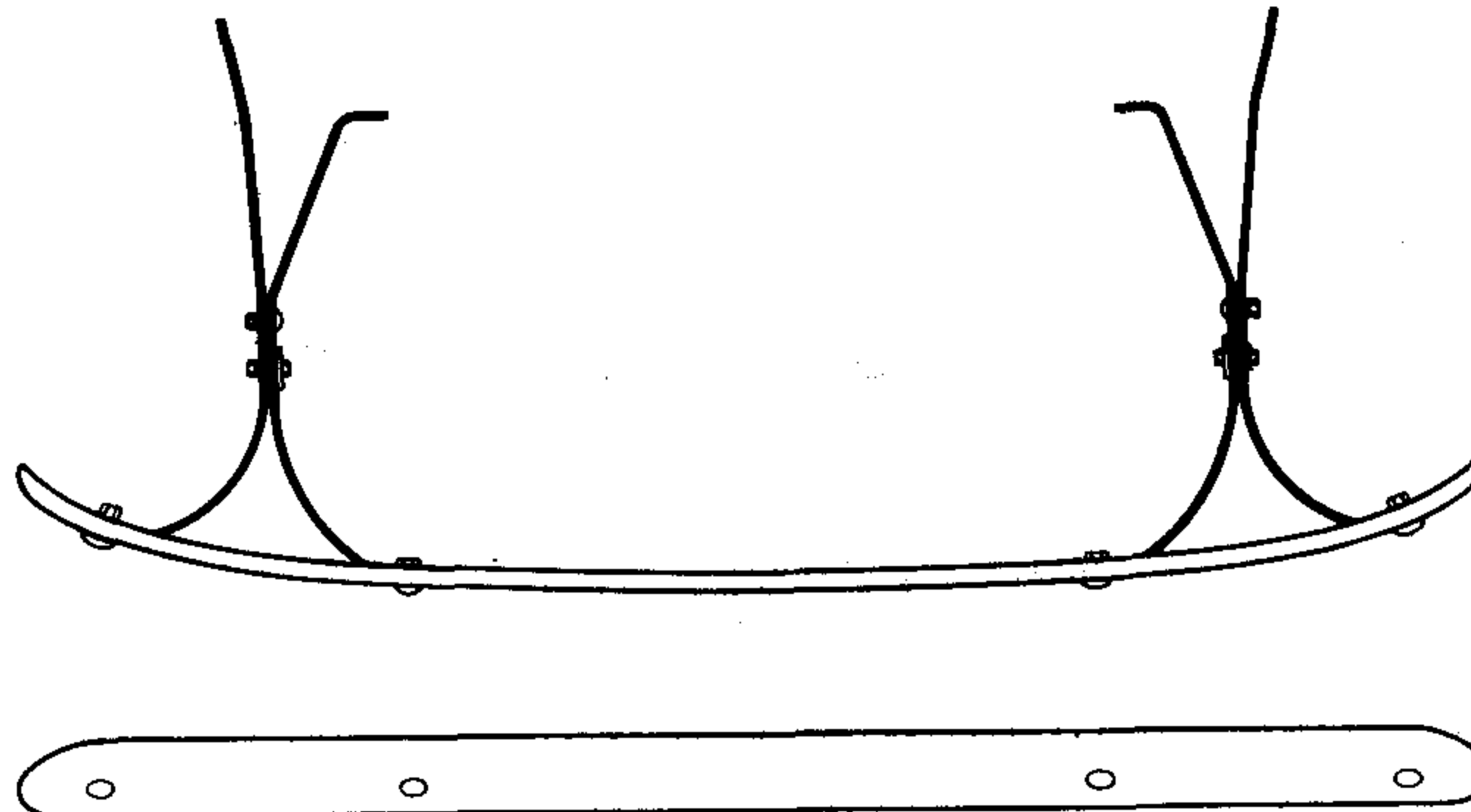

P-175

74 17757	Bar-replaced by 01A 17757-D	1
77 17795-D	Arm (outer)-RH	1
77 17796-D	Arm (outer)-LH	1
77 17787-D	Arm (inner)-RH	1
77 17788-D	Arm (inner)-LH	1
11A 17758	Bolt (outer arm to bar)	2
33802-S8	Nut (outer arm to bar bolt)	2
34808-S8	Lockwasher(outer arm to bar bolt)	2
11A 17758	Bolt (inner arm to bar)	2
33802-S8	Nut (inner arm to bar bolt)	2
34808-S8	Lockwasher(inner arm to bar bolt)	2
23411-S2	Bolt (inner to outer arm)	4
33800-S8	Nut (inner to outer arm bolt)	4
34847-S8	Lockwasher (inner to outer arm)	4
20423-S2	Bolt (arm to frame)	6
33846-S8	Nut (arm to frame bolt)	6
34849-S2	Lockwasher (arm to frame bolt)	6

74 17757	Bar-replaced by 01A 17757-D	1
01C 17795-B	Arm (outer)	2
77 17787-C	Arm (inner)-RH	1
77 17788-C	Arm (inner)-LH	1
11A 17758	Bolt (outer arm to bar)	2
33802-S8	Nut (outer arm to bar bolt)	2
34808-S8	Lockwasher (outer arm to bar bolt)	2
11A 17758	Bolt (inner arm to bar)	2
33802-S8	Nut (inner arm to bar bolt)	2
34808-S8	Lockwasher (inner arm to bar bolt)	2
20449-S2	Bolt (inner to outer arm)-nearest bar	2
23411-S2	Bolt (inner to outer arm)	2
33800-S8	Nut (inner to outer arm bolt)	4
34847-S8	Lockwasher (inner to outer arm bolt)	4
20423-S2	Bolt (arm to frame)	6
33846-S8	Nut (arm to frame)	6
34809-S8	Lockwasher (arm to frame)	6
77 17918-B	Support (bumper arm)	2
33846-S8	Nut (rear bumper arm support to body)	3
34809-S8	Lockwasher (rear bumper arm support to body)	3
24554-S7	Bolt (rear bumper arm support to body to rear lamp support bracket)	1
33846-S8	Nut (rear bumper arm support to body to rear lamp support bracket)	1
34809-S8	Lockwasher (rear bumper arm support to body to rear lamp support bracket)	1
†23558-S2	Bolt (bumper arm support to side sill)	2
34846-S2	Lockwasher (bumper arm support to side sill)	2
33797-S7	Nut (bumper arm support to side sill)	2

1937

SEDAN DELIVERY

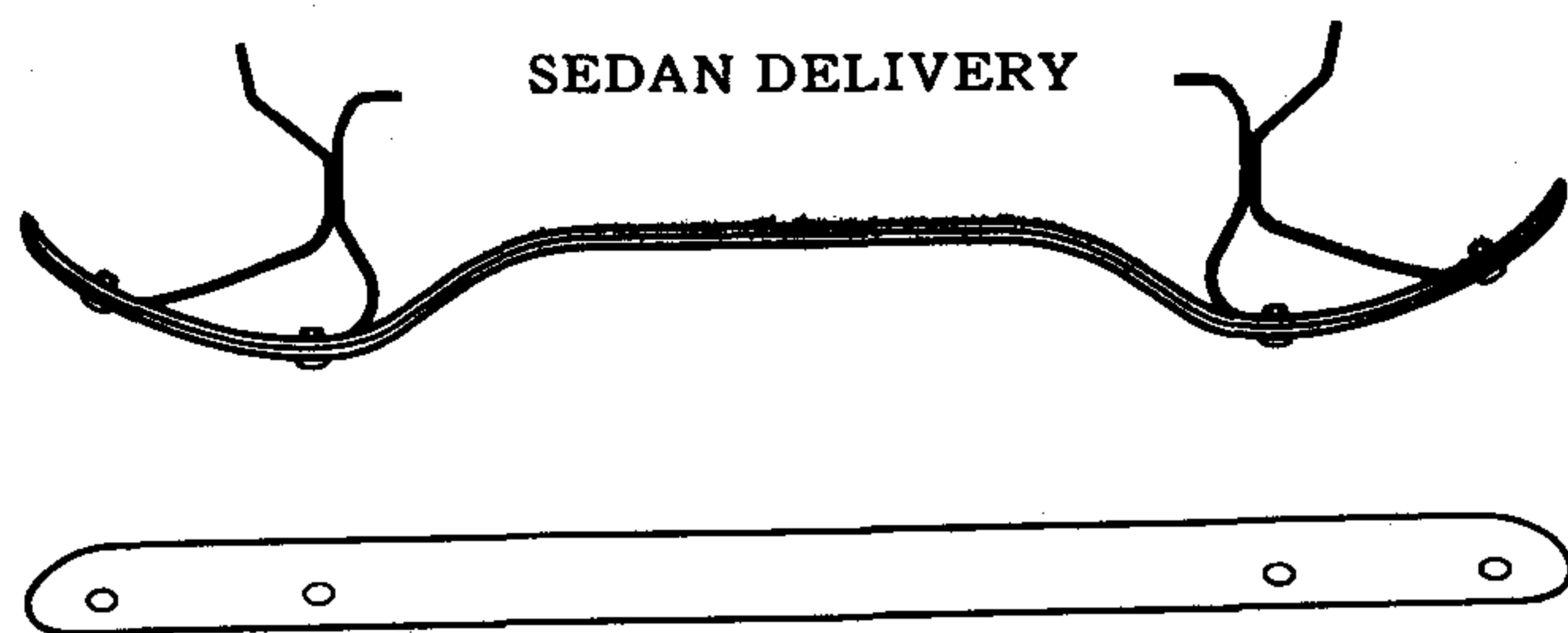

P-177

01A 17757-D	Bar	1
78 17795-B	Arm (outer)-RH	1
†78 17796-B	Arm (outer)-LH	1
78 17787-B	Arm (inner)-RH	1
78 17788-B	Arm (inner)-LH	1
11A 17758	Bolt (outer arm to bar)	2
33802-S8	Nut (outer arm to bar bolt)	2
34808-S8	Lockwasher(outer arm to bar bolt)	2
11A 17758	Bolt (inner arm to bar)	2
33802-S8	Nut (inner arm to bar bolt)	2
34808-S8	Lockwasher(inner arm to bar bolt)	2
23411-S2	Bolt (inner to outer arm)	2
33800-S8	Nut (inner to outer arm bolt)	2
34847-S8	Lockwasher(inner to outer arm bolt)	2
20423-S2	Bolt (arm to frame)	6
33846-S8	Nut (arm to frame bolt)	6
34849-S2	Lockwasher (arm to frame bolt)	6

† No Longer Supplied

CHASSIS PARTS CATALOGUE

PART NUMBER	PART NAME	NO. REQ'D	PART NUMBER	PART NAME	NO. REQ'D
-------------	-----------	-----------	-------------	-----------	-----------

Rear Bumper

1937

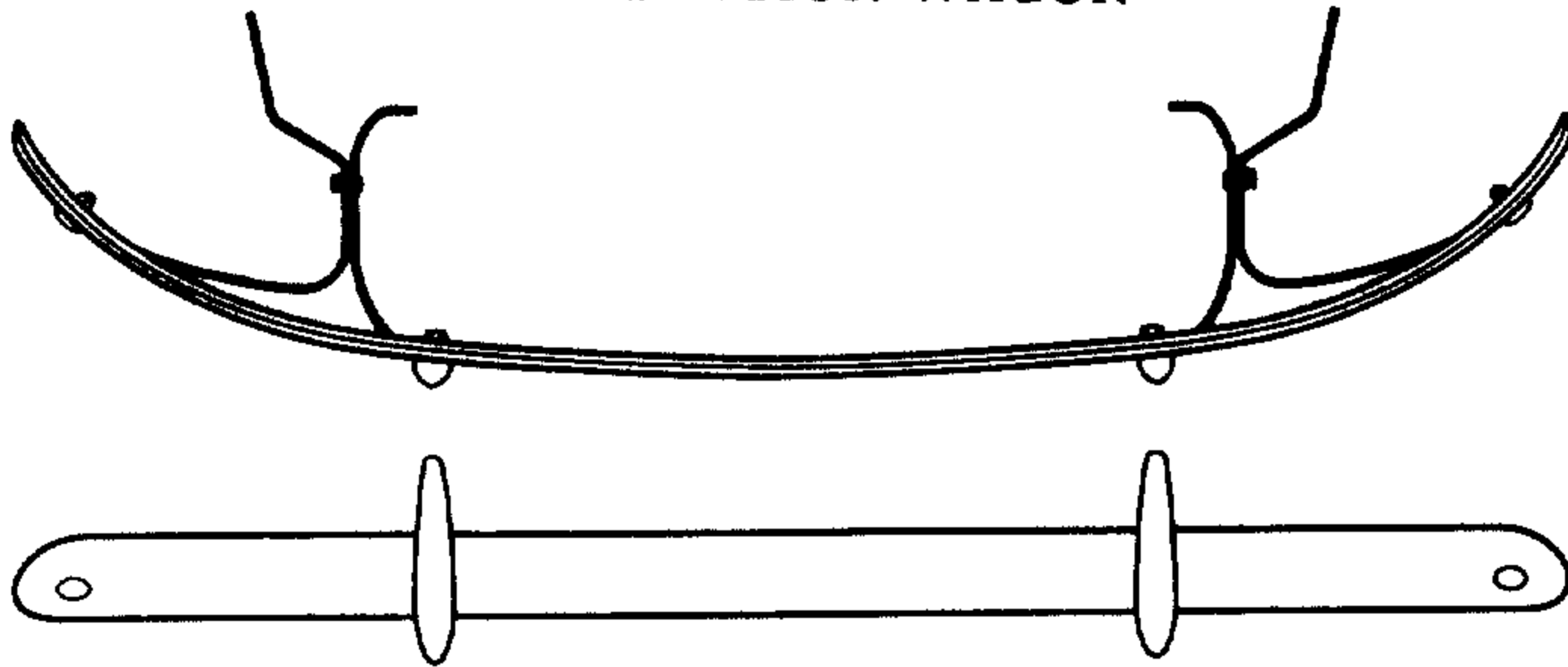
PASSENGER EXCEPT SEDAN DELIVERY
AND STATION WAGON

P-164

74 17906	Bar -repl. by 01A 17757-C	1
†78 17795-A	Arm (outer)-RH	1
78 17796-A	Arm (outer)-LH	1
78 17787-A	Arm (inner)-RH	1
78 17788-A	Arm (inner)-LH	1
11A 17758	Bolt (outer arm to bar)	2
33802-S8	Nut (outer arm to bar bolt)	2
34808-S8	Lockwasher(outer arm to bar bolt)	2
24453-S7	Bolt (inner arm to bar)	2
34849-S2	Lockwasher(inner arm to bar bolt)	2
23411-S2	Bolt (inner to outer arm)	2
33800-S8	Nut (inner to outer arm bolt)	2
34847-S8	Lockwasher (inner to outer arm bolt)	2
20423-S2	Bolt (arm to frame)	6
33846-S8	Nut (arm to frame bolt)	6
34849-S2	Lockwasher (arm to frame bolt)	6

1937

TRUCKS

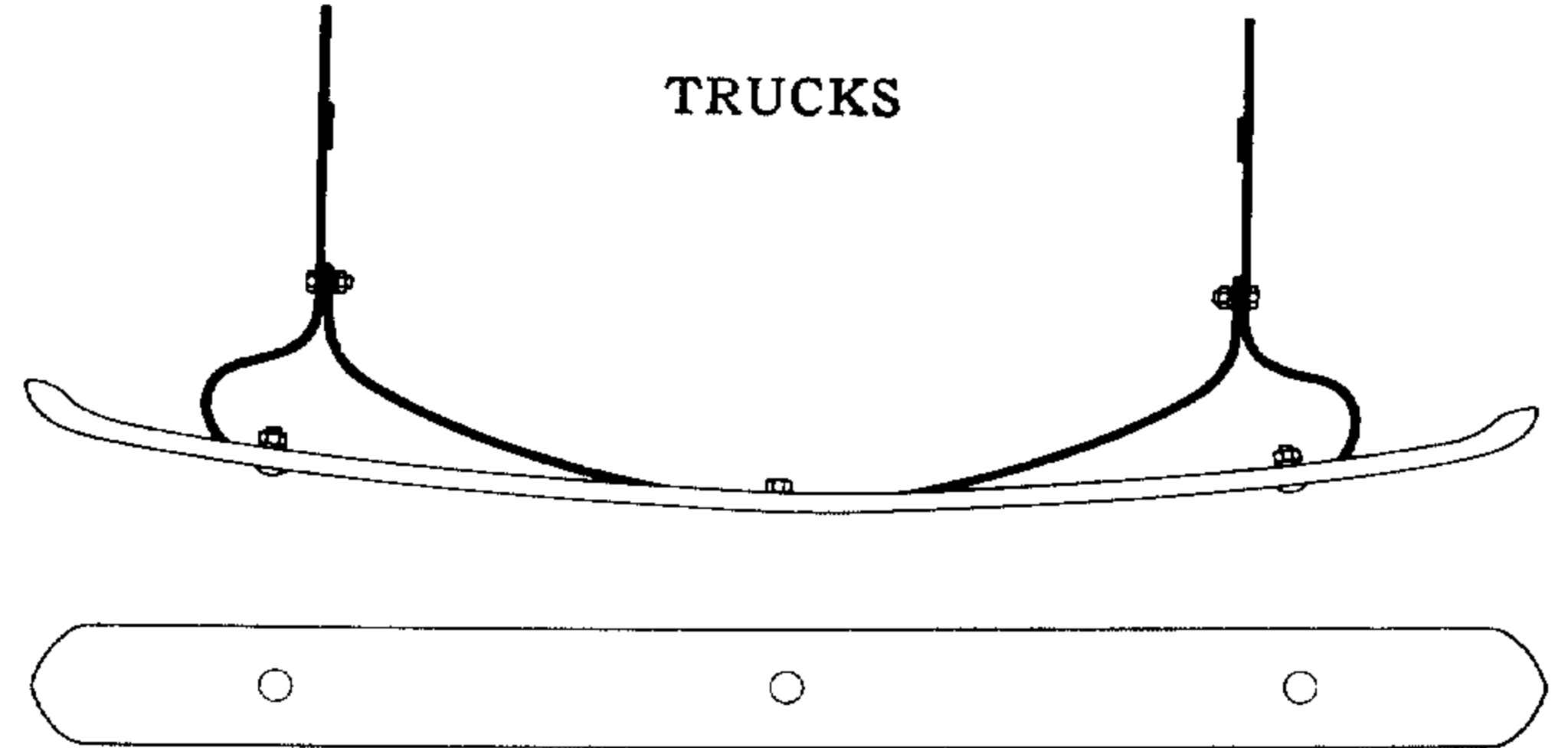

P-174

21T 17757-A	Bar	1
79 17955	Arm-RH	1
79 17956	Arm-LH	1
†79 17957	Reinforcement (bar)	1
BB 17758	Bolt (arm to bar)	2
33847-S7	Nut (arm to bar bolt)	2
34810-S7	Lockwasher (arm to bar bolt)	2
BB 17758	Bolt (reinforcement to bar)	1
34847-S8	Nut (reinforcement to bar bolt)	1
34810-S7	Lockwasher (reinforcement to bar bolt)	1
†20472-S	Bolt (reinforcement to arm)	2
33845-S8	Nut (reinforcement to arm)	2
34849-S2	Lockwasher (reinforcement to arm)	2
24493-S7	Bolt (arm to frame)	4
33846-S8	Nut (arm to frame bolt)	4
34849-S2	Lockwasher (arm to frame bolt)	4
†BB 17910	Spacer	2

1937

PANEL DELIVERY

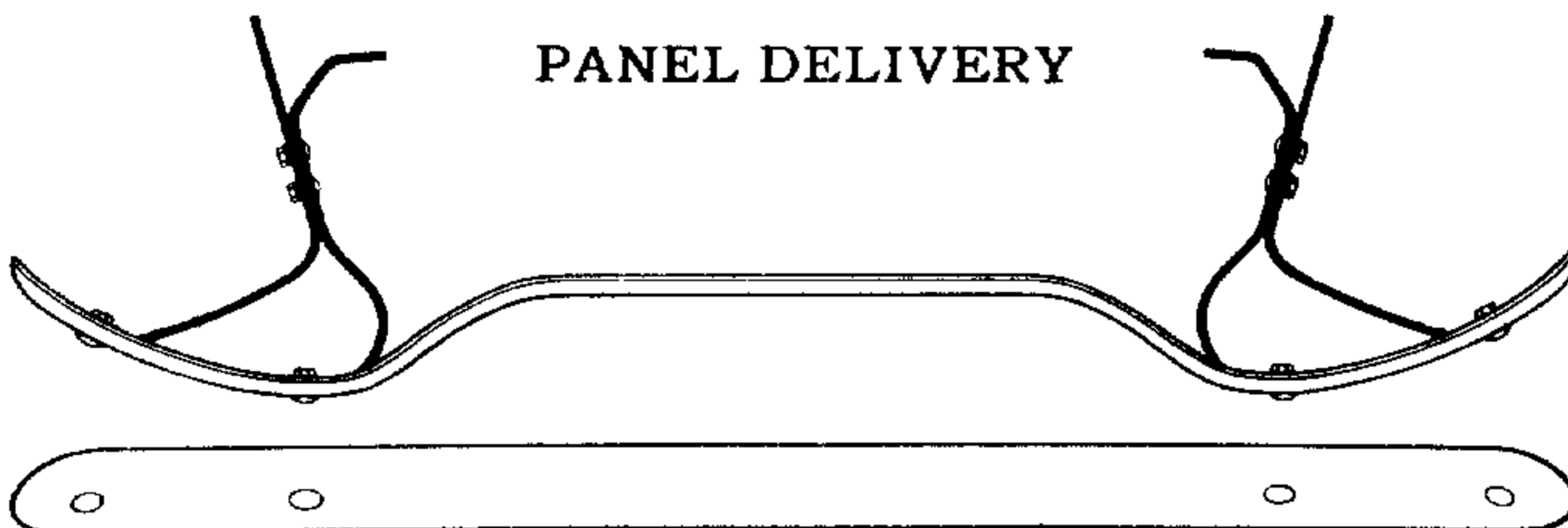

P-210

01A 17757-D	Bar	1
77 17795-B	Arm (outer)-RH	1
77 17796-B	Arm (outer)-LH	1
77 17787-B	Arm (inner)-RH	1
77 17788-B	Arm (inner)-LH	1
11A 17758	Bolt (outer arm to bar)	2
34802-S7	Nut (outer arm to bar bolt)	2
34808-S8	Lockwasher(outer arm to bar bolt)	2
11A 17758	Bolt (inner arm to bar)	2
33802-S8	Nut (inner arm to bar bolt)	2
34808-S8	Lockwasher(inner arm to bar bolt)	2
23456-S7	Bolt (inner to outer arm)-nearest bar	2
23411-S2	Bolt (inner to outer arm)	2
33800-S8	Nut (inner to outer arm bolt)	4
34847-S8	Lockwasher(inner to outer arm bolt)	4
20423-S2	Bolt (arm to frame)	6
33846-S8	Nut (arm to frame bolt)	6
34809-S8	Lockwasher (arm to frame bolt)	6

1938

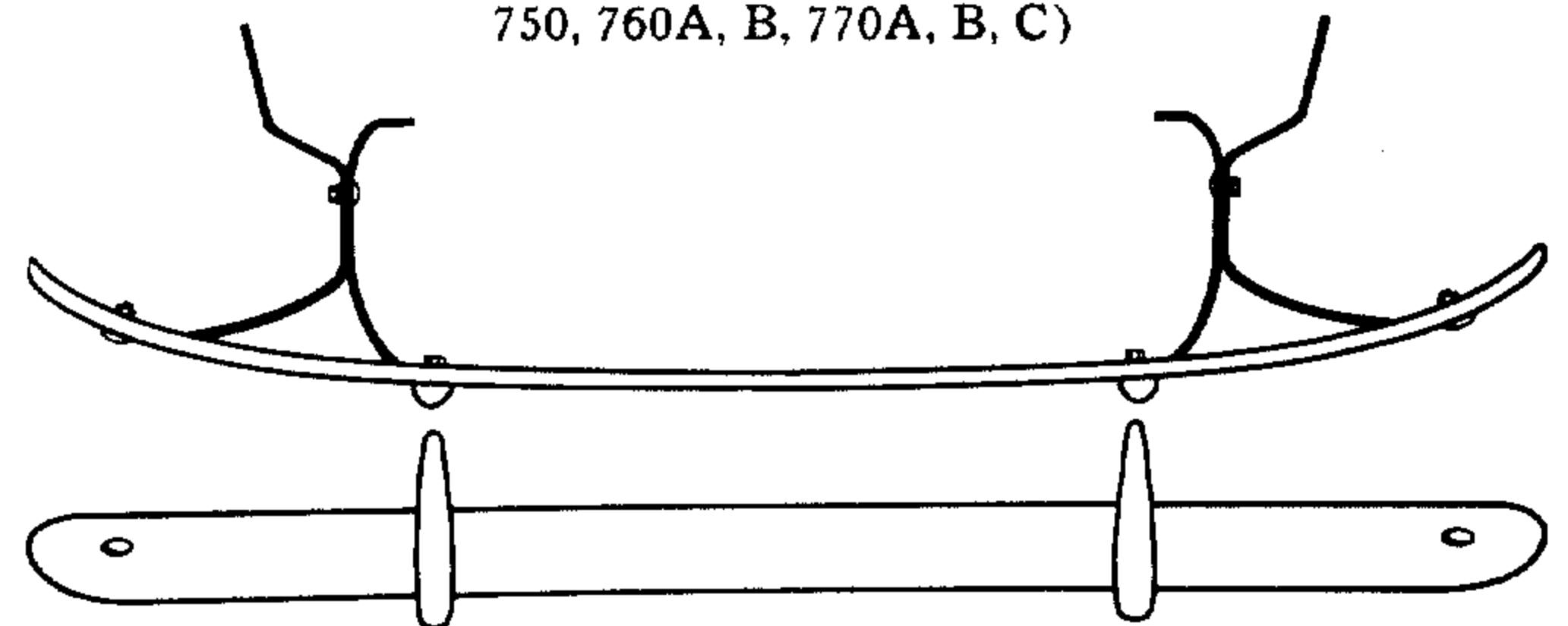
PASSENGER (BODY TYPES 700C, 720, 730C, 740,
750, 760A, B, 770A, B, C)

P-290

74 17757	Bar-repl. by 01A 17757-D	1
91A 17787-A	Arm (inner)	2
91A 17795-A	Arm (outer)	2
81A 17996-A	Guard (bumper)	2
11A 17758	Bolt (outer arm to bar)	2
†20472-S	Bolt (arm to frame)	6
24453-S7	Bolt (inner arm to bar to guard)	2
23411-S2	Bolt (inner to outer arm)	2
33800-S8	Nut (inner to outer arm bolt)	2
33802-S8	Nut (outer arm to bar bolt)	2
33845-S8	Nut (rear bumper to frame bolt)	6
44736-S8	Washer (inner arm to frame)-flat	2
34847-S8	Lockwasher (inner to outer arm)	2
34808-S8	Lockwasher (outer arm to bar)	2
34849-S2	Lockwasher (inner arm to bar)	2
34849-S2	Lockwasher (arm to frame)	6

† No Longer Supplied

CHASSIS PARTS CATALOGUE

PART NUMBER	PART NAME	NO. REQ'D	PART NUMBER	PART NAME	NO. REQ'D
-------------	-----------	-----------	-------------	-----------	-----------

Rear Bumper

1938

TRUCK WITH PANEL BODY

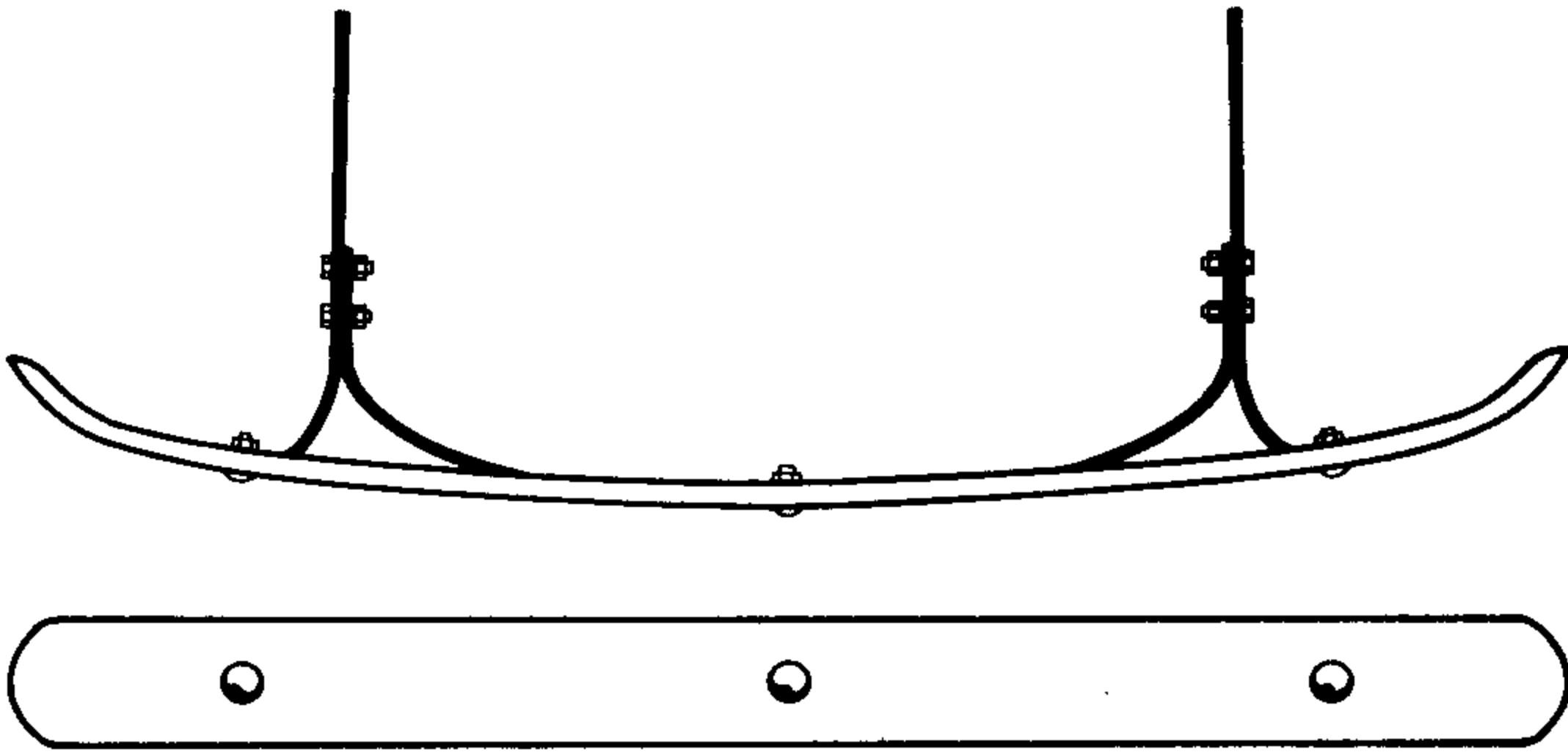

P-284

1938-39

PANEL DELIVERY

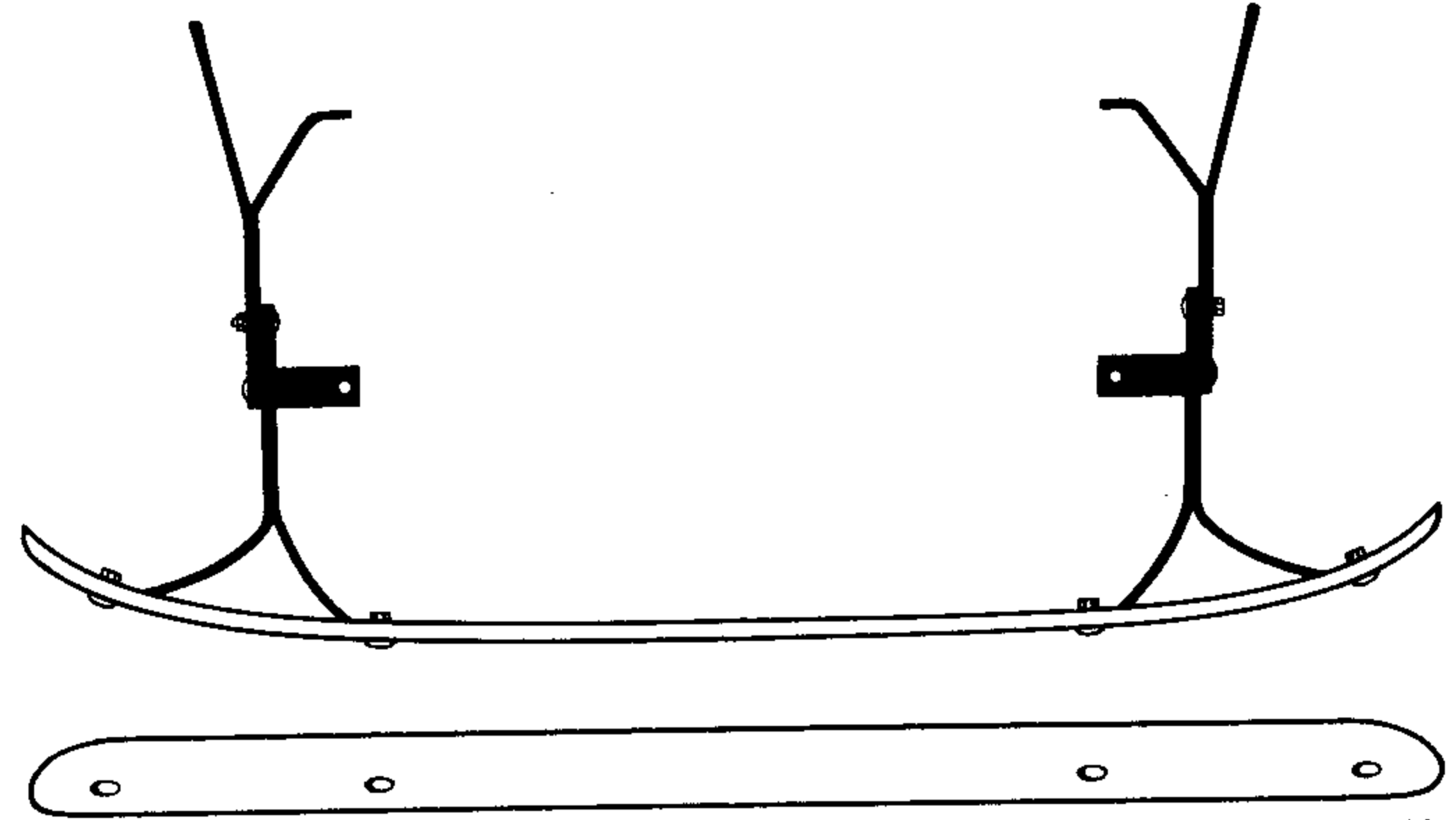

P-261

21T 17906	Bar	1
81T 17955	Arm (outer)-RH	1
81T 17956	Arm (outer)-LH	1
81T 17957	Reinforcement (bar)	1
BB 17758	Bolt (outer arms to bar)	2
+20472-S	Bolt (arm to frame)	4
+20472-S	Bolt (reinforcement to arm)	4
33845-S8	Nut (arm to frame bolt)	4
33845-S8	Nut (reinforcement to arm bolt)	4
33847-S7	Nut (outer arm to bar bolt)	2
33847-S7	Nut (reinforcement to bar bolt)	1
34810-S7	Lockwasher (outer arm to bar bolt)	2
34810-S7	Lockwasher (reinforcement to bar)	1
34849-S2	Lockwasher (arm to frame bolt)	4
34849-S2	Lockwasher (reinforcement to arm)	4
355743-S2	Bolt (reinforcement to bar)	1

1938-39

SEDAN DELIVERY

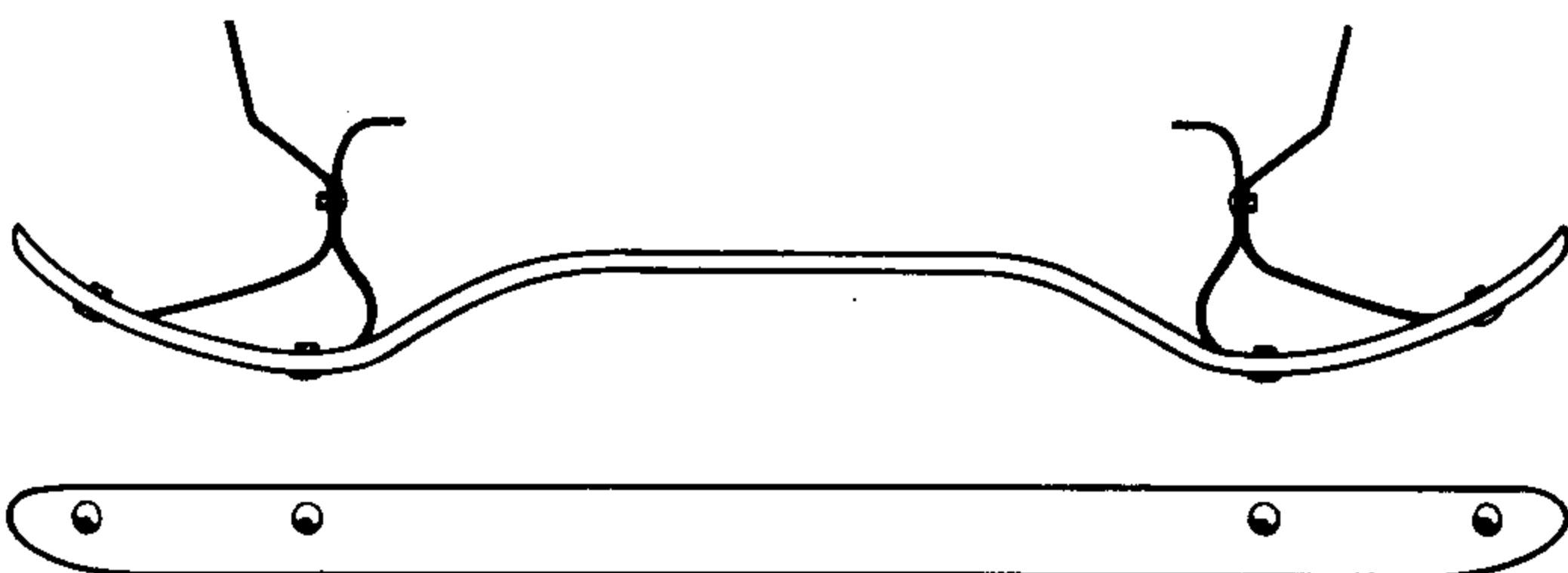

P-268

01A 17757-D	Bar	1
78 17787-B	Arm (inner)-RH	1
78 17788-B	Arm (inner)-LH	1
78 17795-B	Arm (outer)-RH	1
+78 17796-B	Arm (outer)-LH	1
11A 17758	Bolt (arms to bar)	4
+20472-S	Bolt (arm to frame)	6
23411-S2	Bolt (inner to outer arm)	2
33800-S8	Nut (inner to outer arm bolt)	2
33802-S8	Nut (arms to bar bolt)	4
33845-S8	Nut (arm to frame bolt)	6
44736-S8	Washer (inner arm to frame)-flat	2
34807-S2	Lockwasher (inner to outer arm)	2
34808-S8	Lockwasher (arm to bar bolt)	4
34849-S2	Lockwasher (arm to frame bolt)	6

74 17757	Bar-repl. by 01A 17757-D	1
11A 17758	Bolt (arm to bar)	4
+81C 17787-A	Arm (inner)-RH	1
01C 17788-A	Arm (inner)-LH	1
01C 17795-A	Arm (outer)-RH	1
01C 17796-A	Arm (outer)-LH	1
81C 17918	Support	2
81C 17925	Hanger (inner)-RH	1
81C 17926	Hanger (inner)-LH	1
81C 17958	Hanger (outer)-RH	1
+81C 17959	Hanger (outer)-LH	1
+20472-S	Bolt (arm to frame)	6
+20472-S	Bolt (support to frame)	2
24493-S7	Bolt (inner to outer arm)	4
33800-S8	Nut (inner to outer arm bolt)	4
33802-S8	Nut (arms to bar bolt)	4
33845-S8	Nut (arm to frame bolt)	6
33845-S8	Nut (support to frame bolt)	2
34808-S8	Lockwasher (arms to bar bolt)	4
34847-S8	Lockwasher (inner to outer arm)	4
34849-S2	Lockwasher (support to frame bolt)	2
34849-S2	Lockwasher (arm to frame bolt)	6

† No Longer Supplied

CHASSIS PARTS CATALOGUE

PART NUMBER	PART NAME	NO. REQ'D	PART NUMBER	PART NAME	NO. REQ'D
-------------	-----------	-----------	-------------	-----------	-----------

Rear Bumper

1938-39

COMMERCIAL EXCEPT PLATFORM AND PANEL

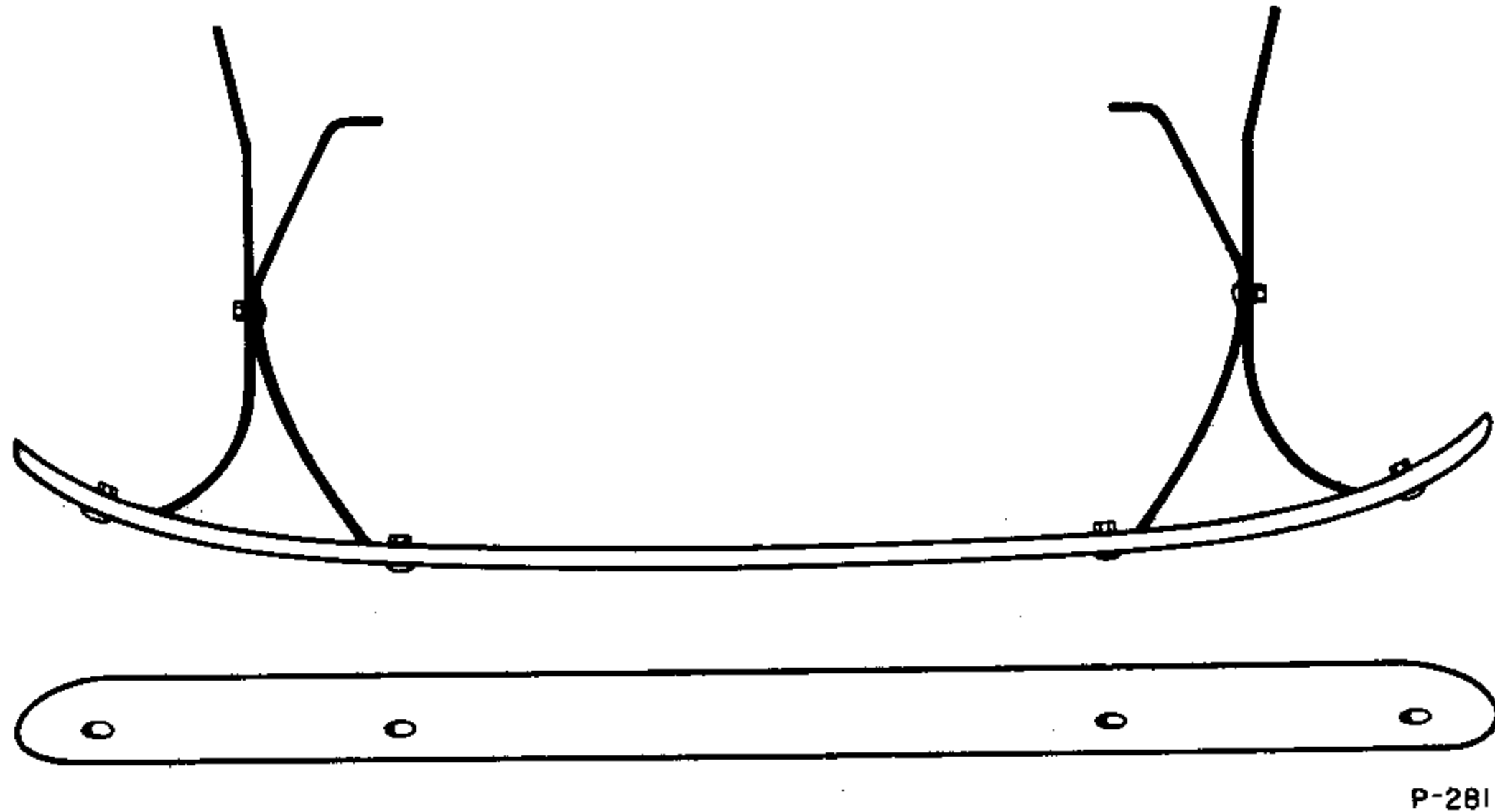

P-281

74 17757	Bar-repl. by 01A 17757-D	1
01C 17787-A	Arm (inner)-RH	1
01C 17788-A	Arm (inner)-LH	1
01C 17795-A	Arm (outer)-RH	1
01C 17796-A	Arm (outer)-LH	1
11A 17758	Bolt (arms to bar)	4
+20472-S	Bolt (arm to frame)	6
23428-S2	Bolt (inner to outer arm)	2
33802-S8	Nut (arms to bar bolt)	4
33802-S8	Nut (inner to outer arm bolt)	2
34808-S8	Lockwasher (arms to bar bolt)	4
34808-S8	Lockwasher (inner to outer arm)	2
33845-S8	Nut (arm to frame bolt)	6
34849-S2	Lockwasher (arm to frame bolt)	6

1938-39

COMMERCIAL WITH PLATFORM BODY

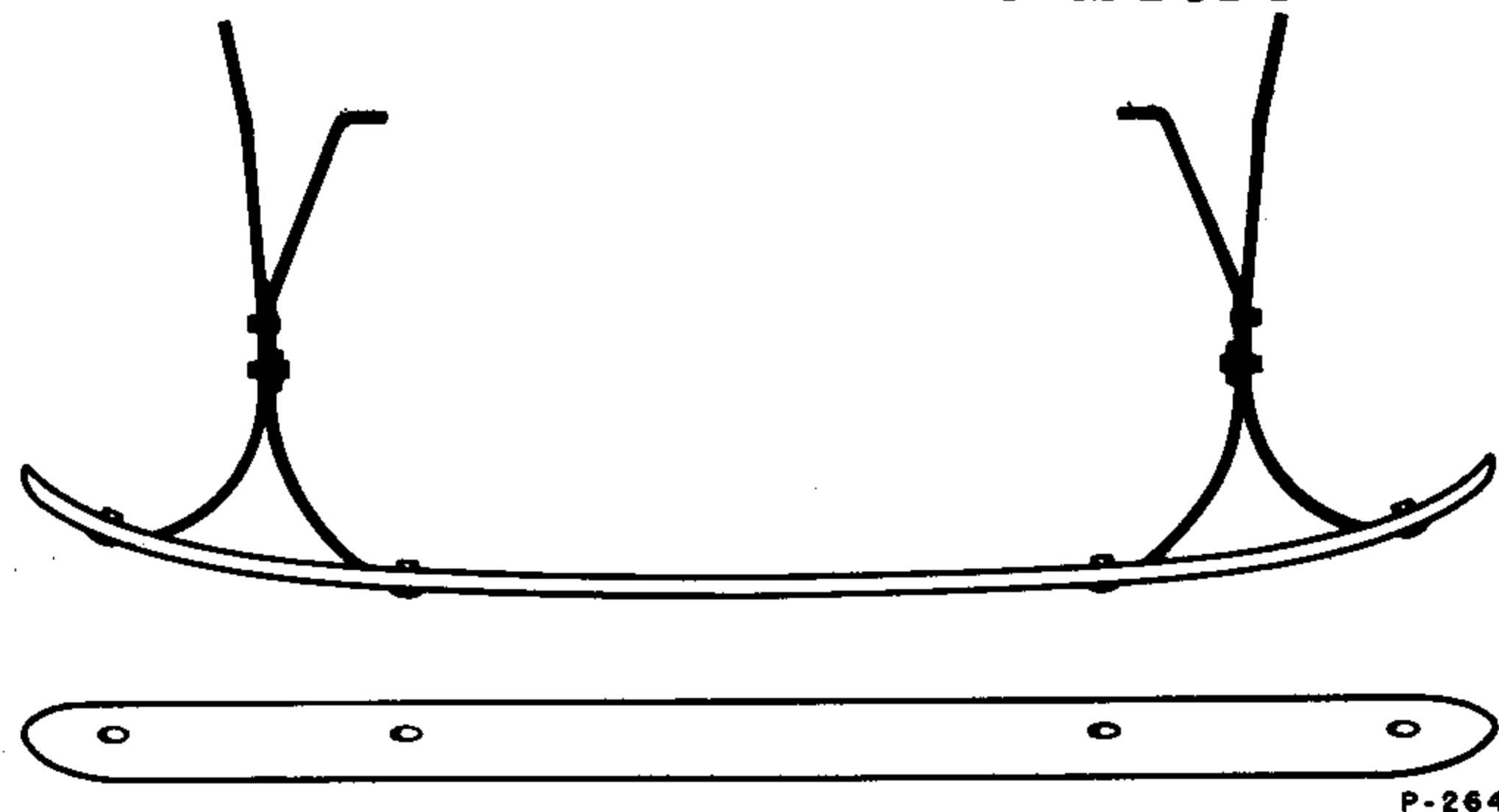

P-264

74 17757	Bar-repl. by 01A 17757-D	1
77 17787-C	Arm (inner)-RH	1
77 17788-C	Arm (inner)-LH	1
01C 17795-C	Arm (outer)	2
11A 17758	Bolt (arms to bar)	4
77 17918-B	Support (rear bumper arm)	2
20423-S2	Bolt (arm to frame)	6
20449-S2	Bolt (inner to outer arm)-nearest bar	2
23411-S2	Bolt (inner to outer arm)-farthest from bar	2
+23558-S2	Bolt (arm support to side sill)	4

† No Longer Supplied

33797-S7	Nut (bumper arm support to side sill)	4
33800-S8	Nut (inner to outer arm bolt)	4
33802-S8	Nut (arms to bar bolt)	4
33846-S8	Nut (arm to frame)	6
34846-S2	Lockwasher (bumper arm support to side sill)	4
34847-S8	Lockwasher (inner to outer arm)	4
34808-S8	Lockwasher (arms to bar bolt)	4

1938-39

STATION WAGON-STANDARD

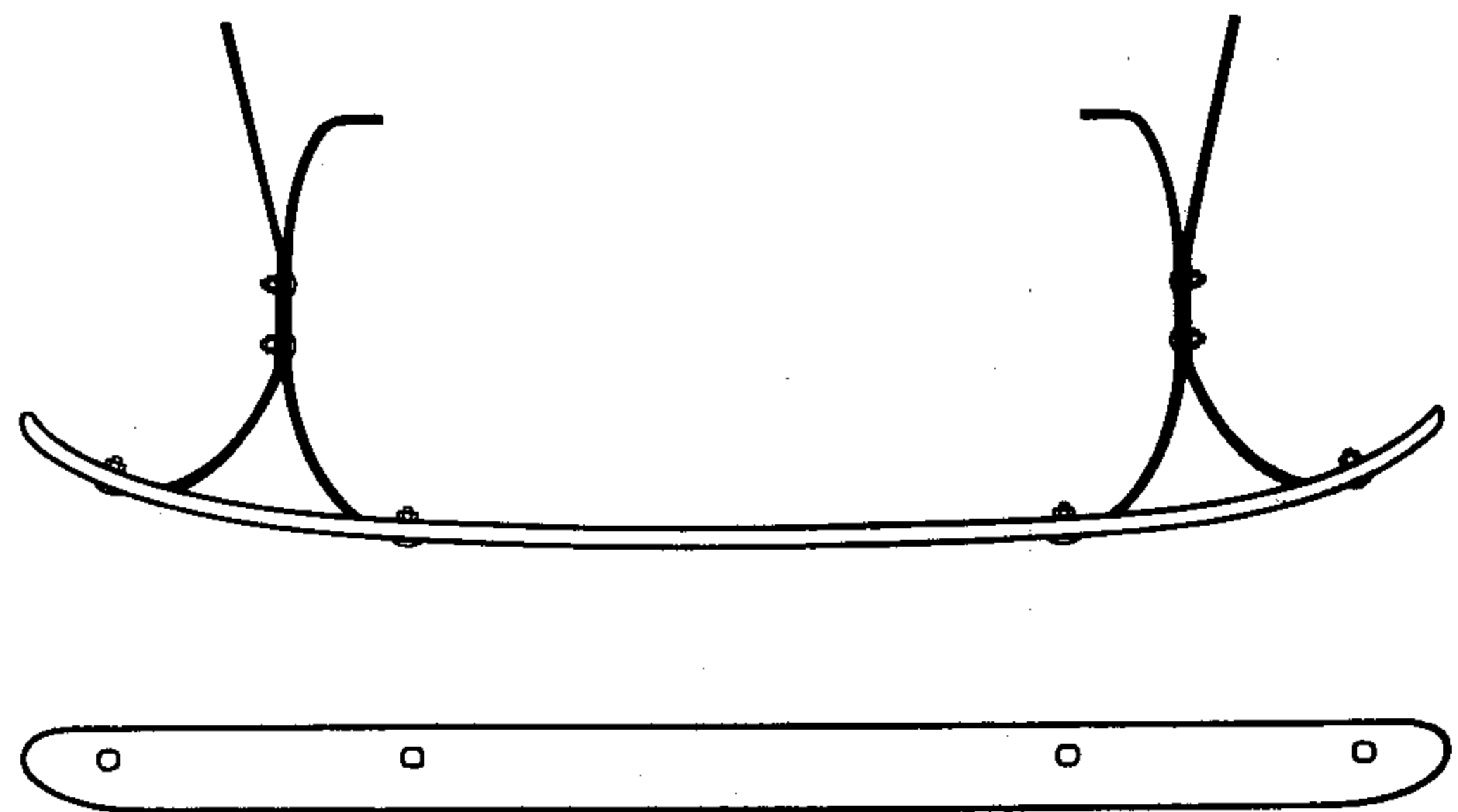

P-269

74 17757	Bar-repl. by 01A 17757-D	1
BB 17758	Bolt (outer arms to bar)	2
01A 17787-C	Arm (inner)-RH	1
01A 17788-C	Arm (inner)-LH	1
91A 17795-B	Arm (outer)-RH	1
+91A 17796-B	Arm (outer)-LH	1
11A 17758	Bolt (arms to bar)	4
+20472-S	Bolt (rear bumper arms to frame)	6
23411-S2	Bolt (inner to outer arm)	4
33800-S8	Nut (inner to outer arm bolt)	4
33802-S8	Nut (arms to bar bolt)	4
33845-S8	Nut (rear arms to frame bolt)	6
33847-S7	Nut (outer arm to bar bolt)	2
44736-S8	Washer (inner arm to frame to cross member bolt)	2
34847-S8	Lockwasher (inner to outer arm bolt)	4
34808-S8	Lockwasher (arms to bar bolt)	4
34849-S2	Lockwasher (rear bumper arms to frame bolt)	6

CHASSIS PARTS CATALOGUE

PART NUMBER	PART NAME	NO. REQ'D	PART NUMBER	PART NAME	NO. REQ'D
-------------	-----------	-----------	-------------	-----------	-----------

Rear Bumper

1938-39

DELUXE TUDOR & FORDOR 1938 (PASSENGER-STANDARD EXCEPT SEDAN DELIVERY & STATION WAGON 1939)

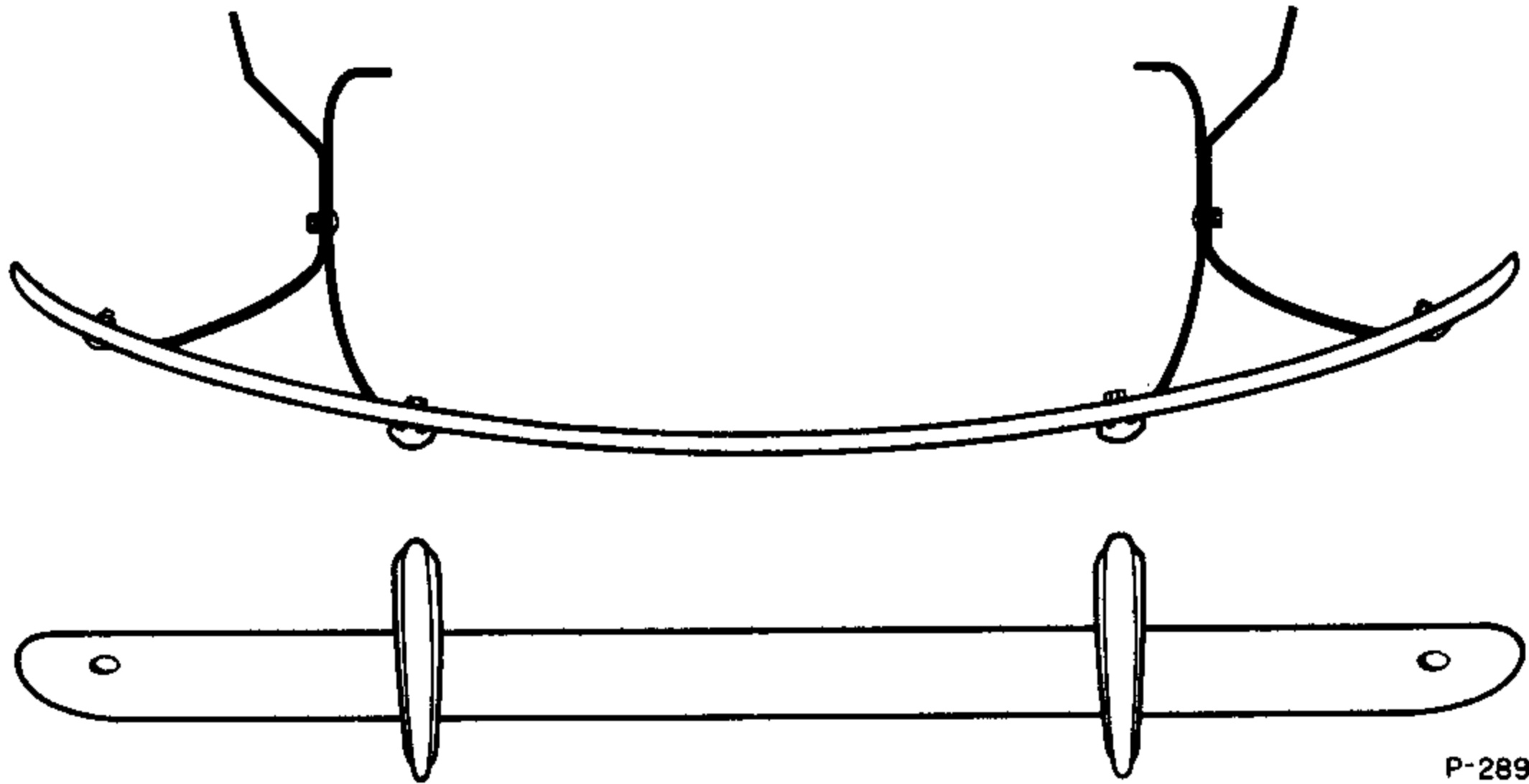

P-289

1939

PASSENGER DELUXE EXCEPT STATION WAGON

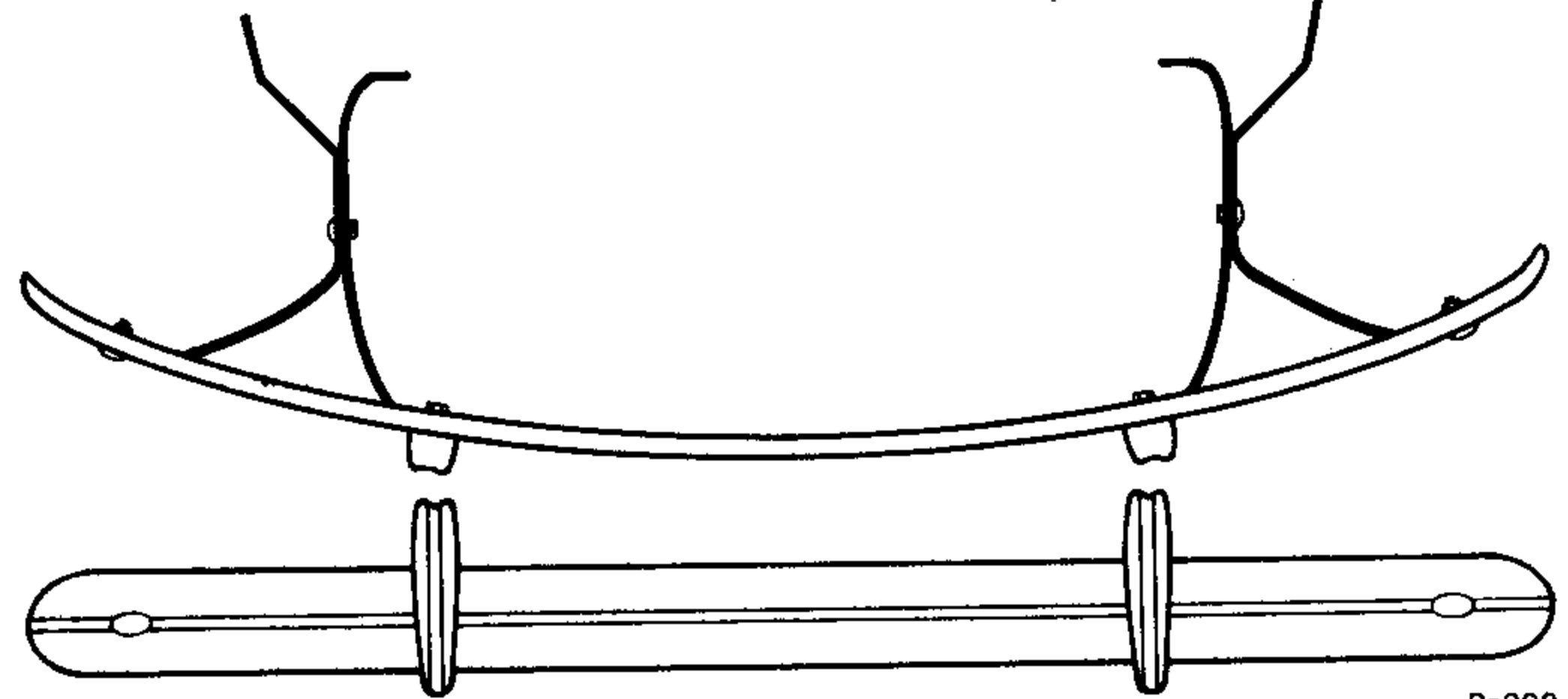

P-292

01A 17757-C	Bar	1
91A 17787-A	Arm (inner)	2
91A 17795-A	Arm (outer)	2
11A 17758	Bolt (outer arm to bar)	2
81A 17996-B	Guard (bumper)	2
†20472-S	Bolt (arms to frame)	6
24453-S8	Bolt (inner arm to bar)	2
23411-S2	Bolt (inner to outer arm)	2
33800-S8	Nut (Inner to outer arm bolt)	2
33802-S8	Nut (outer arm to bar bolt)	2
33845-S8	Nut (rear arms to frame bolt)	6
44736-S8	Washer (inner arm to frame)	2
34847-S8	Lockwasher (inner to outer arm)	2
34849-S2	Lockwasher (inner arm to bar)	2
34849-S2	Lockwasher (arms to frame)	6

01A 17757-C	Bar	1
11A 17758	Bolt (outer arm to bar)	2
91A 17787-A	Arm (inner)	2
91A 17795-A	Arm (outer)	2
91A 17996	Guard (bumper)	2
†20472-S	Bolt (arm to frame)	4
†20472-S	Bolt (inner arm to frame)	2
24453-S8	Bolt (inner arm to bar)	2
23381-S2	Bolt (inner to outer arm)	2
33802-S8	Nut (outer arm to bar bolt)	2
33845-S8	Nut (arms to frame bolt)	6
44736-S8	Washer (inner arm to frame)	2
34808-S8	Lockwasher (outer arm to bar bolt)	2
34849-S2	Lockwasher (arms to frame bolt)	6
34849-S2	Lockwasher (inner arm to bar bolt)	2
34370-S8	Nut (inner to outer arm bolt)	2

1938-41

COMMERCIAL 1938 (BODY TYPES 830, 900, 905) 122" TRUCK EXCEPT PANEL 1938-41

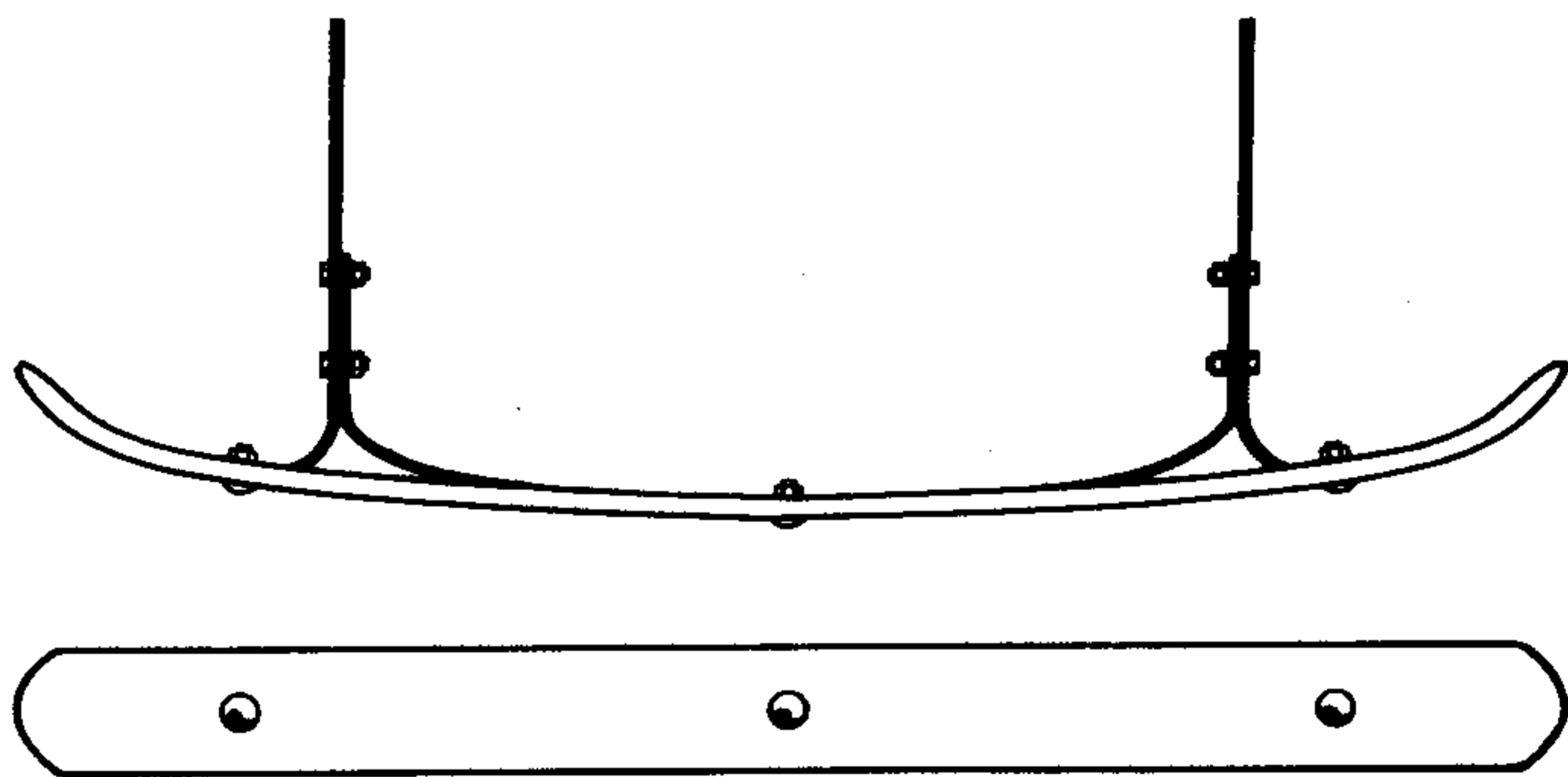

P-295

1939

STATION WAGON-DELUXE

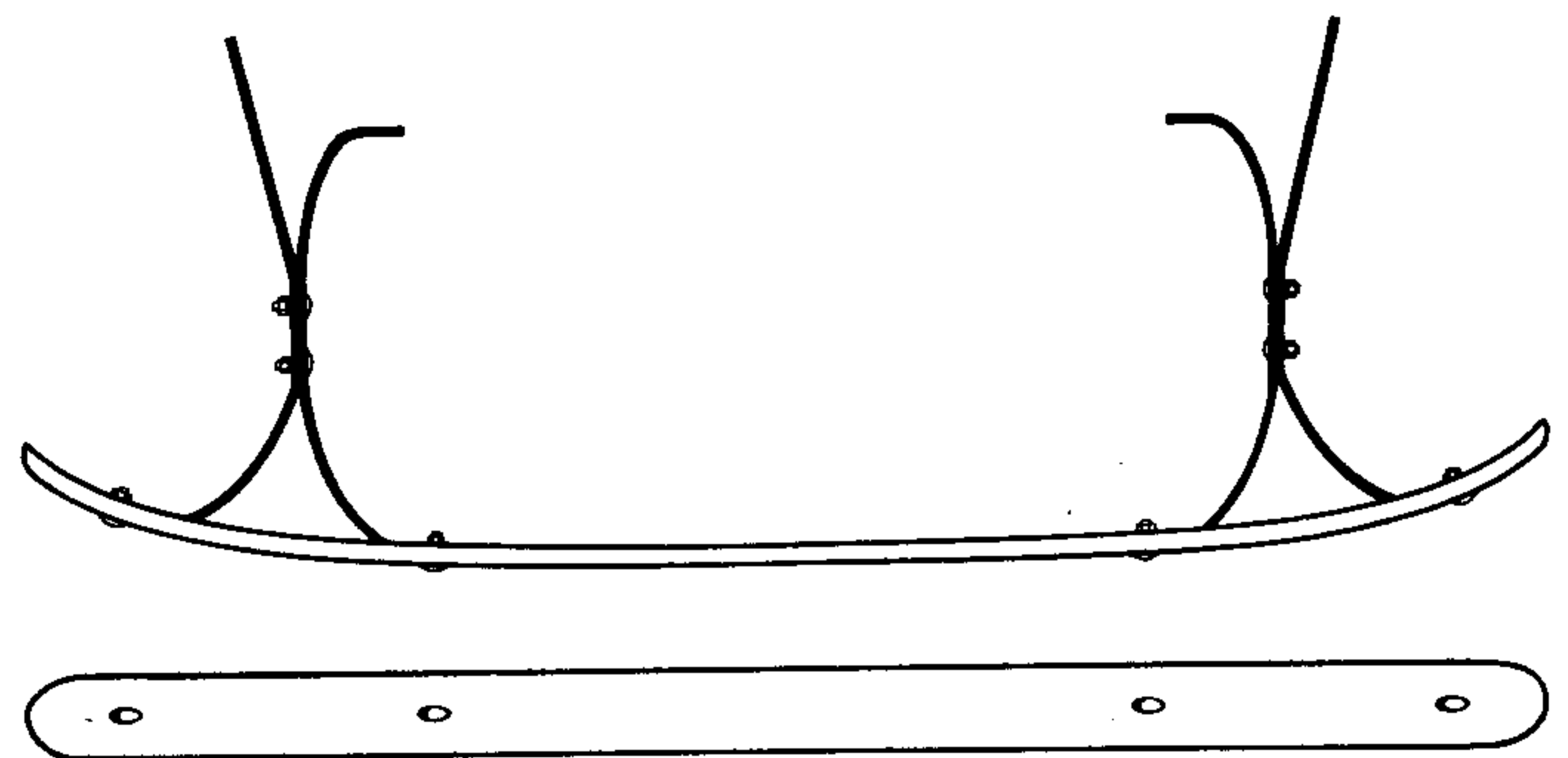

P-263

21T 17906	Bar (chrome)	1
81Y 17955	Arm (outer)-RH	1
81Y 17956	Arm (outer)-LH	1
BB 17758	Bolt (bar to arms)	3
81Y 17957	Reinforcement (arm)	1
†20472-S	Bolt (reinforcement to arm)	4
†20472-S	Bolt (arm to frame)	4
33845-S8	Nut (reinforcement to arm bolt)	4
33845-S8	Nut (arm to frame bolt)	4
34810-S7	Lockwasher (bar to arm & reinf. bolt)	3
33847-S7	Nut (bar to arms)	3
34849-S2	Lockwasher (arm to frame bolt)	4
34849-S2	Lockwasher (reinforcement to arm)	4

91A 17757-B	Bar-repl. by 01A 17787-C	1
11A 17758	Bolt (arms to bar)	4
01A 17787-C	Arm (inner)-RH	1
01A 17788-C	Arm (inner)-LH	1
91A 17795-B	Arm (outer)-RH	1
†91A 17796-B	Arm (outer)-LH	1
†20472-S	Bolt (arm to frame)	4
†20472-S	Bolt (inner arm to frame)	2
23411-S2	Bolt (inner to outer arm)	4
33800-S8	Nut (inner to outer arm bolt)	4
33802-S8	Nut (arms to bar bolt)	4
33845-S8	Nut (arm to frame bolt,	6
34808-S8	Lockwasher (arm to bar bolt)	4
34849-S2	Lockwasher (arm to frame bolt)	6

† No Longer Supplied

CHASSIS PARTS CATALOGUE

PART NUMBER	PART NAME	NO. REQ'D	PART NUMBER	PART NAME	NO. REQ'D
-------------	-----------	-----------	-------------	-----------	-----------

Rear Bumper

1939-41

TRUCK WITH PANEL BODY

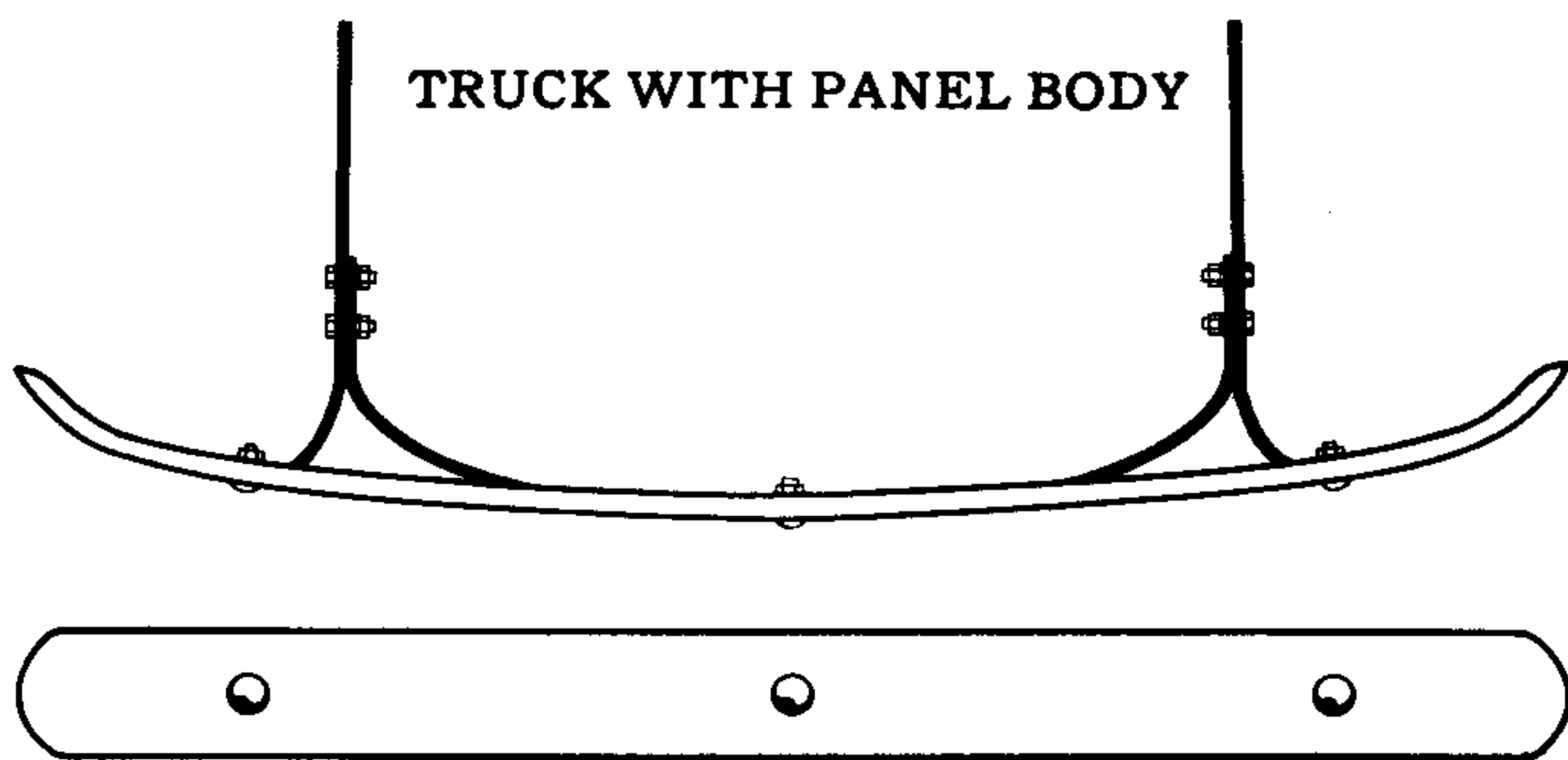

P-284

21T 17906	Bar-chrome	1
81T 17955	Arm (outer)-RH	1
81T 17956	Arm (outer)-LH	1
81T 17957	Reinforcement (bar and arm)	1
BB 17758	Bolt (outer arm to bar)	2
+20472-S	Bolt (arm to frame)	4
+20472-S	Bolt (reinforcement to arm)	4
33845-S8	Nut (reinforcement to arm bolt)	4
33845-S8	Nut (arm to frame bolt)	4
33847-S7	Nut (outer arm to bar bolt)	2
33847-S7	Nut (reinforcement to bar bolt)	1
34810-S7	Lockwasher (reinforcement to bar)	1
34810-S7	Lockwasher (outer arm to bar bolt)	2
34849-S2	Lockwasher (arm to frame bolt)	4
34849-S2	Lockwasher (reinforcement to arm)	4
355743-S2	Bolt (reinforcement to bar)	1

1940

STATION WAGON

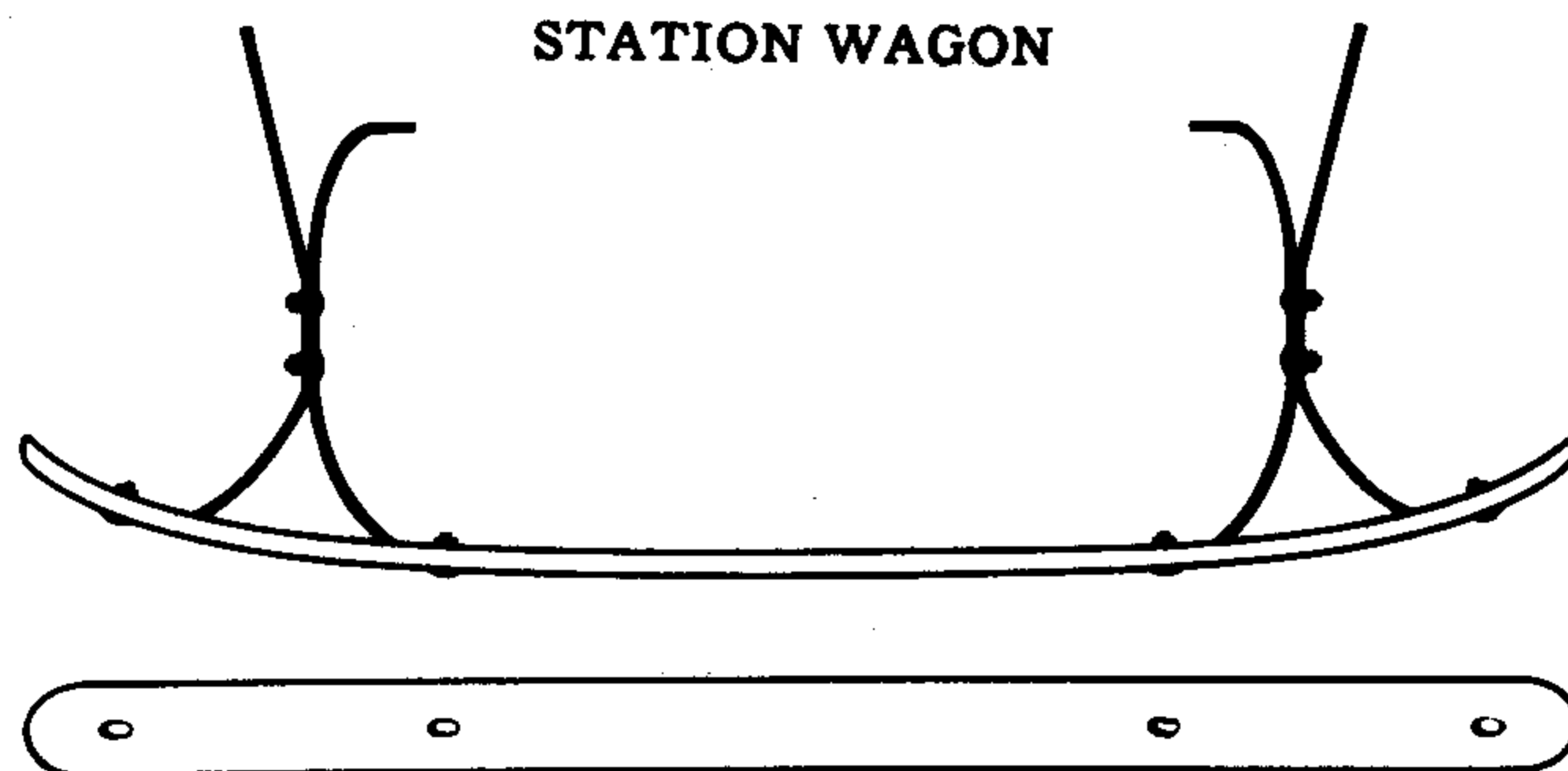

P-262

01A 17757-B	Bar-chrome	1
11A 17758	Bolt (arms to bar)	4
01A 17787-C	Arm (inner)-RH	1
01A 17788-C	Arm (inner)-LH	1
01A 17795-B	Arm (outer)-RH	1
01A 17796-B	Arm (outer)-LH	1
+20472-S	Bolt (arm to frame)	6
23411-S2	Bolt (inner to outer arm)	4
33800-S8	Nut (inner to outer arm bolt)	4
33802-S8	Nut (arms to bar bolt)	4
33845-S8	Nut (arms to frame bolt)	6
44736-S8	Washer (inner arm to frame)	2
34847-S8	Lockwasher (inner to outer arm)	4
34808-S8	Lockwasher (arms to bar bolt)	4
34849-S2	Lockwasher (arm to frame bolt)	6

1940

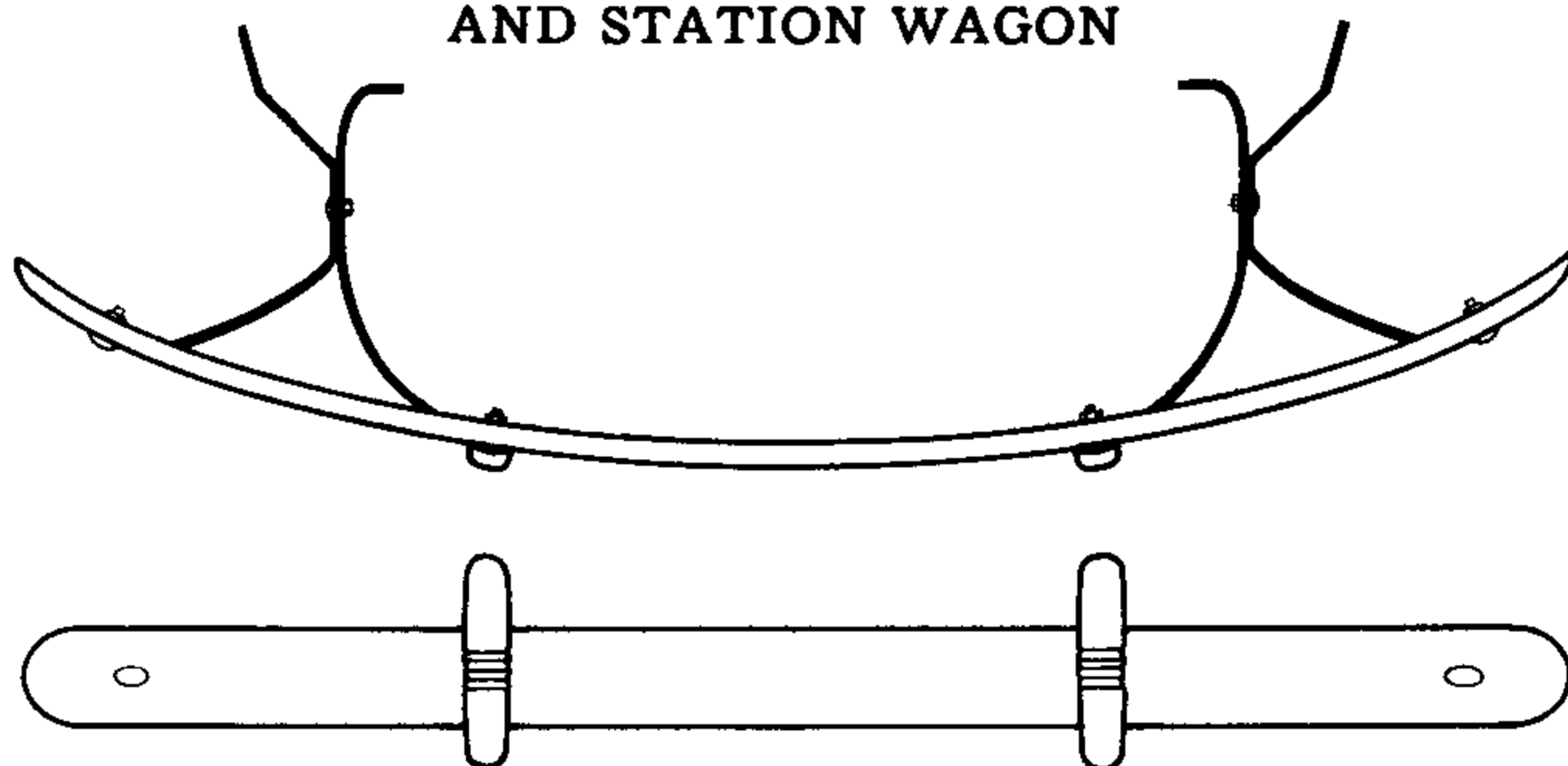
PASSENGER EXCEPT SEDAN DELIVERY
AND STATION WAGON

P-271

01A 17757-A	Bar	1
11A 17758	Bolt (outer arm to bar)	2
01A 17787-A	Arm (inner)	2
91A 17795-A	Arm (outer)	2
01A 17996	Guard (bumper)	2
+20472-S	Bolt (arms to frame)	6
23381-S2	Bolt (inner to outer arm)	2
20423-S2	Bolt (inner arm to bar to guard)	2
33802-S8	Nut (outer arm to bar bolt)	2
33845-S8	Nut (arms to frame bolt)	6
44736-S8	Washer (inner arm to frame)	2
34808-S8	Lockwasher (outer arm to bar)	2
34849-S2	Lockwasher (arms to frame bolt)	6
34849-S2	Lockwasher (inner arm to bar)	2
34370-S8	Nut (inner to outer arm bolt)	2

1940-41

SEDAN DELIVERY

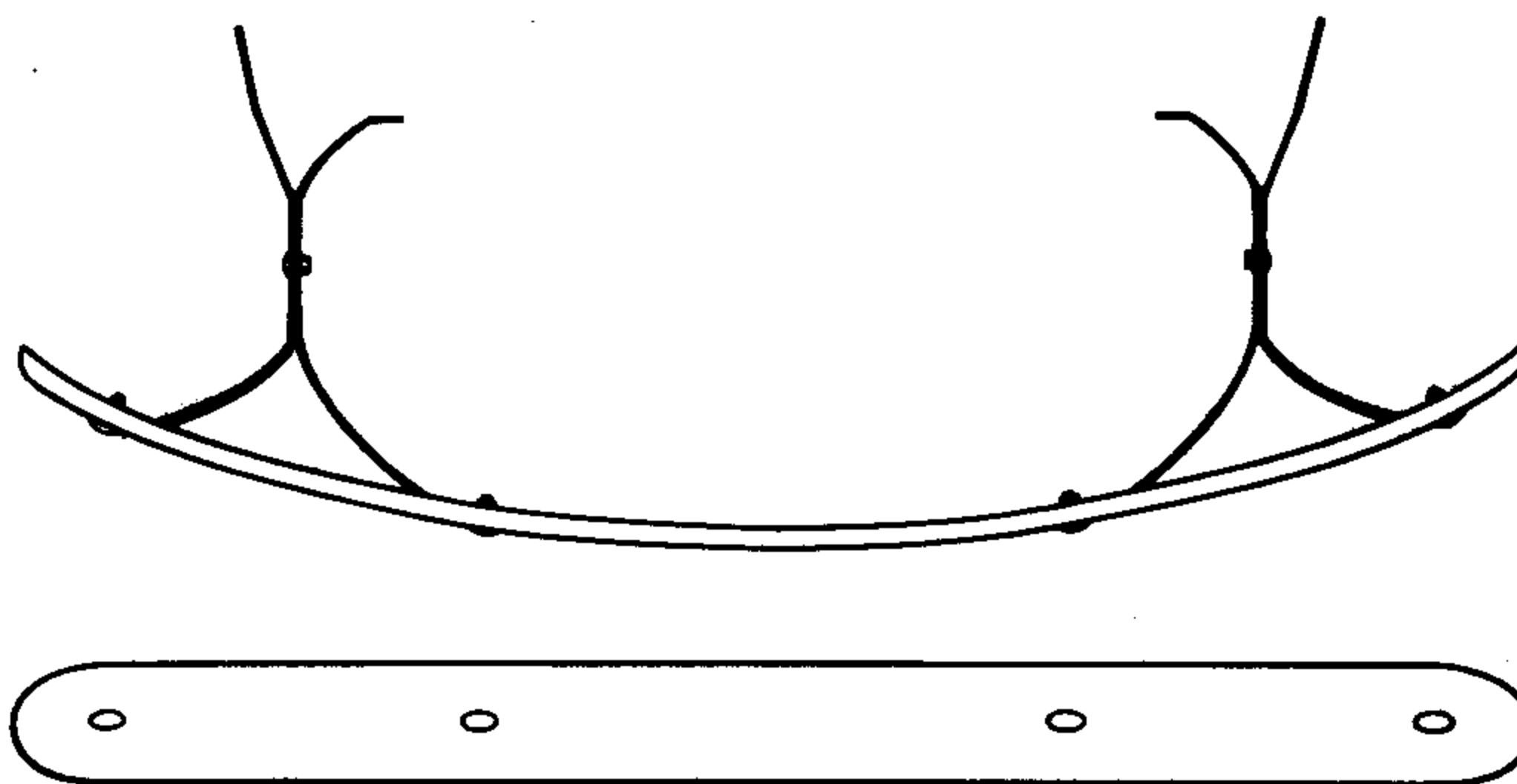

P-268

01A 17757-A	Bar-chrome	1
+01A 17787-B	Arm (inner)-RH	1
01A 17788-B	Arm (inner)-LH	1
01A 17795-A	Arm (outer)-RH	1
01A 17796-A	Arm (outer)-LH	1
11A 17758	Bolt (arms to bar)	4
+20472-S	Bolt (arm to frame)	6
23381-S2	Bolt (inner to outer arm)	2
33802-S8	Nut (arms to bar bolt)	4
44736-S8	Washer (inner arm to frame)	2
34808-S8	Lockwasher (arms to bar bolt)	4
33845-S8	Nut (arms to frame bolt)	6
34849-S2	Lockwasher (arms to frame bolt)	6
34370-S8	Nut (inner to outer arm bolt)	2

† No Longer Supplied

CHASSIS PARTS CATALOGUE

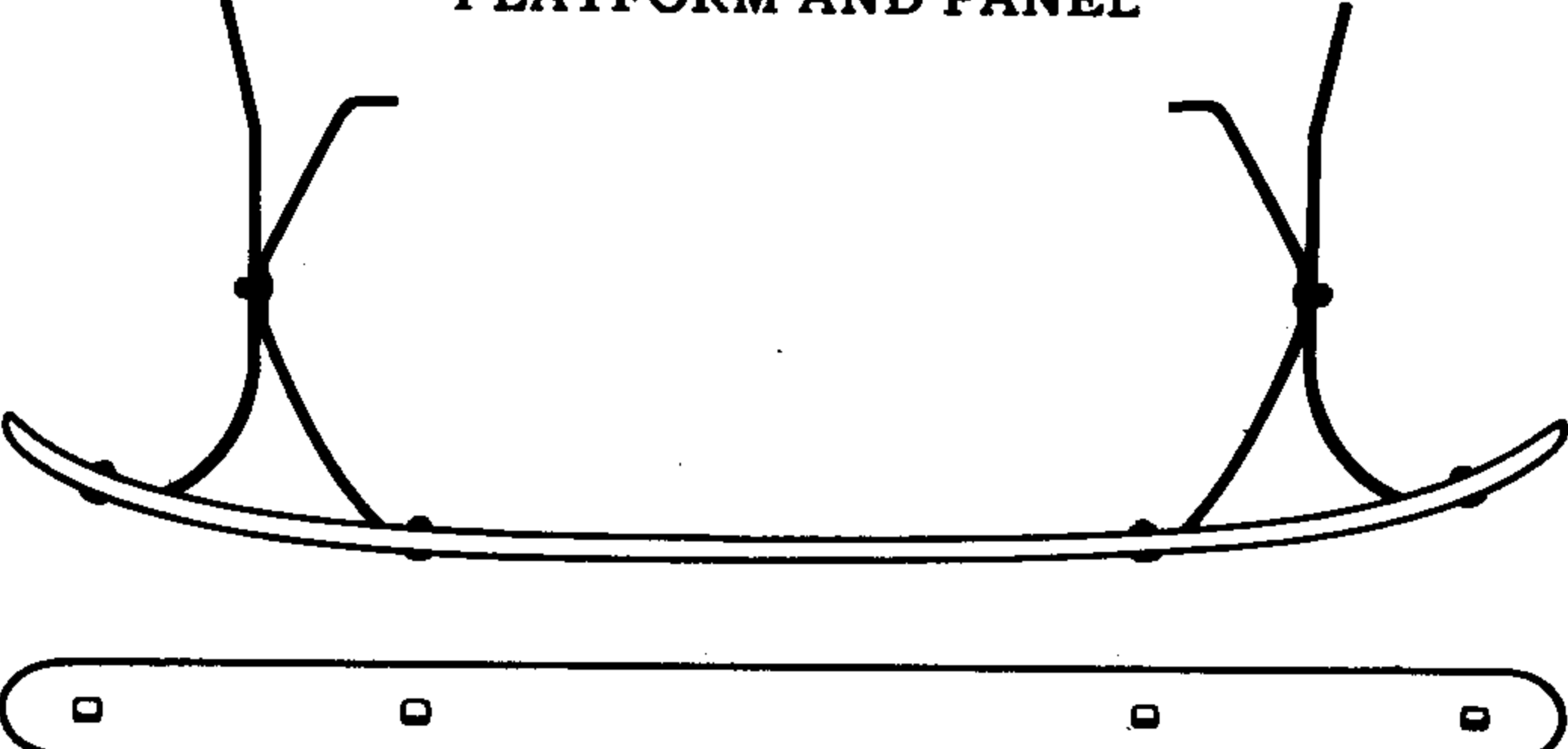
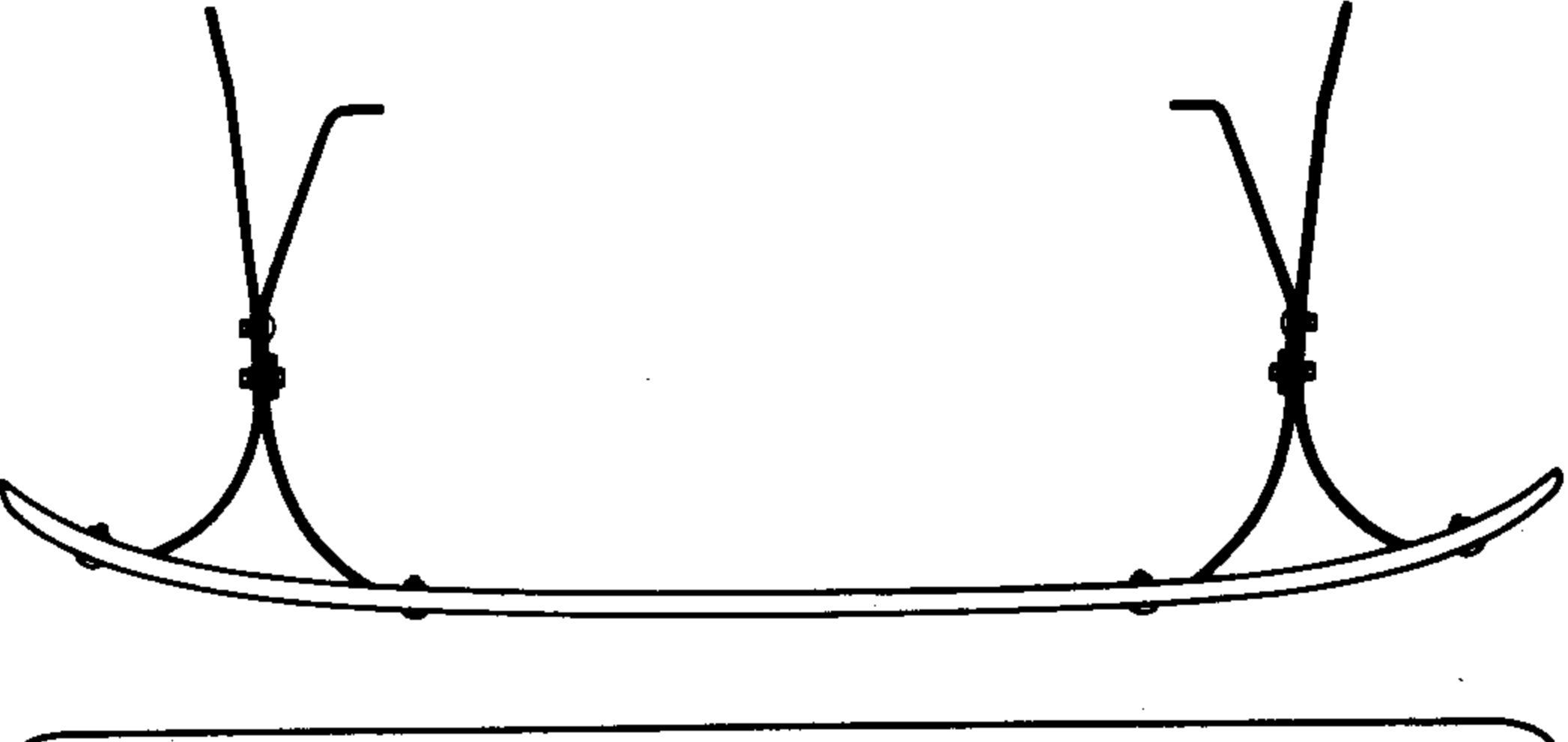
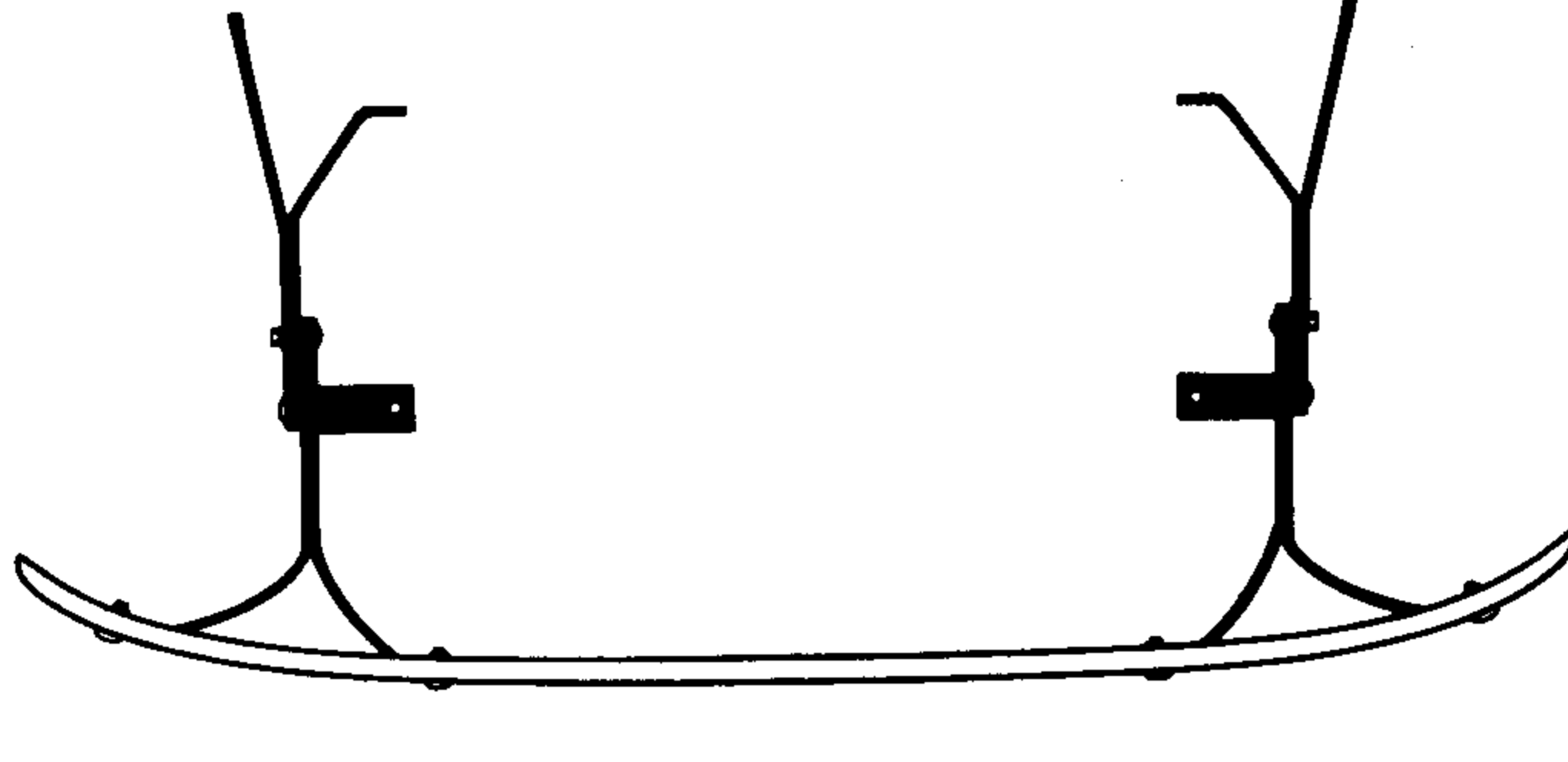
PART NUMBER	PART NAME	NO. REQ'D	PART NUMBER	PART NAME	NO. REQ'D
Rear Bumper					
1940-41					
COMMERCIAL EXCEPT SEDAN DELIVERY, PLATFORM AND PANEL					
					
P-265					
01A 17757-B 01C 17787-A 01C 17788-A 01C 17795-A 01C 17796-A 11A 17758 †20472-S 23428-S2 33802-S8 33802-S8 33845-S8 44736-S8 34808-S8 34808-S8 34849-S2	Bar-chrome Arm (inner)-RH Arm (inner)-LH Arm (outer)-RH Arm (outer)-LH Bolt (arms to bar) Bolt (arm to frame) Bolt (inner to outer arm) Nut (arms to bar bolt) Nut (inner to outer arm bolt) Nut (arms to frame bolt) Washer (inner arm to frame) Lockwasher (arms to bar bolt) Lockwasher (inner to outer arm) Lockwasher (arms to frame bolt)	1 1 1 1 1 4 6 2 4 6 2 4 2 4 6			
1940-41					
COMMERCIAL WITH PLATFORM BODY					
					
P-267					
01A 17757-B 01C 17787-B 01C 17795-B 11A 17758 77 17918-B †20472-S 20449-S2 23411-S2	Bar-chrome Arm (inner) Arm (outer) Bolt (arms to bar) Support (arm) Bolt (arm to frame) Bolt (inner to outer arm) Bolt (inner to outer arm)	1 2 2 4 1 6 2 2			
			1940-41		
			PANEL DELIVERY		
					
			P-294		
01A 17757-B 01C 17787-C 01C 17795-C 81C 17925 81C 17926 81C 17958 †81C 17959 11A 17758 81C 17918 †20472-S 24493-S7 33800-S8 33802-S8 33845-S8 34808-S8 34847-S8 34849-S2	Bar-chrome Arm (inner) Arm (outer) Hanger (inner frame)-RH Hanger (inner frame)-LH Hanger (outer frame)-RH Hanger (outer frame)-LH Bolt (arms to bar) Support (arm) Bolt (arm to frame) Bolt (inner to outer arm) Nut (inner to outer arm) Nut (arms to bar bolt) Nut (arm to frame bolt) Lockwasher (arms to bar bolt) Lockwasher (inner to outer arm) Lockwasher (arm to frame bolt)	1 2 2 1 1 1 1 1 4 2 6 4 4 6 4 4 6			

† No Longer Supplied

PART NUMBER	PART NAME	NO. REQ'D	PART NUMBER	PART NAME	NO. REQ'D
-------------	-----------	-----------	-------------	-----------	-----------

Rear Bumper

1941

PASSENGER-SUPER DELUXE EXCEPT STATION WAGON

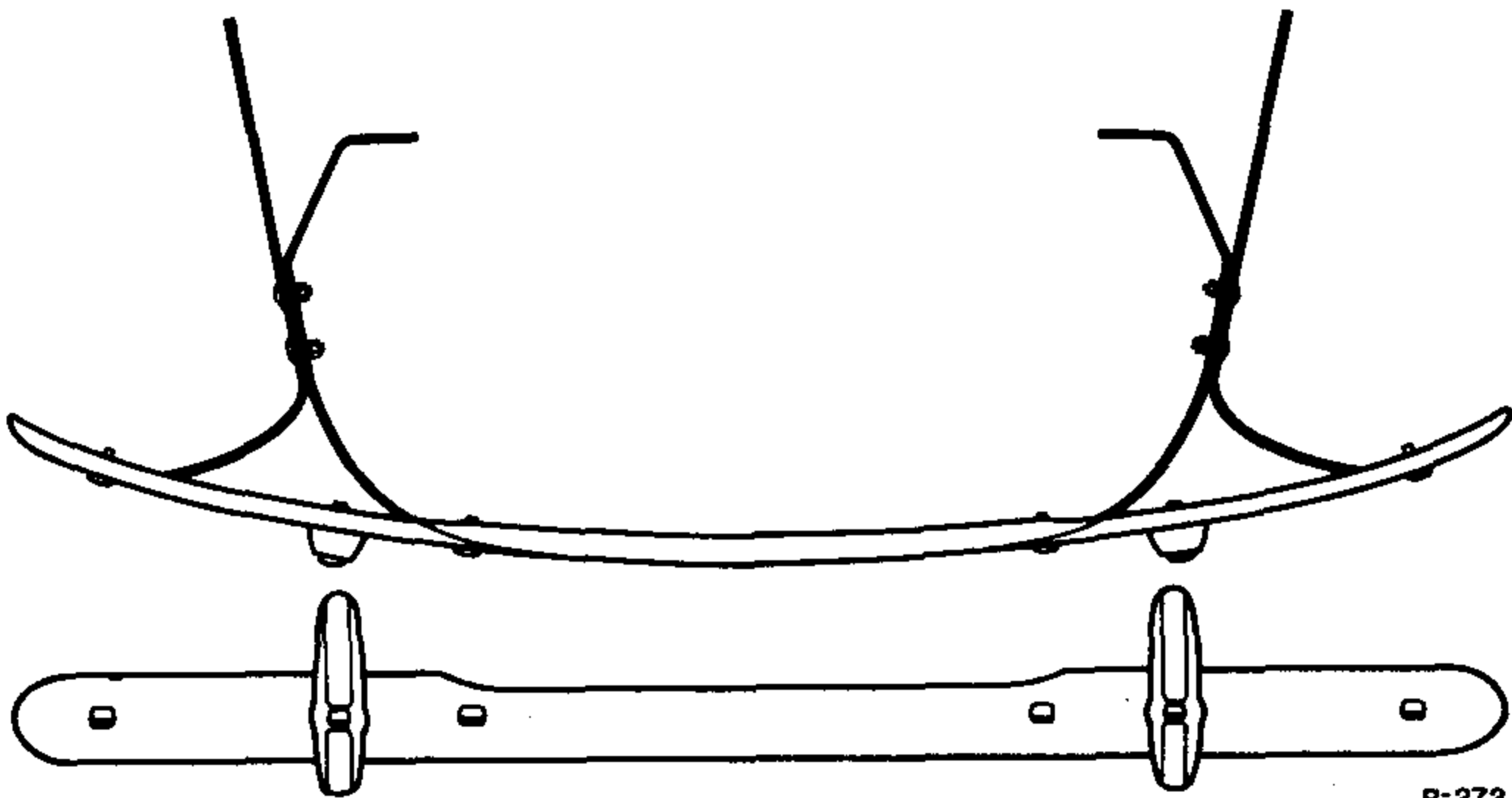

11A 17757-A	Bar	1
11A 17787-B	Arm (inner)-RH	1
11A 17788-B	Arm (inner)-LH	1
11A 17795-B	Arm (outer)-RH	1
11A 17796-B	Arm (outer)-LH	1
11A 17758	Bolt (arms to bar)	4
11A 17908	Bolt (guard to bar)	2
11A 17996-A	Guard (bumper)	2
+20472-S	Bolt (arm to frame)	6
350667-S2	Bolt (inner to outer arm)	4
33800-S8	Nut (inner to outer arm bolt)	4
33802-S8	Nut (arms to bar bolt)	4
33845-S8	Nut (arm to frame bolt)	6
44736-S8	Washer (inner arm to frame)	2
34808-S8	Lockwasher (inner to outer arm)	4
33845-S8	Nut (guard to bar bolt)	2
34849-S2	Lockwasher	12

1941

PASSENGER-SUPER DELUXE EXCEPT STATION WAGON

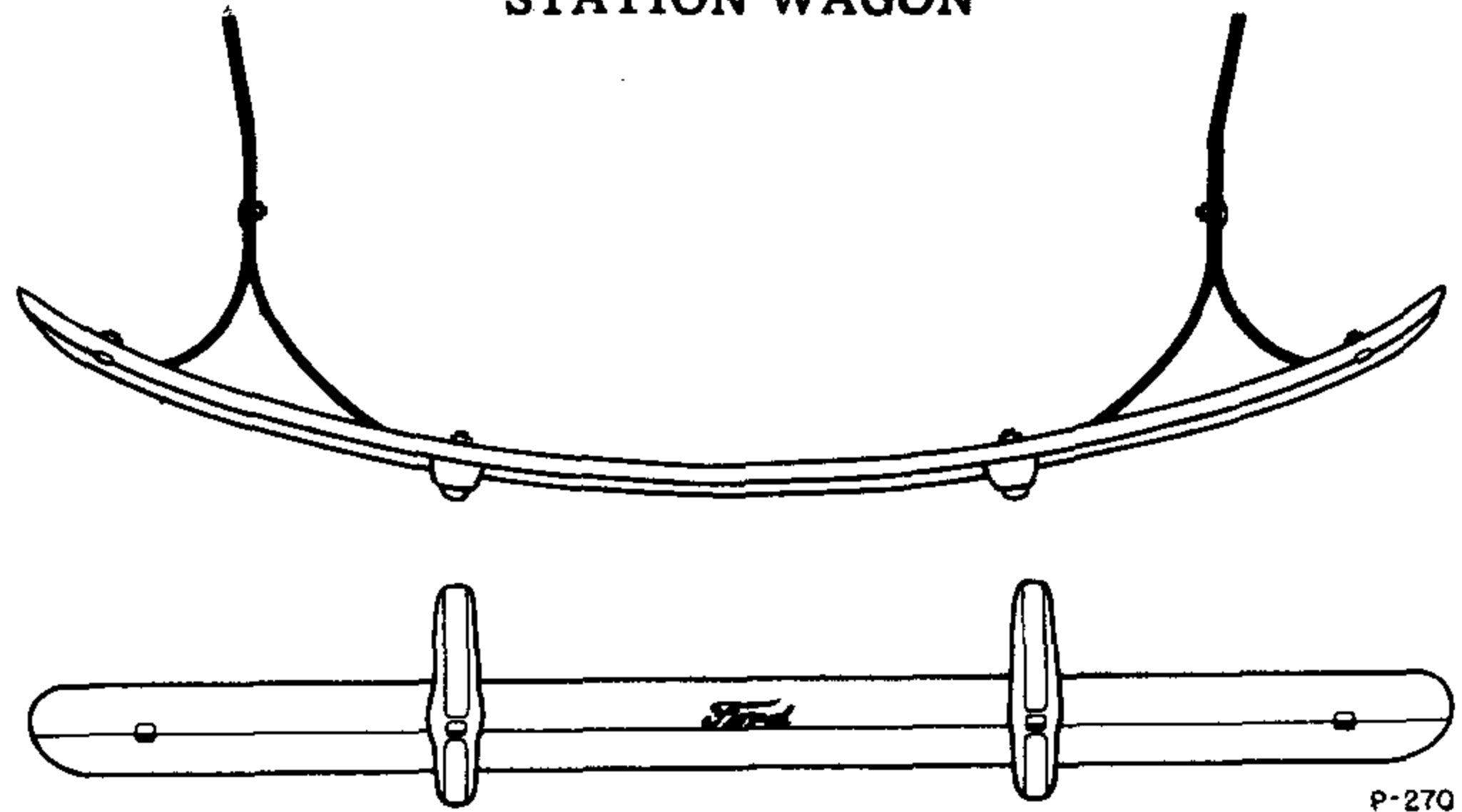

21A 17781-B	Bar	1
11A 17787-A	Arm (inner)	2
11A 17795-A	Arm (outer)	2
11A 17908	Bolt (inner arm to bar)	2
11A 17758	Bolt (outer arm to bar)	2
11A 17996-B	Guard (bumper)	2
+20472-S	Bolt (arms to frame)	4
23381-S2	Bolt (inner to outer arm)	2
33802-S8	Nut (outer arm to bar)	2
33845-S8	Nut (arms to frame bolt)	4
33846-S8	Nut (inner arm to bar bolt)	2
34849-S2	Lockwasher	6
34370-S8	Nut (inner to outer arm bolt)	2

1941

SEDAN DELIVERY

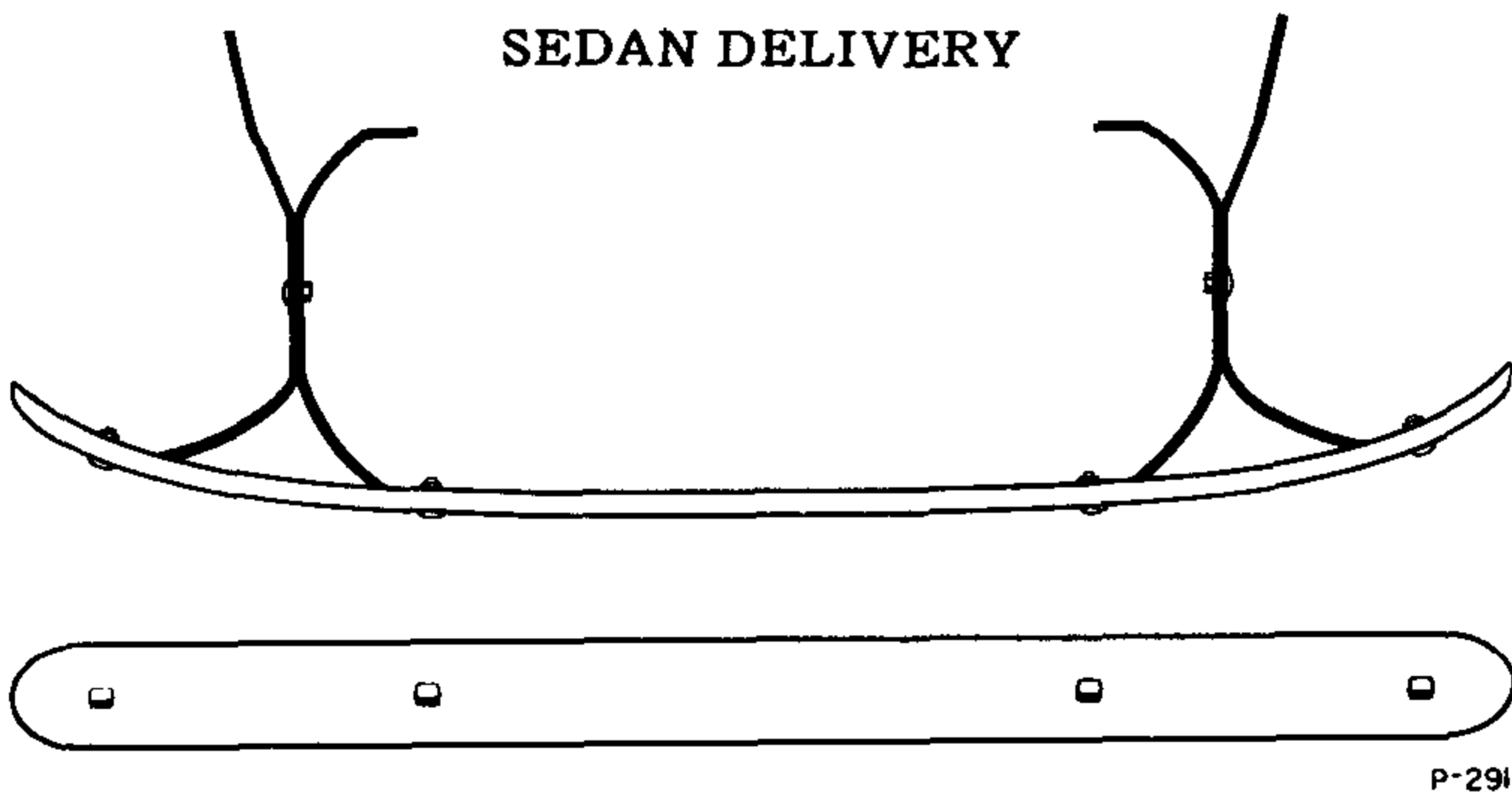

01A 17757-B	Bar	1
11C 17787-A	Arm (inner)-RH	1
11C 17788-A	Arm (inner)-LH	1
11C 17795-A	Arm (outer)-RH	1
11C 17796-A	Arm (outer)-LH	1
11A 17758	Bolt (arms to bar)	4
+20472-S	Bolt (arm to frame)	6
23381-S2	Bolt (inner to outer arm)	2
33802-S8	Nut (arms to bar bolt)	4
33845-S8	Nut (arm to frame bolt)	6
44736-S8	Washer (inner arm to frame)	2
34808-S8	Lockwasher (arms to bar bolt)	4
34849-S2	Lockwasher (arm to frame bolt)	4
34370-S8	Nut (inner to outer arm bolt)	2

1941

PASSENGER EXCEPT SUPER DELUXE AND STATION WAGON

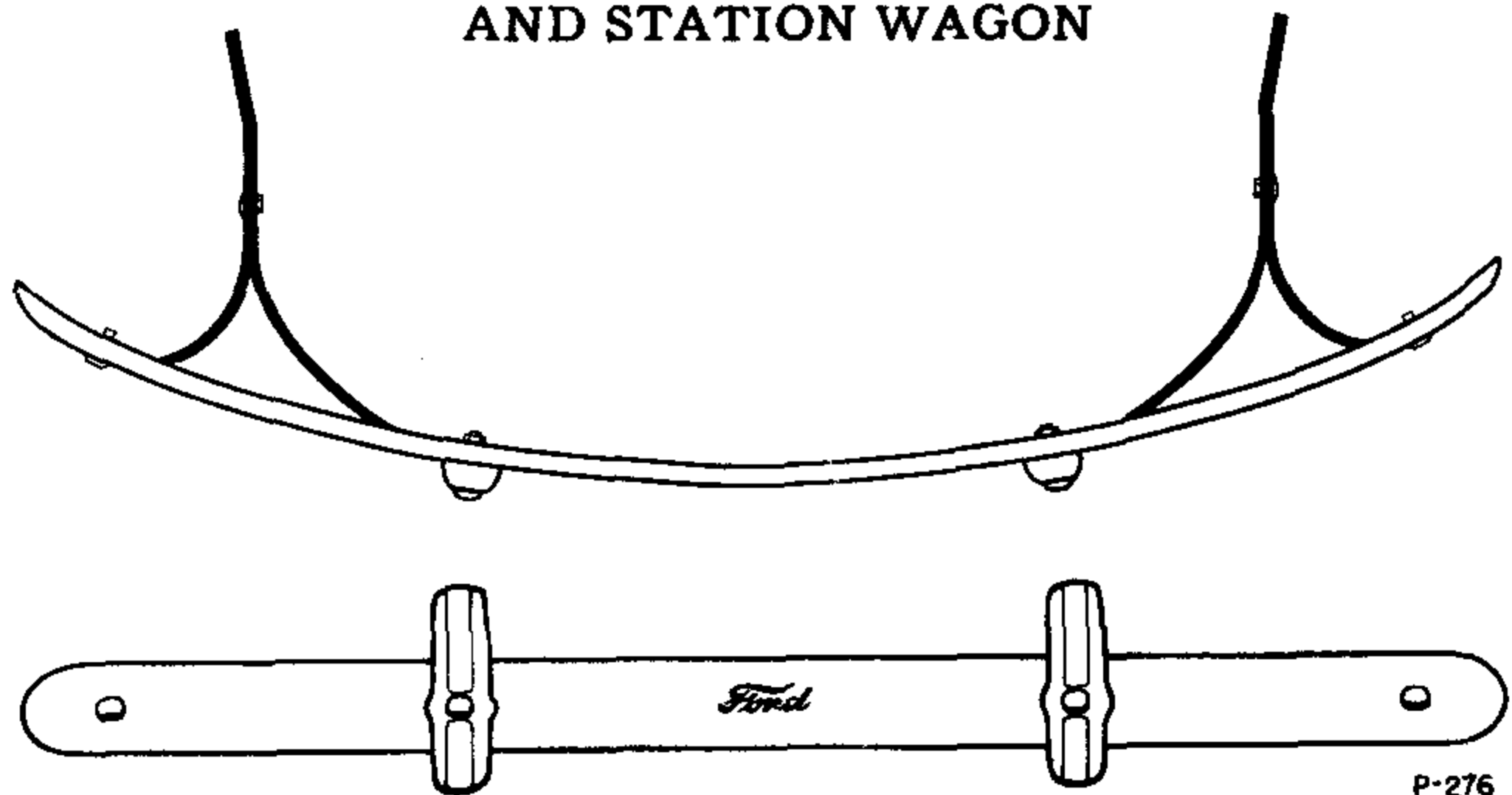

01A 17757-A	Bar	1
11A 17787-C	Arm (inner)-offset design-RH	1
11A 17788-C	Arm (inner)-offset design-LH	1
11A 17795-C	Arm (outer)-offset design-RH	1
11A 17796-C	Arm (outer)-offset design-LH	1
11A 17758	Bolt (arms to bar)	2
11A 17908	Bolt (guard to bar to inner arm)	2
11A 17996-A	Guard (bumper)	2
+20472-S	Bolt (arms to frame)	4
23381-S2	Bolt (inner to outer arm)	2
33802-S8	Nut (arms to bar bolt)	2
33845-S8	Nut (arms to frame bolt)	4
33846-S8	Nut (guard to bar to inner arm)	2
34808-S8	Lockwasher (arms to bar bolt)	2
34849-S2	Lockwasher	6
34370-S8	Nut (inner to outer arm bolt)	2

+ No Longer Supplied

CHASSIS PARTS CATALOGUE

PART NUMBER	PART NAME	NO. REQ'D	PART NUMBER	PART NAME	NO. REQ'D
-------------	-----------	-----------	-------------	-----------	-----------

Rear Bumper

1941

PASSENGER-SUPER DELUXE EXCEPT STATION WAGON

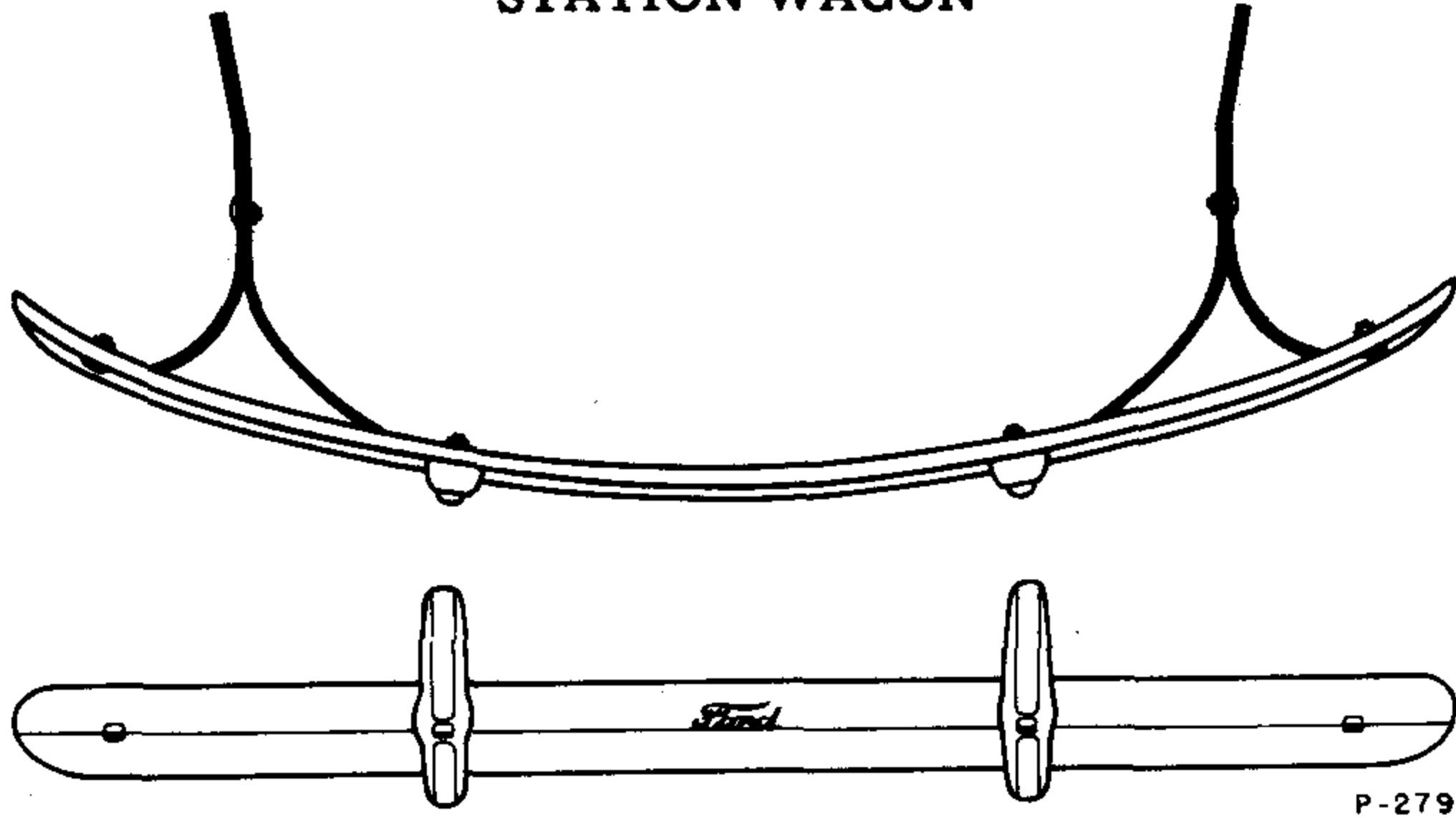

P-279

1941-42

PASSENGER (EXCEPT SUPER DELUXE, SEDAN DELIVERY AND STATION WAGON)

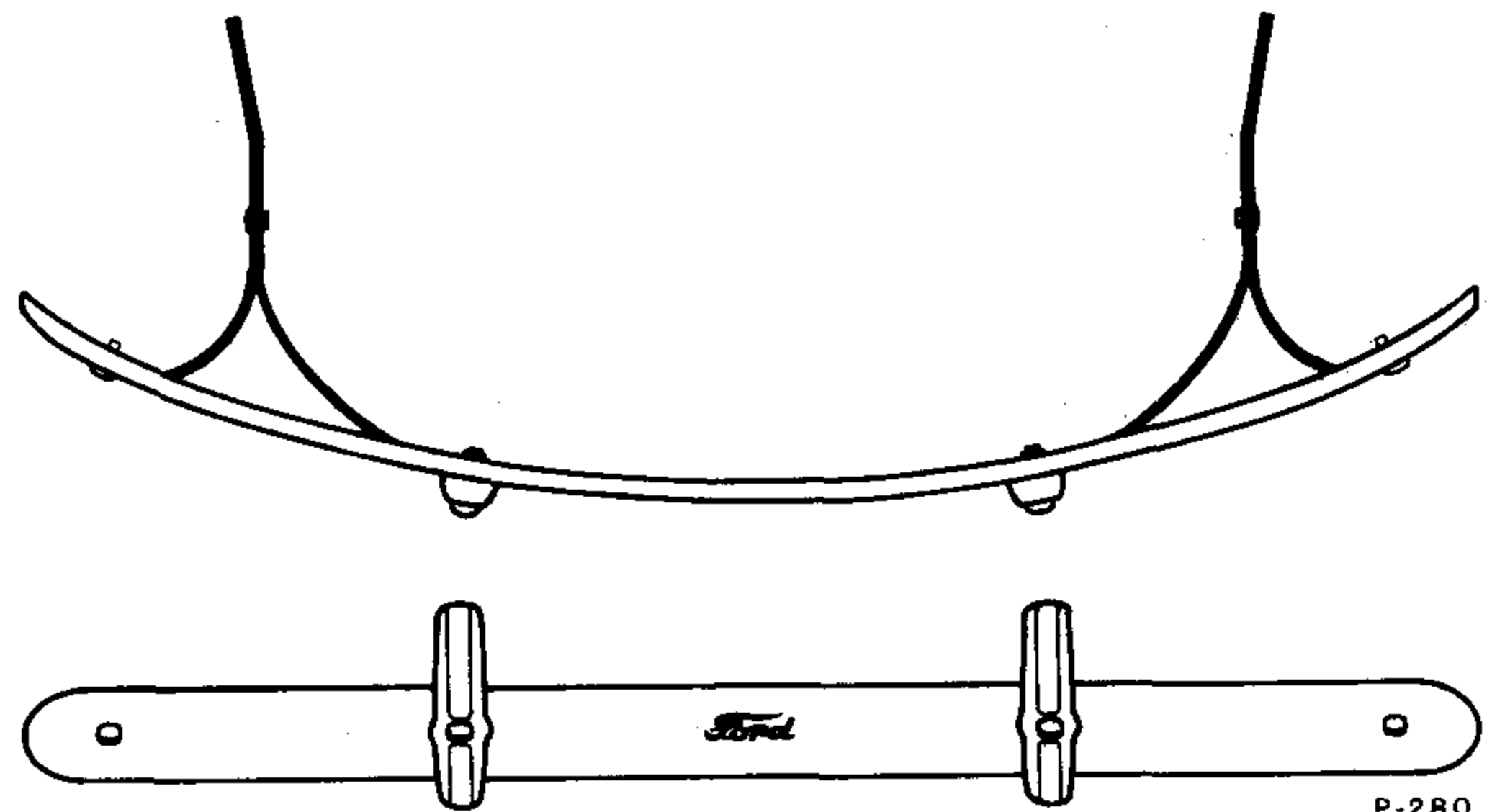

P-280

21A 17781-B	Bar	1
11A 17787-C	Arm (inner)-RH	1
11A 17788-C	Arm (inner)-LH	1
11A 17795-C	Arm (outer)-RH	1
11A 17796-C	Arm (outer)-LH	1
11A 17758	Bolt (arms to bar)	2
11A 17908	Bolt (inner arm to bar)	2
11A 17996-B	Guard (bumper)	2
†20472-S	Bolt (arm to frame)	4
23381-S2	Bolt (inner to outer arm)	2
33802-S8	Nut (outer arm to bar bolt)	2
33845-S8	Nut (arm to frame bolt)	4
33846-S8	Nut (inner arm to bar bolt)	2
34808-S8	Lockwasher (outer arm to bar bolt)	2
34849-S2	Lockwasher	6
34370-S8	Nut (inner to outer arm bolt)	2

01A 17757-A	Bar	1
11A 17787-A	Arm (inner)	2
11A 17795-A	Arm (outer)	2
11A 17908	Bolt (inner arm to bar)	2
11A 17758	Bolt (outer arm to bar)	2
11A 17996-A	Guard (bumper)	2
†20472-S	Bolt (arms to frame)	4
23381-S2	Bolt (inner to outer arm)	2
33802-S8	Nut (outer arm to bar bolt)	2
33845-S8	Nut (arms to frame bolt)	4
33846-S8	Nut (inner arm to bar bolt)	2
34849-S2	Lockwasher	8
34370-S8	Nut (inner to outer arm bolt)	2

1942

PASSENGER (EXCEPT SUPER DELUXE AND SEDAN DELIVERY)

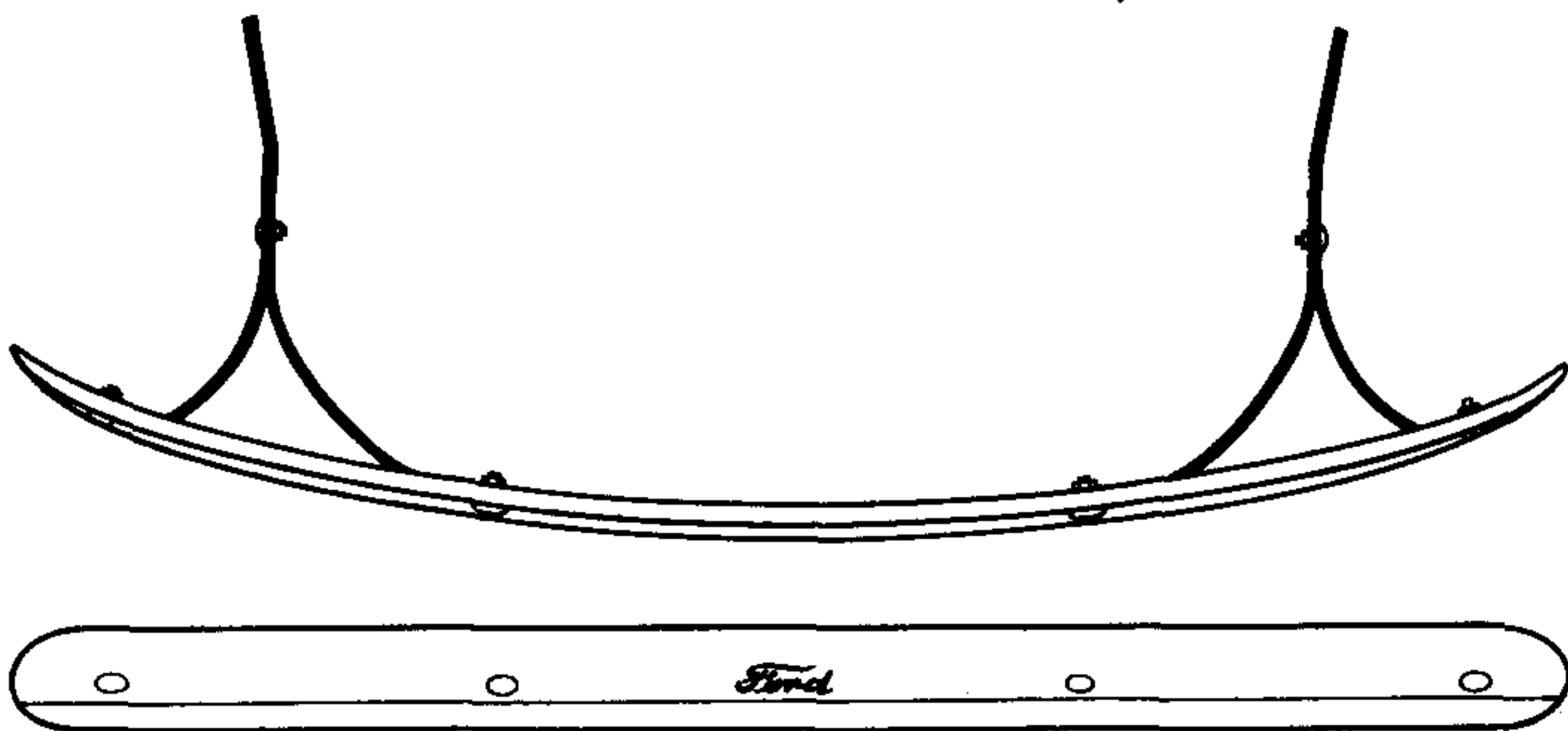

P-273

21A 17781-B	Bar	1
21A 17787-A	Arm (inner)	2
21A 17795-D	Arm (outer)	2
11A 17758	Bolt (arm to bar)	4
†20472-S	Bolt (arm to frame)	4
33802-S8	Nut (arm to bar)	4
33845-S8	Nut (arm to frame bolt)	4
34808-S8	Lockwasher (arm to bar)	4
34849-S2	Lockwasher (arm to frame bolt)	4
23411-S2	Bolt (inner to outer arm)	2
34370-S8	Nut (inner to outer arm)	2

1941-48

STATION WAGON

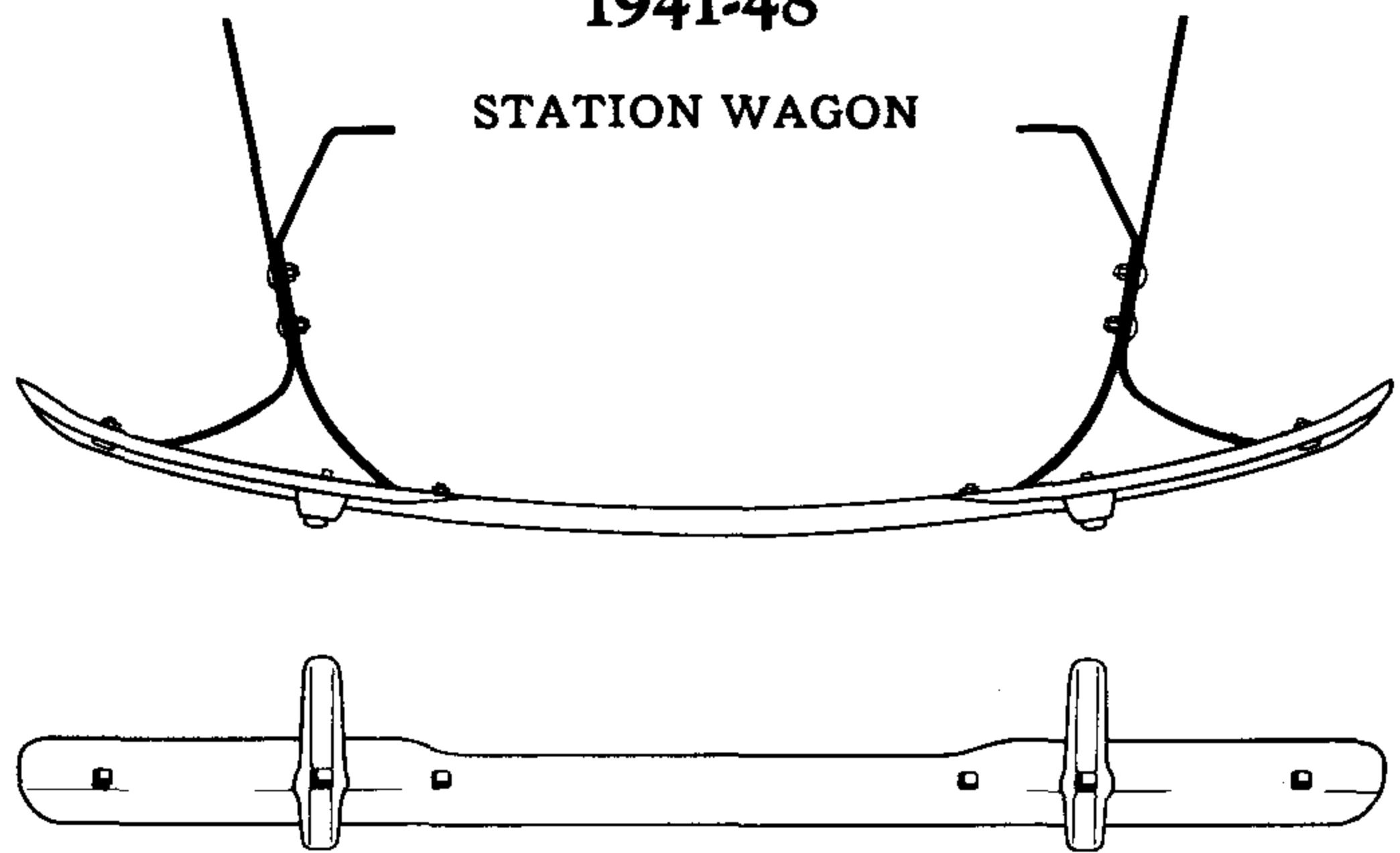

P-260

11A 17781-C	Bar	1
11A 17787-B	Arm (inner)-RH	1
11A 17788-B	Arm (inner)-LH	1
11A 17795-B	Arm (outer)-RH	1
11A 17796-B	Arm (outer)-LH	1
11A 17758	Bolt (arms to bar)	4
†20472-S	Bolt (arm to frame)	4
350667-S2	Bolt (inner to outer arm)	4
33800-S8	Nut (inner to outer arm bolt)	4
33802-S8	Nut (arms to bar bolt)	4
33845-S8	Nut (arm to frame bolt)	4
34847-S8	Lockwasher (inner to outer arm)	4
34849-S2	Lockwasher	8

† No Longer Supplied



CHASSIS PARTS CATALOGUE

PART NUMBER	PART NAME	NO. REQ'D	PART NUMBER	PART NAME	NO. REQ'D
-------------	-----------	-----------	-------------	-----------	-----------

Rear Bumper

1942-47

(PASSENGER-SUPER DELUXE EXCEPT STATION WAGON 1942)
(PASSENGER EXCEPT SEDAN DELIVERY AND STATION WAGON 1946-47)

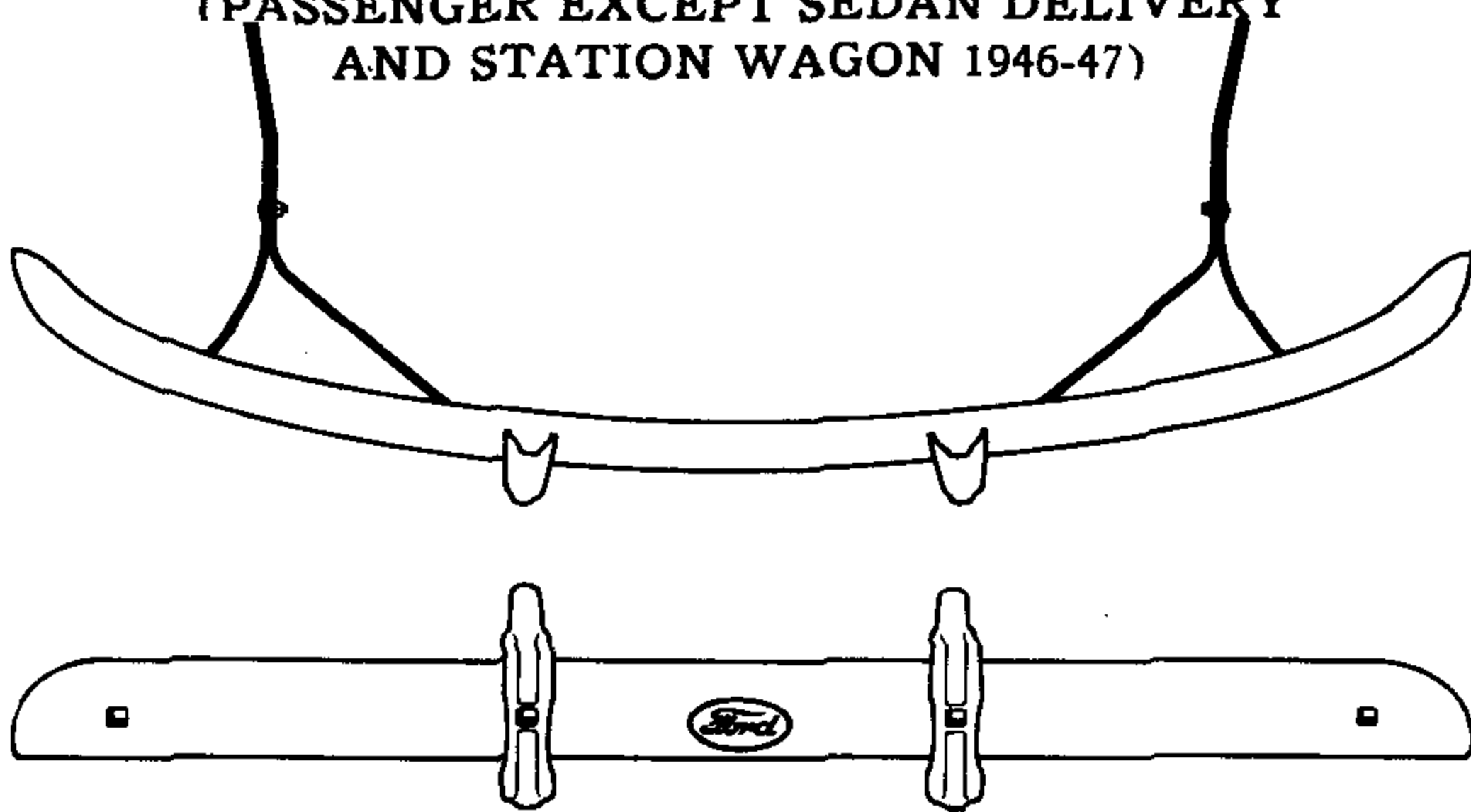

P-283

51A 17781	Bar (impact)	1
21A 17787-A	Arm (inner)-RH	1
21A 17788-A	Arm (inner)-LH	1
21A 17795-A	Arm (outer)-RH	1
21A 17796-A	Arm (outer)-LH	1
11A 17758	Bolt (bar to outer arm)	2
21A 17908	Bolt (guard to bar to inner arm)	2
21A 17984	Guard (bumper)	2
+20472-S	Bolt (arms to frame)	4
23426-S7	Bolt (inner to outer arm)	2
34370-S8	Nut (inner to outer arm bolt)	2
23426-S7	Bolt (inner to outer arm)	2
33845-S8	Nut (arms to frame bolt)	4
33802-S8	Nut (arms to bar bolt)	2
34397-S7	Locknut (bar to outer arm bolt)	2
34399-S8	Locknut (guard to bar to arm)	2
34849-S2	Lockwasher (arm to frame bolt)	4
34370-S8	Nut (inner to outer arm bolt)	2

1942-48

SEDAN DELIVERY

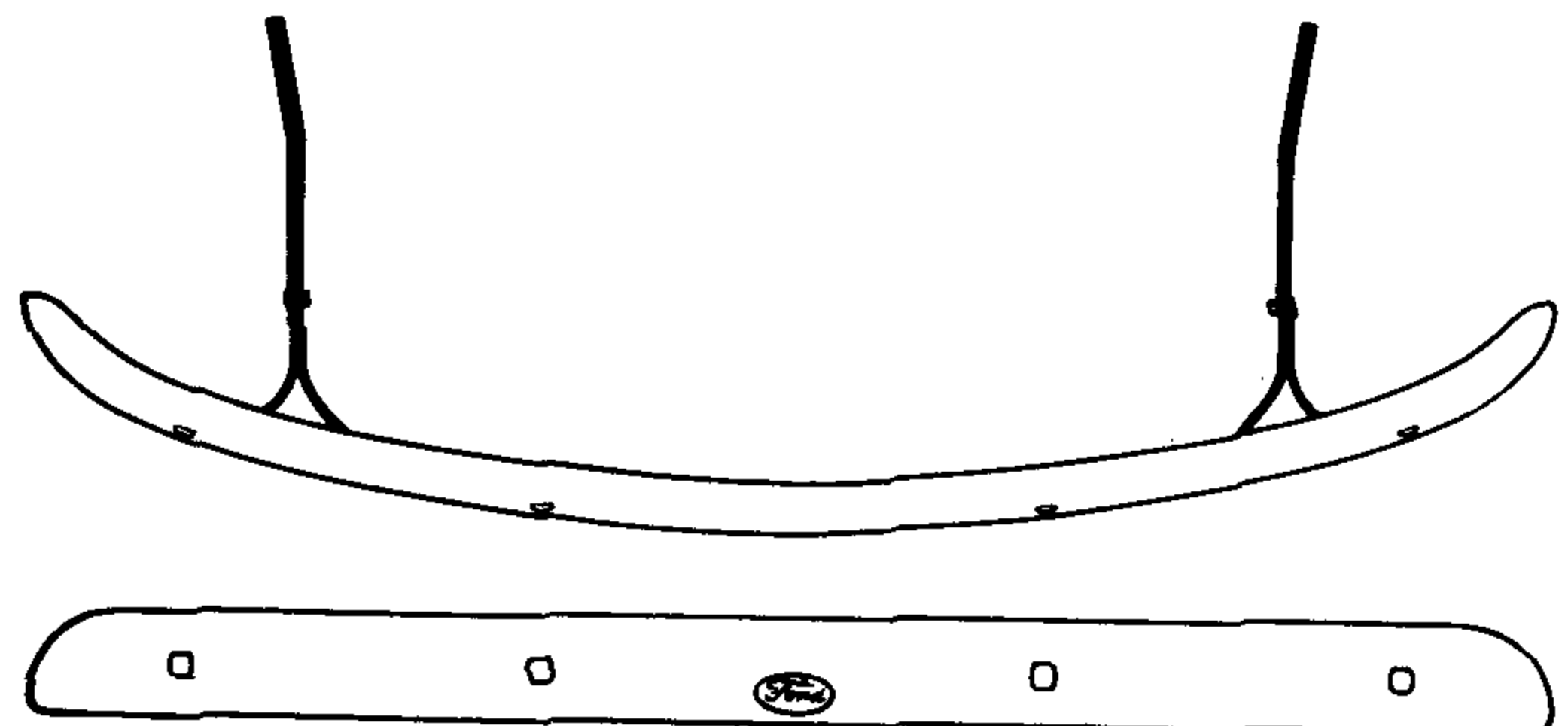

P 287

51A 17781	Bar (impact)	1
21A 17787-C	Arm (inner)-RH	1
21A 17788-C	Arm (inner)-LH	1
21A 17795-C	Arm (outer)-RH	1
21A 17796-C	Arm (outer)-LH	1
11A 17758	Bolt (arms to bar)	4
+20472-S	Bolt (arm to frame)	4
23426-S7	Bolt (inner to outer arm)	2
34370-S8	Nut (inner to outer arm bolt)	2
33802-S8	Nut (outer arm to bar bolt)	4
33845-S8	Nut (arm to frame bolt)	4
34808-S8	Lockwasher (outer arm to bar bolt)	4
34849-S2	Lockwasher (arm to frame bolt)	4

1942-47

COMMERCIAL WITH PICKUP OR PLATFORM BODY

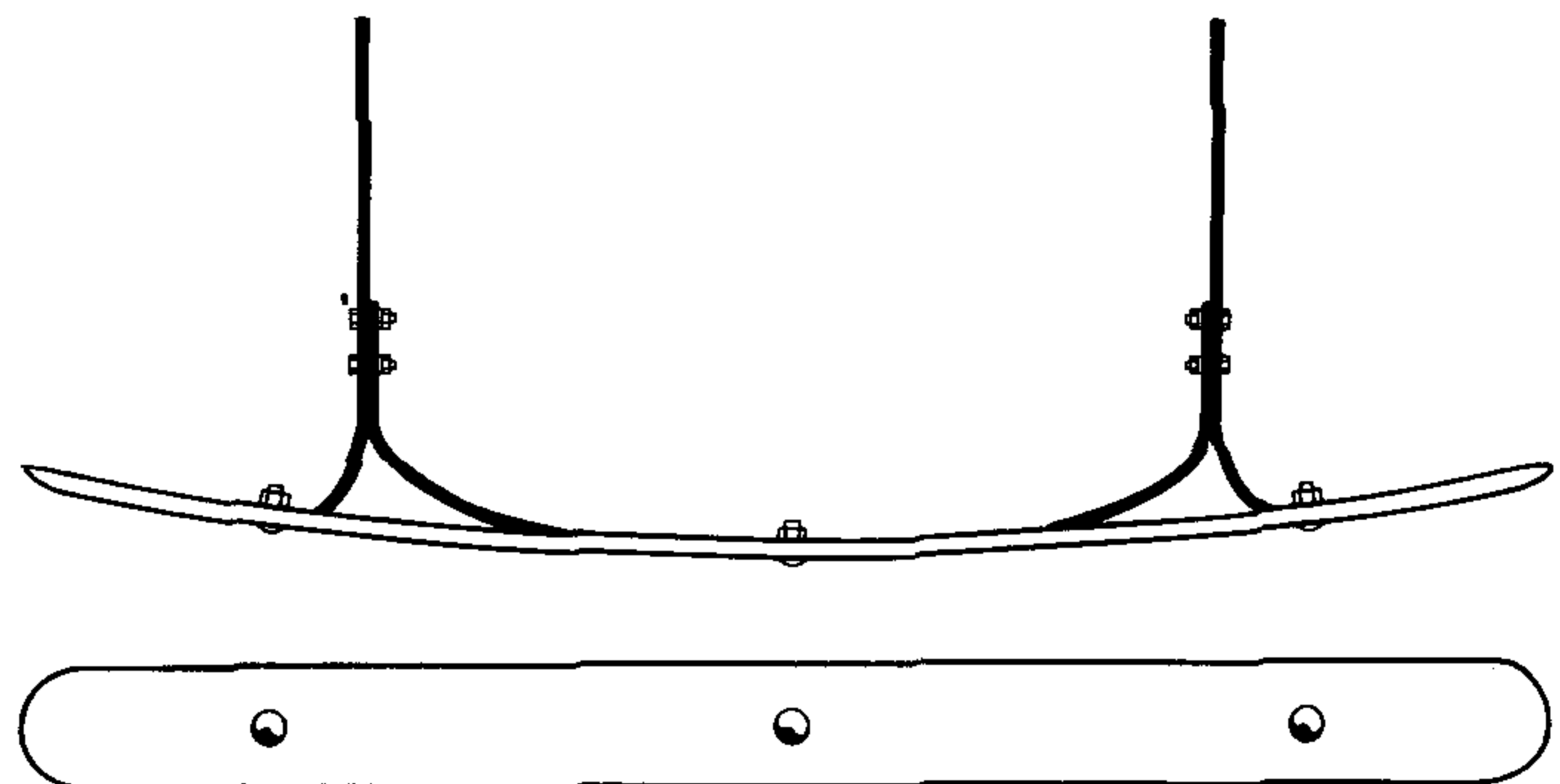

P-285

21C 17757	Bar	1
21C 17795-B	Arm (outer)-RH	1
21C 17796-B	Arm (outer)-LH	1
BB 17758	Bolt (arms to bar)	3
21C 17957-B	Reinforcement (outer arm)	1
+20472-S2	Bolt (arm to reinforcement)	4
+20472-S2	Bolt (arm to frame)	4
33845-S8	Nut (arm to frame bolt)	4
33845-S8	Nut (arm to reinforcement bolt)	4
33847-S7	Nut (arms to bar)	3
34810-S7	Lockwasher (arms to bar)	3
33849-S2	Lockwasher (arm to reinforcement)	4
34849-S2	Lockwasher (arm to frame bolt)	4

1942-47

TRUCK WITH PANEL BODY

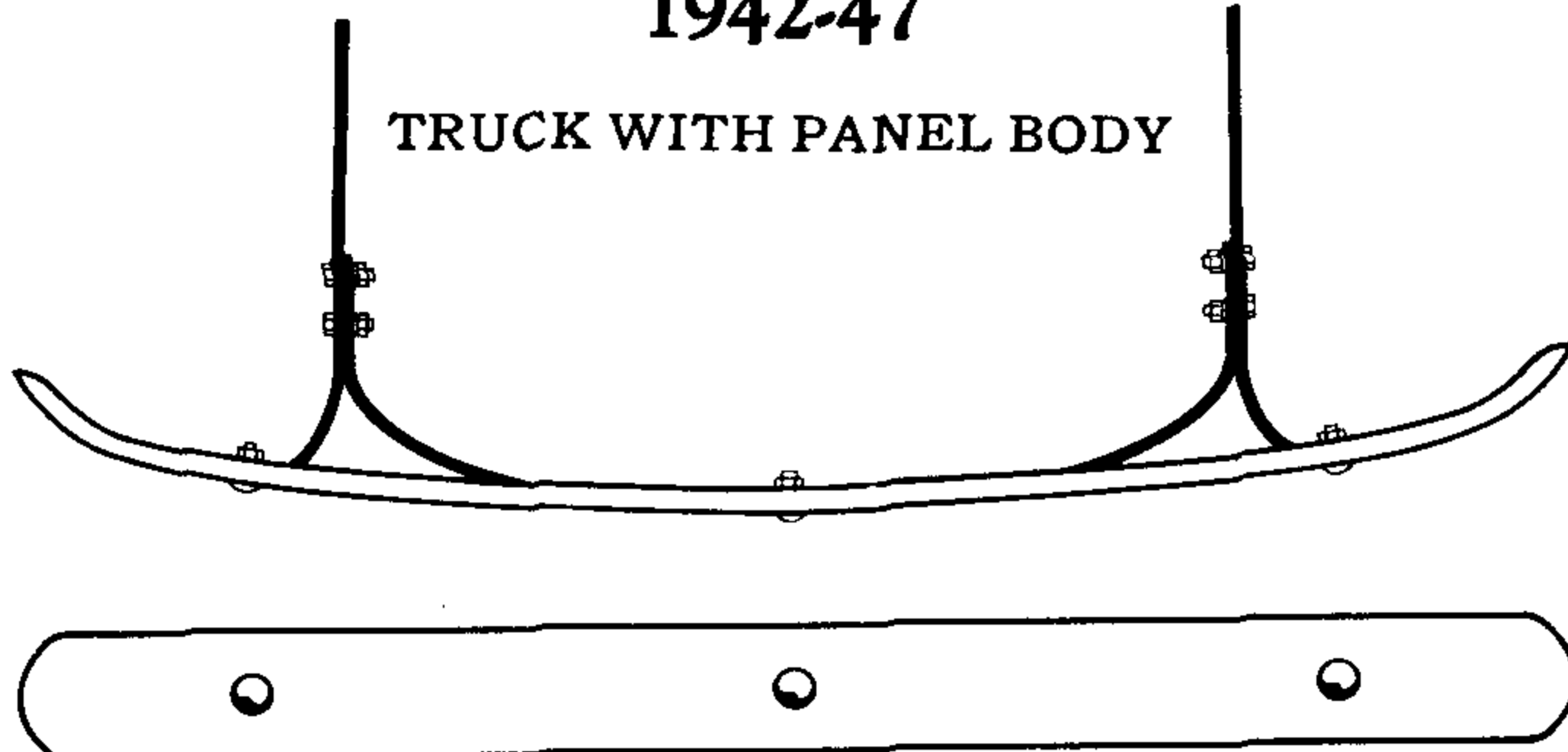

P-284

21T 17906	Bar (impact)	1
81T 17955	Arm (outer)-RH	1
81T 17956	Arm (outer)-LH	1
81T 17957	Reinforcement (bar)	1
BB 17758	Bolt (outer arm to bar)	2
+20472-S	Bolt (arm to reinforcement)	8
33845-S8	Nut (arm to reinforcement)	8
33847-S7	Nut (arms to bar)	3
34810-S7	Lockwasher (arms to bar)	3
34849-S2	Lockwasher	8
355743-S2	Bolt (reinforcement to bar)	1

† No Longer Supplied

CHASSIS PARTS CATALOGUE

PART NUMBER	PART NAME	NO. REQ'D	PART NUMBER	PART NAME	NO. REQ'D
-------------	-----------	-----------	-------------	-----------	-----------

Rear Bumper

1942-47

PANEL DELIVERY

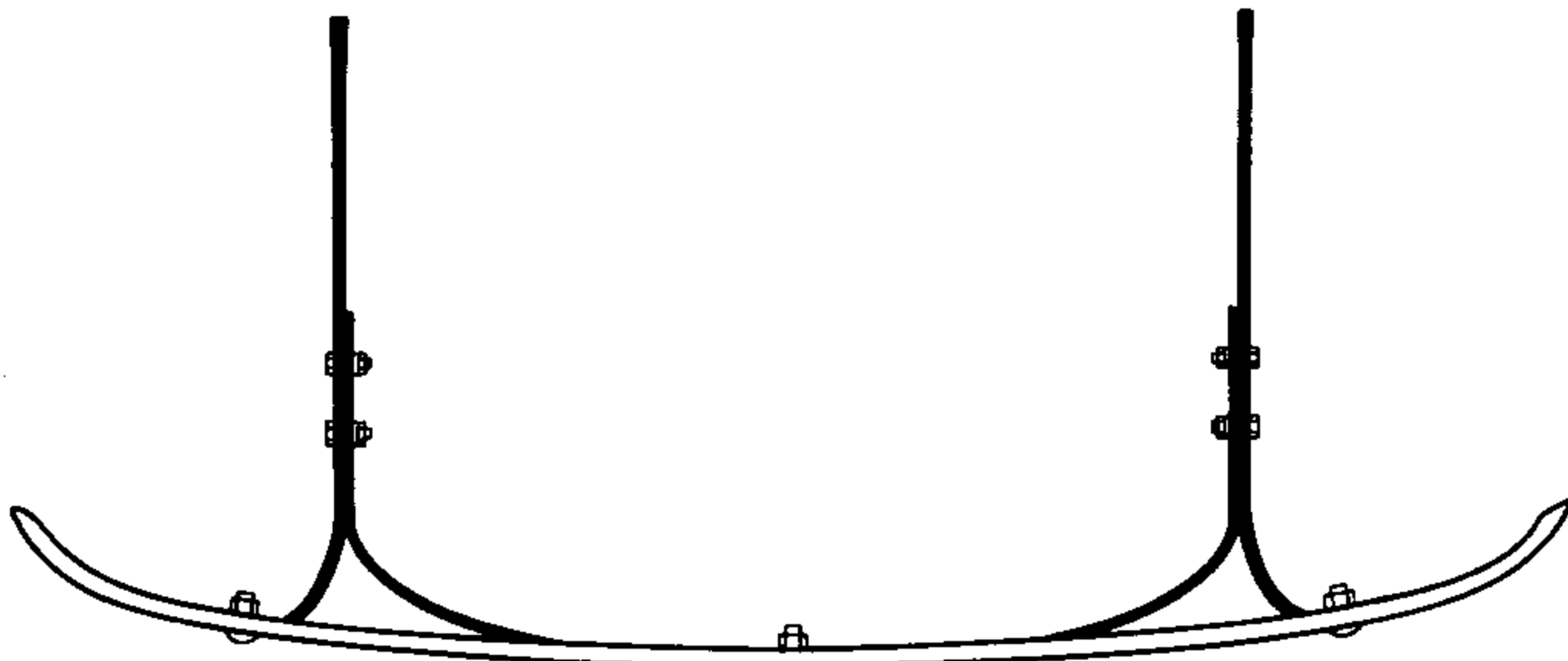

P-286

21T 17757-A	Bar (impact)-painted	1
21C 17795-A	Arm (outer)-RH	1
21C 17796-A	Arm (outer)-LH	1
BB 17758	Bolt (arms to bar)	3
21C 17957-A	Reinforcement(outer arm)	1
†20472-S	Bolt (arm to reinforcement)	4
†20472-S	Bolt (arm to frame)	4
33845-S8	Nut (arm to reinforcement bolt)	4
33845-S8	Nut (arm to frame bolt)	4
33847-S7	Nut (arms to bar)	3
34810-S7	Lockwasher (arms to bar)	3
34847-S8	Lockwasher (arm to reinforcement)	4
34849-S2	Lockwasher (arm to frame bolt)	4

1947-48

**PASSENGER EXCEPT STATION WAGON, SEDAN
DELIVERY AND SPORTSMAN COUPE)**

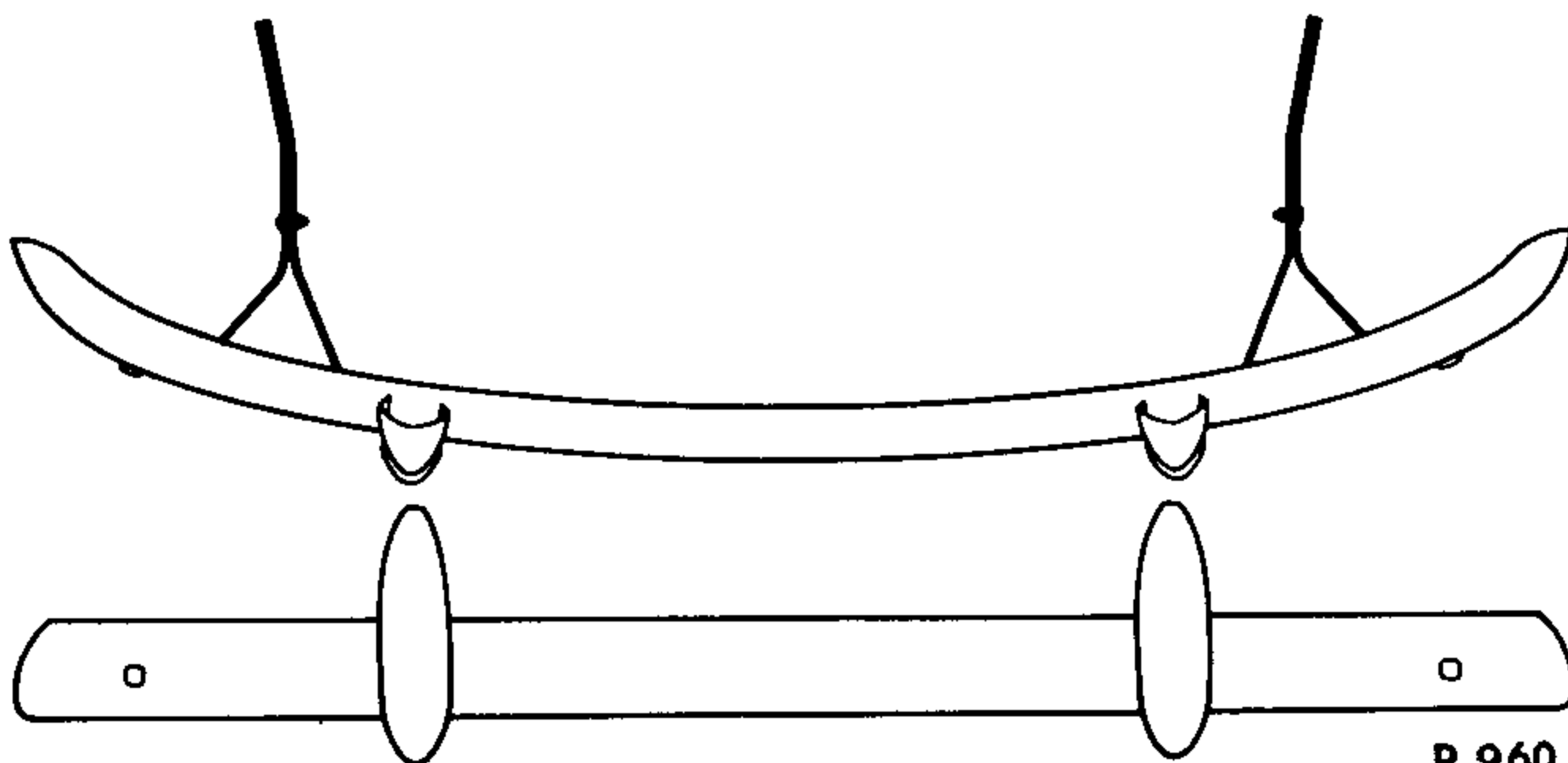

P-960

6A 17781	Bar (rear bumper)	1
6A 17787-A	Arm (inner)-RH	1
6A 17788-A	Arm (inner)-LH	1
6A 17795-A	Arm (outer)-RH	1
6A 17796-A	Arm (outer)-LH	1
23426-S7	Bolt (outer arm to inner arm)	2
34370-S8	Nut (outer arm to inner arm bolt)	2
11A 17758	Bol+ (outer arm to bar)	2

34397-S7	Locknut (outer arm to bar bolt)	2
44731-S8	Washer (outer arm to bar bolt)	2
6A 17984-A	Guard (bumper)-RH	1
6A 17985-A	Guard (bumper)-LH	1
20527-S2	Bolt (bumper guard to bar)	2
34909-S8	Lockwasher (bumper guard to bar bolt)	2
44736-S8	Washer (bumper guard to bar bolt)	2

1947-48

SPORTSMAN COUPE

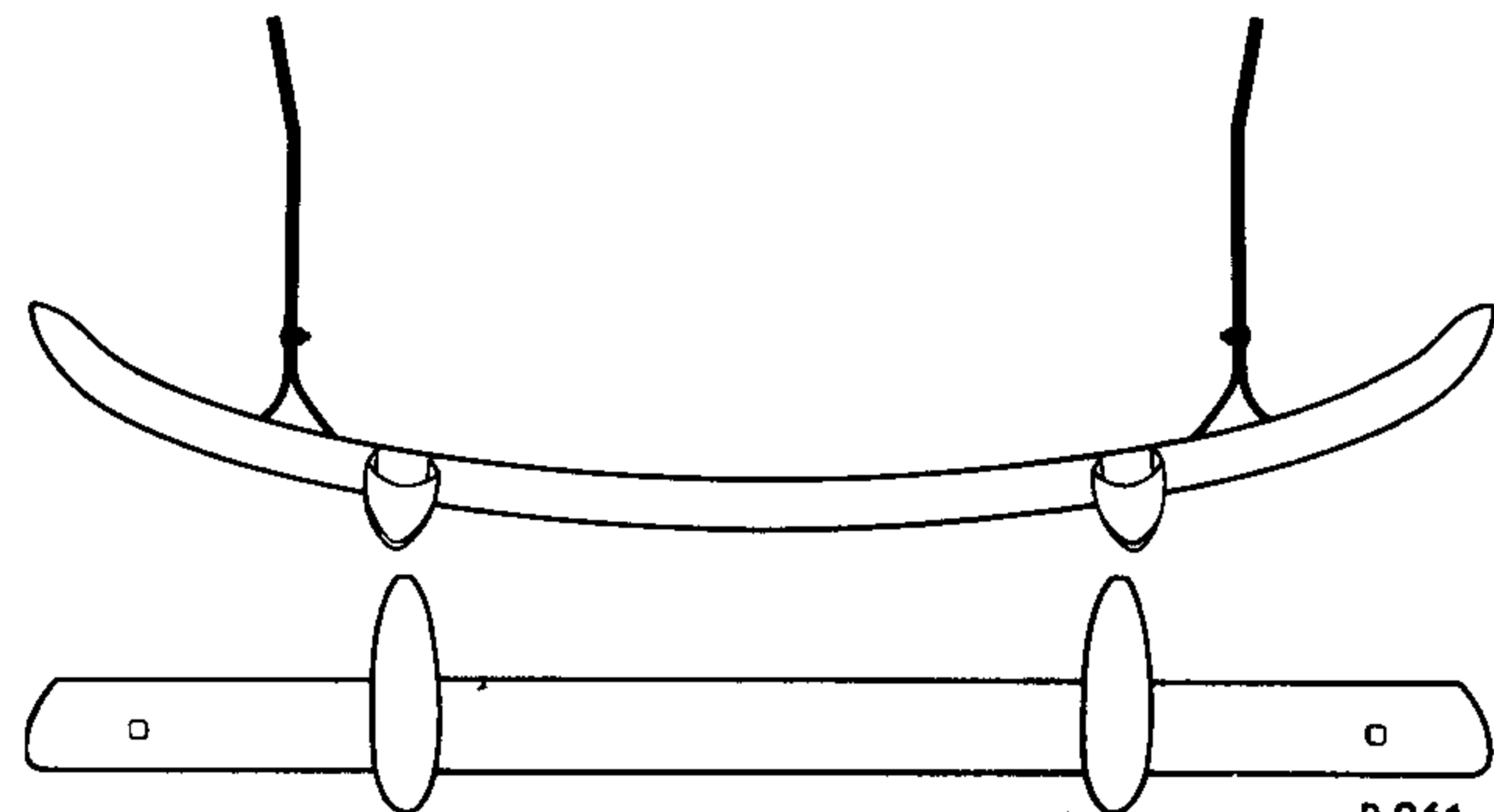

P-961

6A 17781	Bar (bumper impact)	1
6A 17787-B	Arm (inner)-RH	1
6A 17788-B	Arm (inner)-LH	1
51A 17795	Arm (outer)-RH	1
51A 17796	Arm (outer)-LH	1
23426-S7	Bolt (outer arm to inner arm)	2
34370-S8	Nut (outer arm to inner arm bolt)	2
11A 17758	Bolt (outer arm to bar)	2
34397-S7	Locknut (outer arm to bar bolt)	2
44731-S8	Washer (outer arm to bar bolt)	2
6A 17984-A	Guard (bumper)-RH	1
6A 17985-A	Guard (bumper)-LH	1
24519-S2	Bolt (bumper guard to bar)	2
34809-S8	Lockwasher (bumper guard to bar bolt)	2



CHASSIS PARTS CATALOGUE

PART NUMBER	PART NAME	NO. REQ'D	MODEL	YEAR 19__
-------------	-----------	-----------	-------	--------------

Accessories

Battery Corrosion Arrestor

51A 10682	Arrestor assy (battery corrosion)	2	(Pass 1928-48)(Comm, Trucks 1928-47)	28-48
-----------	-----------------------------------	---	--------------------------------------	-------

Wheel Bands

01A 18303	Ring (wheel trim)-set of 5-chrome	1	Pass except Std	40-47
6A 18303-C	Ring (wheel trim)	5	Pass	47-48

Fuel Tank Locking Cap

01A 18416-A	Cap (fuel tank locking)-chrome			38-48
-------------	--------------------------------	--	--	-------

Clocks

78 13466	Bulb (clock)-2 CP-single contact	1	Pass	38-48
51A 14526-A	Fuse (electric clock)-2 ampere	1	Pass (8 cyl)	46-48
51A 14526-B	Fuse (electric clock)-3 amp	1	Pass	46-48
†78 15001-B	Retainer (stem wind clock)	1	Pass	37
†81A 15001	Retainer (stem wind clock)	1	Pass	38-39
†21A 15002-A	Clock (windup)-LHD	1	Pass-Super DeLuxe	42
†21A 15005-A	Clock (windup)-LHD	1	Pass-Special & DeLuxe	42
51A 15005-C	Clock (electric)-LHD-hands chromium plate	1	Pass-Super DeLuxe, Sportman, Station Wagon, Convertible	46-47
6A 15005-A	Clock assy (electric)-LHD	1	Pass	47-48
	32917-S7 Screw (clock retainer to glove compartment door)		Pass-DeLuxe	39-40
	36799-S7 Screw (clock retainer to glove compartment door)		Pass-DeLuxe	38
	34802-S7 Washer (clock retainer to glove compartment door)		Pass-DeLuxe	38
48 15021	Bulb (glove compartment clock)-single contact-6-8 volt, 1.0 C.P.	1	Pass	35-36
91A 15026-C	Wiring assy (windup clock)	1	Pass-DeLuxe	39-40
	B-14586 Clip (glove compartment clock connecting wire to instrument panel)	2	Pass-DeLuxe	38
11A 15026	Wiring (windup clock)	1	Pass-Super DeLuxe	41-42
21A 15026-B	Wiring (windup clock)-LHD	1	Pass	42
59A 15026	Wiring assy (electric clock)	1	Pass	46-48
†48 15027	Connector (clock wiring)	1	Pass	35-37
†91A 15027	Wire (electric clock connector)	1	Pass	39
78 15032	Knob (wind-up clock)	1	Pass	37
†01A 15032	Knob (windup clock)	1	(Pass-DeLuxe 1939)(Pass-Std 1940)	39-40
†78 15036	Cap (clock fuse socket)	1	Pass	37

† No Longer Supplied



CHASSIS PARTS CATALOGUE

PART NUMBER	PART NAME	NO. REQ'D	MODEL	YEAR 19
-------------	-----------	--------------	-------	------------

Accessories

Draft Deflectors

†68 18294	Glass (draft deflector)	2	Pass, Sedan Delivery except Convertibles	35-38
81A 18294	Glass (draft deflector)	2	Pass	38-39
	350248-S13 Bolt (windshield deflector)- acorn head	2	Pass	38-39
	32944-S2 Screw (frame to door)	8	Pass	38
	34806-S2 Lockwasher (frame to door)	8	Pass	38
	72003-S7 Cotter pin (frame to door)	2	Pass	38
	350805-S Nut (frame to door)	2	Pass	38
	34029-S2 Nut (frame to door)	2	Pass	38
	351344-S Washer (frame to door)	2	Pass	38
48 18755-B	Weatherstrip (glass retaining)-30 ft. per carton	As Reqd	(Pass 1928-48)(Comm, Trucks 1928-47)	28-48
40 18971	Weatherstrip (window header)-36" long in carton	1	(Pass 1928-48)(Comm, Trucks 1928-47)	28-48
48 18972	Weatherstrip (glass channel)-in carton	1	(Pass 1928-48)(Comm, Trucks 1928-47)	28-48

Exhaust Deflector

51A 18259-B	Deflector assy (exhaust)-with jewel	1	Pass	41-48

Tire Inflator and Fire Extinguisher

†51A 17940	Tire inflator & fire extinguisher	1	Pass	47-48
†6A 17942	Bracket assy (fire extinguisher)	1	Pass	47-48
†6A 18365	Kit (tire inflator & fire extinguisher)	1	Pass	47-48

Thermostatic Control Fan

59A 8654	Thermostat assy (fan control)	1	Pass (8 cyl)	42-48
59A 8664	Wire assy (thermostat to fan)-6 1/2" long	1	Pass (8 cyl)	42-48
59A 14437	Wire assy (thermostat to fan)	1	Pass (8 cyl)	42-48
59A 8665	Kit (thermostatic control fan)	1	Pass (8 cyl)	42-48
	353256-S Clip (thermostatic fan wire)	1	Pass (8 cyl)	42-48
	353257-S Clip (thermostatic fan wire)	4	Pass (8 cyl)	42-48

License Plate Frames

APA 13350	Frame kit (license plate)-consists of 12 frames & display carton	1		32-48

† No Longer Supplied



CHASSIS PARTS CATALOGUE

PART NUMBER	PART NAME	NO. REQ'D	MODEL	YEAR 19__
-------------	-----------	-----------	-------	--------------

Accessories

Governor

40 6856	Lever (carburetor accelerator pump)	1	90 & 100 HP (8 cyl)	34-42
21A 9488	Gasket (carburetor to governor)-use with 8RC 18204-A,B	1	90 & 100 HP (8 cyl)	38-48
81A 18204-A	Kit (engine governor)-use with Stromberg Carburetor	1	90 & 100 HP (8 cyl)	34-47
81A 18204-B	Kit (engine governor)-use with Chandler Groves Carburetor	1	90 & 100 HP (8 cyl)	38-48
1GA 18204-A	Kit (engine governor)	1	6 cyl "G" Series	41-47
	357693-S Stud (governor)	1	6 cyl "G" Series	41-47
8HC 18204-B	Governor (engine)-1500-2500 R.P.M.	1	6 cyl "H" Series	47-48
8HC 18204-C	Governor (engine)-2000-3500 R.P.M.	1	6 cyl "H" Series	47-48
8RC 18204-A	Governor (engine)-1500-2500 R.P.M.	1	90 & 100 HP (8 cyl)	38-48
8RC 18204-F	Governor (engine)-2000-3500 R.P.M.	1	90 & 100 HP (8 cyl)	38-48
81A 18210	Gasket (engine governor to carburetor)-for 81A-18204-A,81A-18204-B,8RC-18204-A,B	1	90 & 100 HP (8 cyl)	38-48
	21A-9488 Gasket (carburetor to governor)	1	8 cyl	42
†1GA 18210	Gasket (governor to carburetor)-Monarch Design	2	6 cyl "G" Series	41-47
51A 18210	Gasket (governor to carburetor)-King-Seeley Design	2	6 cyl "G" & "H" Series	41-48
†81A 18211	Bushing (engine governor to carburetor)-for 81A-18204-B	1	8 cyl	38
81A 18212	Extension (engine governor carburetor throttle)-for 81A-18204-B	1	8 cyl	38
	20331-S7 Screw (governor extension bracket)	1	8 cyl	38
81A 18213	Lever (engine governor carburetor throttle)-for 81A-18204-B & 8RC-18204-A,B	1	90 HP & 100 HP	38-48
8HC 18216	Tube (carburetor to governor)-3/16" O.D. x 12 1/4" long-cut from 8C 2269-B	1	6 cyl "H" Series	47-48
		1	90 & 100 HP (8 cyl)	38-48
ONY 18223	Cover (governor opening)	1	4 cyl	41-42
8HC 18226	Tube (carburetor to distributor extension)-3/16" O.D. x 1.76" long-cut from 8C 2269-B	1	6 cyl "H" Series	47-48
		1	90 & 100 HP (8 cyl)	38-48
	352676-S Stud (carburetor & governor to engine)	1	(Pass 1933-41)(Trucks 1932-37)(Comm 1933-41)	32-41
81A 18257	Seal assy (engine governor)-was 81A-6854	1	Pass,Comm,Trucks	38-48

Center and End Bumper Guard

†11A 18383-B	Guards (bumper end)-RH & LH-in carton	2	(Super DeLuxe 1941)(Special & DeLuxe 1942)	41-42
01A 18415	Back plate (center guard)	1	Pass	40

† No Longer Supplied

Accessories

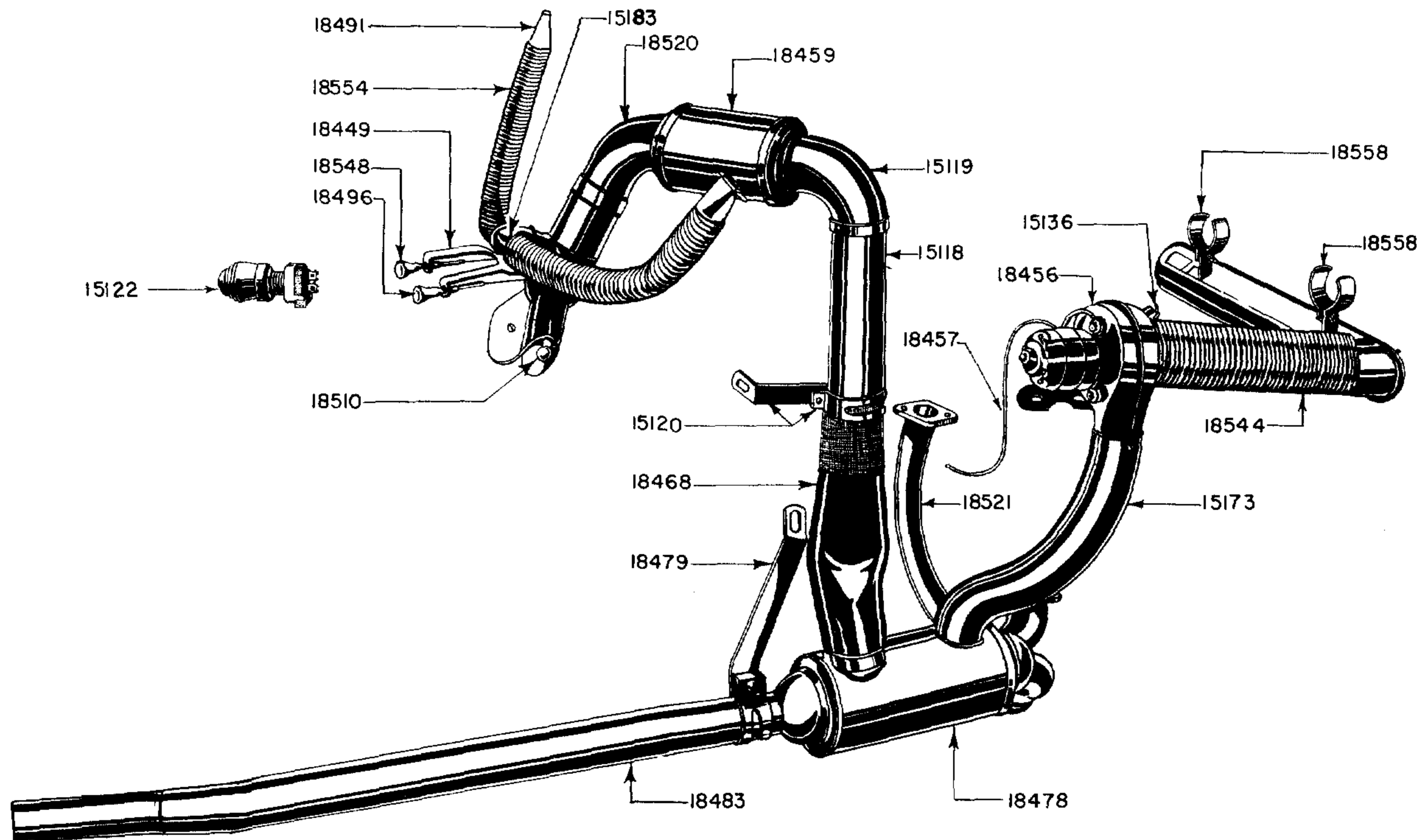

P-46

1940 HOT AIR HEATER

Basic numbers only shown on illustration. Order by Part Numbers shown in list of parts.

PART NUMBER	PART NAME	NO. REQ'D	MODEL	YEAR 19__
-------------	-----------	-----------	-------	--------------

Accessories**Hot Air Heater**

21C 13740	Switch (hot air heater blower)	1	Pass	38
48 15021	Bulb (switch)	1	Pass	40-41
91A 15119	Elbow (hot air heater silencer air inlet)	1	Pass, Comm-90 & 100 HP	39-40
+01A 15120	Bracket (hot air silencer air inlet pipe)	1	Pass	40
01A 15122-A	Switch (hot air heater blower)	1	Pass, Comm-90 & 100 HP	39-40
21A 15122-A	Switch (hot air heater blower)	1	Pass, Sedan Delivery	41-42
01A 15136	Valve (hot air heater adapter)-blower housing	1	Pass (6 & 8 cyl)	40-42
91A 15169	Housing, bracket & shutter (hot air blower)	1	Pass, Comm-90 & 100 HP	39
74 15173	Tube (hot air heater blower)	1	Pass-60 HP	38-39
+78 15173-B	Tube (hot air heater blower)	1	Pass-90 HP	38
+81A 15173	Tube (hot air heater blower)-use to convert funnel type heater to blower type	1	Pass-90 HP	38
01A 15173	Tube (hot air heater blower)	1	Pass	39-42
2GA 15173	Tube (hot air blower)	1	Pass (6 cyl)	42
91A 15177	Pipe & bracket (hot air heater defroster cross over)	1	Pass, Comm, 1 Ton Truck-90 HP	39
+01A 15183-A	Fitting (hot air heater defroster)-"Y" type	1	Pass	40
+91A 15185	Elbow (hot air heater defroster)	2	Pass, Comm-90 & 100 HP	39
91A 18445	Adapter (hot air heater defroster pipe)	1	Pass	39
+91A 18449	Bracket (hot air heater valve control cable)	1	Pass, Comm-90 & 100 HP	39
+01A 18449	Bracket (hot air heater control support)	1	Pass	40
11A 18449	Bracket (hot air heater control)	1	Pass, Sedan Delivery	41
21A 18449	Bracket (hot air heater control support)-replaced by 6A-18597-A	1	Pass (6 & 8 cyl)	42
+11A 18456	Blower (hot air heater)	1	Pass, Comm	40-42
+99A 18457	Wire (hot air heater motor)	1	Pass-90 HP (6 & 8 cyl)	39-42

† No Longer Supplied



CHASSIS PARTS CATALOGUE

PART NUMBER	PART NAME	NO. REQ'D	MODEL	YEAR
-------------	-----------	-----------	-------	------

Accessories

91A 18459	Silencer (hot air heater)	1	Pass, Comm-90 & 100 HP	39
+01A 18459	Silencer (hot air heater)	1	Pass	41-42
+2GA 18459	Silencer (hot air heater)	1	Pass (6 cyl)	42
11A 18463	Bag of heater connecting parts	1	Pass, Comm	41
11T 18463	Bag of heater connecting parts	1	Trucks	41
40 18465	Hose (hot air heater to front register)	1	Pass, Comm (8 cyl)	33-35
40 18465	Hose (asbestos)	1	Pass, Comm, Trucks-90 HP	37
79 18465-B	Hose, spring & clamp (hot air heater to front register asbestos)	1	Trucks-90 & 100 HP	37-39
2GA 18465	Hose & clamp (hot air heater asbestos)	1	Pass (6 cyl)	42
01A 18468	Pipe & bracket (hot air heater air inlet)	1	Pass	40
01A 18468	Pipe (hot air heater to asbestos hose)	1	Pass, Comm-90 HP	39
11A 18468	Pipe (hot air heater air inlet)	1	(Pass 1941-42)(Sedan Delivery 1941)	41-42
21A 18471	Pipe (hot air heater distributing)-RH	1	Pass	42
21A 18472	Pipe (hot air heater distributing)-LH	1	Pass	42
+91A 18478-A	Unit (hot air heater)	1	Pass, Comm-90 & 100 HP	39-40
21A 18478-A	Unit (hot air heater)	1	Pass	42
2GA 18478	Unit (hot air heater)	1	Pass (6 cyl)	42
+91A 18479	Bracket (hot air heater support)	1	Pass, Comm-90 & 100 HP	39
91T 18479	Bracket (hot air heater support)	1	1 Ton Truck	39
11A 18479	Bracket (hot air heater support)	1	Pass	40-42
2GA 18479	Bracket (hot air heater support)	1	Pass (6 cyl)	42
74 18483-B	Pipe (hot air heater to muffler inlet)	1	Pass-60 HP	37-39
+99A 18483	Pipe (hot air heater to muffler)	1	Pass, Comm-90 & 100 HP	38-41
2GA 18483	Pipe (hot air muffler inlet)	1	Pass (6 cyl)	42
+78 18491-B	Nozzle (hot air heater defroster)-open cars	1	(Pass-60 HP 1938-39)(Pass-90 HP 1937-38)	37-39
01A 18491-A	Nozzle (hot air heater defroster)	1	Pass	40
+11A 18491-A	Nozzle (hot air heater defroster)	2	Pass	41-42
78 18492-B	Valve & tube assy (hot air defroster)-use with remote control	1	Pass, Comm, Trucks-60 & 90 HP	38-39
91T 18496	Cable (hot air heater control)	1	Trucks	39
+09A 18496	Cable (hot air heater control)	1	Pass	40
21A 18496	Cable (hot air heater control)	1	(Pass, Sedan Delivery 1941)(Pass 1942)	41-42
11A 18497	Register (hot air heater)	1	Pass, Sedan Delivery	41
+78 18499-B	Clamp (hot air heater asbestos hose)	1	Pass, Comm	38-42
78 18507	Clamp (hot air heater muffler outlet pipe "U")	1	Pass, Comm, 1 Ton Truck	32-39
	21A 5251 Clamp assy-"U"	1	Pass-60 HP	37
+01A 18510	Deflector (hot air heater)	1	Pass	40
+01A 18520	Elbow (hot air heater)	1	Pass	40
+78 18521-B	Pipe (hot air heater exhaust cross over)	1	Pass, Comm-90 & 100 HP	38-40
99A 18526-A	Plug (defroster opening end)	4	Pass	41-48
01A 18526-A	Plug (defroster opening end)	4	Pass, Sedan Delivery, Closed Cabs, Panels (except 1946-47 COE)	40-47
21A 18543	Shroud & clamp (hot air heater)	1	Pass	42
2GA 18543	Shroud & filter (hot air heater)	1	Pass (6 cyl)	42
+19A 18544	Tube (hot air heater shroud)	1	Pass	40-42
+78 18545	Tube (hot air heater to defroster)-flexible	1	(Pass-60 HP 1938-39)(Pass-90 HP 1937-38)	37-39
91A 18547	Bracket (defroster pipe)	1	Pass-90 HP	39
91T 18548	Cable (hot air defroster valve control)	1	Trucks	39
+09A 18548	Cable (hot air heater defroster control)	1	Pass	40
11A 18548-A	Cable (hot air heater defroster control)	1	Pass, Sedan Delivery	42-48
21A 18548-A	Cable (hot air heater defroster control)	1	Pass	46-48
78 18550	Hose & clamp (hot air heater auxiliary asbestos)	1	(Pass-60 HP 1938-39)(Pass-90 HP 1938)	38-39
09A 18554	Hose (hot air heater flexible)	1	(Pass 1940-42)(Sedan Delivery 1941)	40-42
11A 18558	Clamp (hot air heater shroud)	1	(Pass, Comm 1940-41)(Pass 1940-47)	40-47
99A 18588	Hose & spring (hot air heater asbestos)	1	(Pass-60 HP 1938-39)(Pass-90 HP 1935-39)	35-39
2GA 18588	Hose (hot air heater asbestos)	1	(Pass 1941-42)(Sedan Delivery 1941)	41-42
11A 18589	Support (hot air heater hose form)	1	(Pass 1941-42)(Sedan Delivery 1941)	41-42

+ No Longer Supplied



CHASSIS PARTS CATALOGUE

PART NUMBER	PART NAME	NO. REQ'D	MODEL	YEAR 19__
Accessories				
Hot Water Heater				
†51A 14309-A	Wire assy (hot water heater switch jumper)-23" long	1	Pass, Trucks except COE	46-48
†51A 14309-B	Wire assy (hot water heater switch jumper)-6.5" long	1	Pass, Trucks except COE	46-48
8C 14309-B	Wire assy (fresh air heater switch jumper)-8 1/2" long-has 20 amp fuse	1	Pass (8 cyl)	47-48
01A 15122-A	Switch (hot water heater blower)	1	Comm, Trucks-90 & 100 HP	41
01A 15122-B	Switch (hot water heater blower)	1	Pass, Comm, Trucks-90 & 100 HP	39-41
21A 15122-B	Switch (hot water heater blower)-replaced by 8C-18578-A	1	(Pass 1942)(Comm, Trucks except COE 1945-47)	42-47
51A 15122-B	Switch (hot water heater blower)-replaced by 8C-18578-A	1	Pass (6 & 8 cyl)	45-48
51C 15122	Switch (hot water heater blower)-replaced by 8C-18578-A	1	Comm, Trucks except COE	45-47
11A 15129	Fan & blower (hot water heater)	1	Pass, Comm, Trucks-90 & 100 HP	41
11A 15129	Fan (hot water heater)-under seat	1	Pass	41
11A 15133	Core assy (hot water heater)	1	Pass-90 HP	41
11T 15133-A	Core assy (hot water heater)	1	Comm, Trucks	41
51A 15133-A	Core assy (hot water heater)	1	Pass	46-48
51A 15133-B	Core assy (hot water heater)	1	Pass	46-48
51T 15133-B	Core assy (hot water heater)	1	Comm, Trucks	41-47
91A 15142	Valve assy (hot water heater shut off)	1	Pass	40-48
91A 15145	Extension (hot water heater adapter)-on cylinder head	1	90 & 100 HP	39
11A 15149	Case (hot water heater)-front	1	Pass-90 HP	41
91A 15151	Bracket (hot water heater hose)-front	1	Pass-90 HP	39-41
91A 15152	Bracket (hot water heater hose)-rear	2	Pass, Trucks-90 & 100 HP	39-41
91A 15160-A	Nipple assy (lower hose)	1	Pass, Comm-90 & 100 HP	39-48
5GA 15167	Hose (hot water heater)-.59" I.D. x 30.0" long	1	Pass	46-48
11A 15199	Valve (shut off)-for under seat type heater	1	Pass	41
11A 15199	Valve (hot water heater shut off)-replaced by 91A-15142	1	Pass, Trucks-90 & 100 HP	39-41
6A 16629	Deflector assy (air)-used with fresh air hot water heater	1	Pass (8 cyl)	47-48
11A 18450	Spacer (hot water heater to dash)	1	Pass, Sedan Delivery-90 HP	41
1GA 18451	Kit (hot water heater adapter)-use when installing on 6 cylinder	1	(Pass 1941-47)-6 cyl (Comm, Trucks 1941-47)-6 cyl	41-47
51A 18455-B	Heater & defroster assy (hot water)-recirculating replaced by 51A-18455-F	1	Pass	46-48
† 51A 18455-F	Heater & defroster assy (hot water)-recirculating	1	Pass	47-48
† 51T 18455-A	Heater & defroster assy (hot water)	1	Trucks	46-47
† 6A 18455-A	Heater & defroster assy (hot water)-recirculating	1	Pass (8 cyl)	47-48
† 6A 18455-B	Heater & defroster assy (hot water)-fresh air	1	Pass (8 cyl)	47-48
6A 18456	Blower assy (fresh air heater)	1	Pass (8 cyl)	47-48
6A 18457	Duct assy (fresh air inlet)	1	Pass (8 cyl)	47-48
6A 18472-A	Hose (hot water heater)-.59" I.D. x 38" long	2	Pass (8 cyl)	47-48
6A 18476-A	Core assy (hot water recirculating heater)	1		47-48
6A 18476-B	Core assy (fresh air hot water heater)	1	Pass (8 cyl)	47-48
† 11A 18478-B	Unit (hot water heater)	1	Pass	41
6A 18478-B	Unit (hot water heater)-fresh air	1	Pass (8 cyl)	47-48
1GA 18481	Clamp (hot water heater kit)	3	Pass, Comm, Trucks (6 cyl)	42-47
91T 18491	Nozzle assy (hot water heater defroster)	1	Trucks-90 & 100 HP	39
11A 18491-B	Nozzle (hot water heater defroster)	2	Pass	41-48
11T 18491-B	Nozzle (hot water heater defroster)	2	Comm, Trucks except COE	41-47
7HA 18495	Valve assy (hot water heater shut off)	1	(Pass 1947-48)(Trucks 1947)(6 cyl)	47-48
0A 18495	Valve assy (hot water heater shut off)	1	Pass, Comm, Trucks except COE (8 cyl)	47-48
51A 18519	Knob assy (hot water heater switch)	1	Pass	46-48
51C 18519	Knob assy (hot water heater switch)	1	Comm, Trucks	46-47

† No Longer Supplied



CHASSIS PARTS CATALOGUE

PART NUMBER	PART NAME	NO. REQ'D	MODEL	YEAR 19__
-------------	-----------	-----------	-------	--------------

Accessories

91A 18527-B	Motor (hot water heater)-includes wiring	1	Pass, Trucks-90 & 100 HP	39-40
11A 18527-B	Motor (hot water heater)	1	Pass, Comm, Trucks	41
21A 18527-B	Motor assy (hot water heater)-includes wiring	1	Pass, Comm, Trucks	42-47
6A 18527-A	Motor assy (hot water heater)-recirculating type	1	Pass (8 cyl)	47-48
6A 18527-B	Motor assy (hot water heater)-fresh air type	1	Pass (8 cyl)	47-48
11A 18542	Knob (underseat type heater control)	1	Pass	41
21A 18548-B	Control (hot water heater defroster valve flexible)	1	Pass	42
21T 18548	Control (hot water heater defroster valve flexible)	1	Trucks except COE	46-47
51A 18548-B	Control (hot water heater defroster valve flexible)	1	Pass	46-48
51T 18548	Control (hot water heater defroster valve flexible)	1	Comm, Trucks except COE	45-47
6A 18548-A	Control assy (hot water heater defroster)	1	Pass (8 cyl)	47-48
6A 18548-B	Control assy (fresh air heater)-air	1	Pass (8 cyl)	47-48
	01A-7004830-A Knob (hot water heater control)	1	Trucks-90 & 100 HP	39
01T 18556	Hose (hot water heater defroster)-30" long	2	Comm, Trucks except COE	40-47
6A 18556-C	Hose (defroster)-24 1/4" long	2	Pass (8 cyl)	47-48
11A 18562	Knob (hot water heater defroster)	1	Pass, Comm, Trucks	41
6A 18570-A	Gasket (blower mounting)	1	Pass (8 cyl)	47-48
6A 18570-B	Gasket (duct seal ring)	1	Pass (8 cyl)	47-48
7RA 18572-A	Clamp (hot water heater hose)-1" diameter	1	Pass	46-48
6A 18578-B	Switch assy (hot water heater)-fresh air	1	Pass (8 cyl)	47-48
8C 18578-A	Switch assy (hot water heater)	1	(Pass 1942-48)(Comm, Trucks except COE 1945-47)	42-48
51A 18597	Bracket (heater & defroster control)-has 2 holes	1	(Pass 1946-48)(Trucks except 122" 1946-47)	46-48
6A 18597-A	Bracket (fresh air heater control)-has 3 holes	1	Pass (8 cyl)	47-48
1GA 18599	Elbow (hot water heater connection)	2	Pass, Comm, Trucks (6 cyl "G" Series)	41-47
7RA 18599	Elbow (hot water heater water pump return)-replaced by 8A-18599	1	(Pass 1947-48)(Trucks except COE 1947) (8 cyl)	47-48
8A 18599	Elbow (hot water heater water pump return)	1	(Pass 1947-48)(Trucks except COE 1947) (8 cyl)	47-48

Hydraulic Jack

8A 17080-C	Jack assy (bumper)-hydraulic	1	Pass	46-48
------------	------------------------------	---	------	-------

Engine Compartment Lamp

B 13799	Bulb (engine compartment lamp)-15 CP	1	Pass Comm, Trucks except COE	37-48 42-47
51A 15700	Kit (engine compartment lamp)	1	Pass Comm, Trucks except COE	42-48 42-47
51A 15706	Switch (engine compartment lamp)	1	Pass Comm, Trucks except COE	42-48 42-47
+51A 15707	Spring (bulb contact)	1	Pass Comm, Trucks except COE	42-48 42-47
+51A 15709	Wiring (engine compartment lamp)	1	Pass Comm, Trucks except COE	42-48 42-47
8A 18375	Lamp assy (engine compartment)	1	Pass	37-48

† No Longer Supplied

Accessories

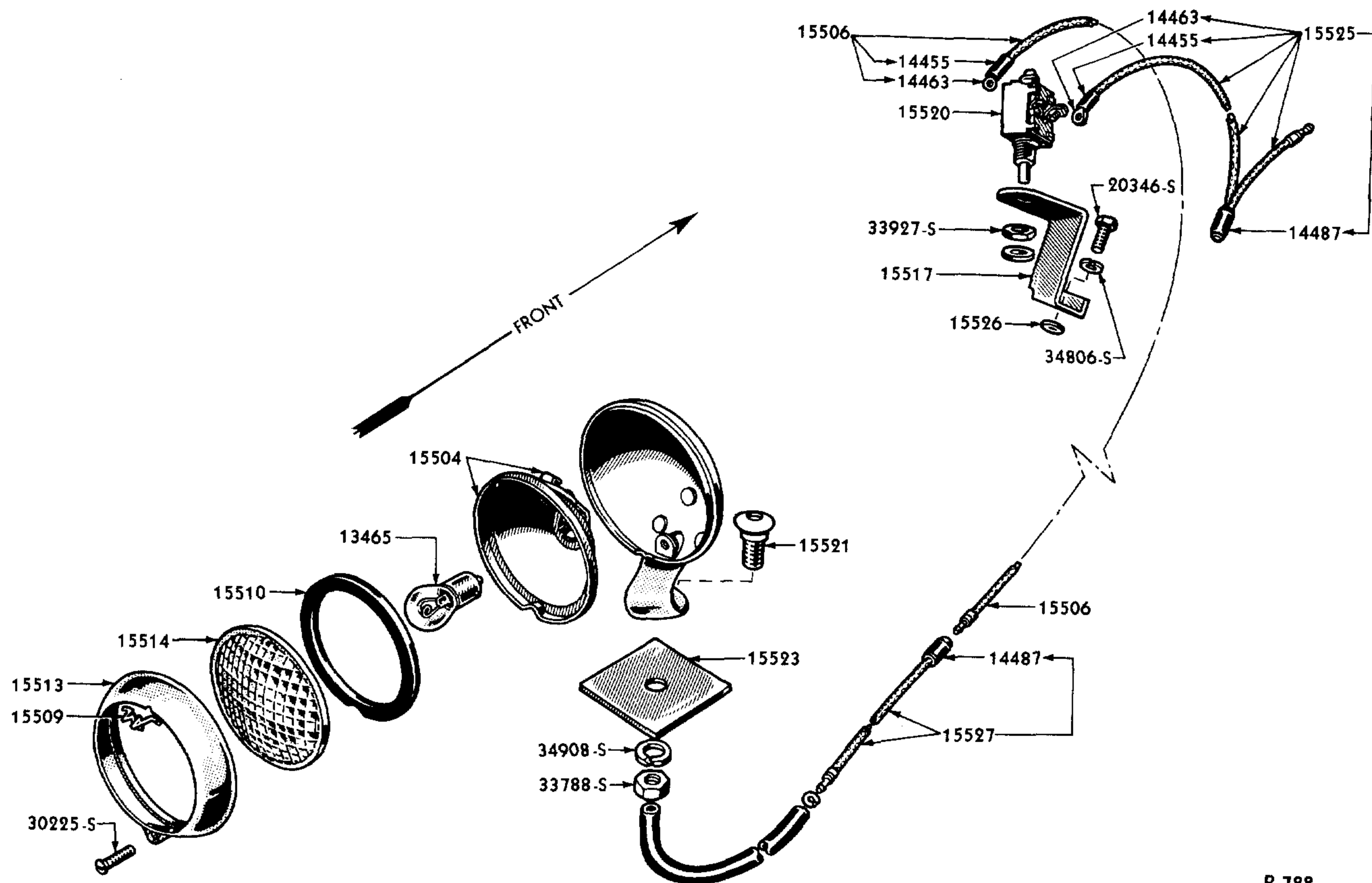

P-788

BACK UP LAMP

Basic numbers only shown on illustration. Order by Part Numbers shown in list of parts.

PART NUMBER	PART NAME	NO. REQ'D	MODEL	YEAR
-------------	-----------	-----------	-------	------

Accessories

Back Up Lamp

B 13465	Bulb (back up lamp)-21 CP-single contact	1	Pass	42-48
B 14455	Sleeve (back up lamp wire to switch)	2	Pass	42-48
B 14463	Terminal (back up lamp wire)	2	Pass	42-48
B 14487	Connector (wire & sleeve)	1	Pass	42-48
51A 15500	Lamp assy (back up)	1	Pass	42-48
51A 15504	Reflector (back up lamp)	1	Pass	42-48
51A 15506	Wire (back up lamp)-154" long	1	Pass	42-48
51A 15509	Spring (back up lamp door)	1	Pass	42-48
51A 15510	Gasket (back up lamp)	1	Pass	42-48
51A 15513	Door (back up lamp)	1	Pass	42-48
	30225-S13 Screw (door)	1	Pass	42-48
51A 15514	Lens (back up lamp)	1	Pass	42-48
51A 15517	Bracket (back up lamp switch mounting)	1	Pass	42-48
	20346-S2 Bolt (back up lamp switch mounting bracket)-5/16"-18 x 3/4"	1	Pass	42-48
	34806-S2 Lockwasher-5/16"			
51A 15520-A	Switch (back up lamp)	1	Pass	42-48
51A 15521	Stud (back up lamp mounting)-7/16"-20 x 1"	1	Pass	42-48
+51A 15523	Washer (back up lamp bottom)-2.5" square	1	Pass	42-48
+51A 15525	Wire (back up lamp feed)	1	Pass	42-48

† No Longer Supplied



CHASSIS PARTS CATALOGUE

PART NUMBER	PART NAME	NO. REQ'D	MODEL	YEAR
-------------	-----------	-----------	-------	------

Accessories

51A 15526	Washer (back up lamp switch mounting bracket spacer)-.33" I.D. x .60" O.D.	1	Pass	42-48
51A 15527	Wire (back up lamp)-35" long	1	Pass	42-48
	34908-S2 Lockwasher (back up lamp mounting stud)	1	Pass	42-48
	33788-S7 Nut (back up lamp mounting stud)	1	Pass	42-48
	33927-S7 Nut (back up lamp mounting bracket to switch)	1	Pass	42-48
†51A 18275	Kit (back up lamp)	1	Pass	42-48

Road Lamp

21A 14487	Connector (road lamp wire)-"Y" type	1	(Pass 1941-48)(Comm, Trucks 1941-47)	41-48
51A 15204	Plate (road lamp bracket)	1	Pass	46-48
51A 15206	Bracket (road lamp reinforcement)	1	Pass	46-48
†11A 15207	Adapter (road lamp)-use with 11A-15220-C-4.62" O.D.	1	Pass	41-48
21T 15207	Adapter (road lamp)-5.88" O.D.	1	Comm, Trucks except COE	40-47
51A 15208	Spacer (road lamp bracket)	1	Pass	46-48
78 15209-B	Bracket (road lamp)-short	1	Pass	38-40
01A 15209	Arm (road lamp)-bracket-Unity Design	1	(Pass 1940)(Comm, Trucks 1942-47)	40-47
†21A 15209	Arm (road lamp)-bracket-Unity Design	1	Pass	42
51A 15209	Arm (road lamp mounting)-use with 5.25" diameter lamp	1	Pass	46-48
78 15211	Clamp (road lamp bracket lower)-Unity Design	1	(Pass 1938-42)(Comm, Trucks 1942-47)	38-47
21A 15211	Plate (road lamp reinforcement)	1	Pass	42
†51A 15211	Washer (road lamp mounting)-use with 5.25" diameter lamp	1	Pass	46-48
78 15214	Door (road lamp)	1	Pass	38-39
01A 15214-A	Door (road lamp)-Unity Design	1	Pass	40-41
01A 15214-B	Door (road lamp)	2	Trucks	41-47
11A 15214-A	Door (road lamp)-Appleton Design	1	Pass	41
11A 15214-B	Door (road lamp)-split-Unity Design-use with a 5.25" diameter lamp	1	Pass	46-48
21A 15214-A	Door (road lamp)-Unity Design-polished	1	Pass	42
21A 15214-B	Door (road lamp)-painted	1	Trucks	44
51A 15214	Door (road lamp)-Unity Design-use with a 5.25" diameter lamp	1	Pass	46-48
78 15215	Lens (road lamp)	1	Pass	38-39
01A 15215	Lens (road lamp)	1	Pass	40-41
21A 15215	Lens (road lamp)-Amber color	1	Pass	42-48
†11A 15216	Gasket (road lamp)-use with a 5.13" diameter lamp	1	(Pass 1941-48)(Comm, Trucks except COE 1942-45)	41-48
†11A 15217	Wire (road lamp body)-use with 6.35" diameter lamp	1	(Pass 1941-48)(Comm, Trucks 1941-47)	41-48
78 15218-A	Reflector (road lamp)-adjustable focus type	1	Pass	38-39
78 15218-B	Reflector (road lamp)-prefocus type	1	Pass	38-39
01A 15218	Reflector (road lamp)-Unity Design	1	Pass	40-41
11A 15218-B	Reflector (road lamp)-Unity Design-used with a composite bulb lamp	1	Pass	41
78 15219	Screw (road lamp door)	1	Pass	38-40
01A 15220	Bulb (road lamp)-32 CP	1	Pass	40-41
11A 15220-C	Bulb (road lamp)-sealed beam-Amber-use with a 5.25" diameter lamp	1	Pass	42-48
21T 15220-B	Bulb (road lamp)-Amber-use with a 6.35" diameter lamp	1	Comm, Trucks	42-47
78 15222	Shield (road lamp bulb)	1	Pass	38-40
91A 15224	Switch (road lamp)-with 20 amp fuse	1	Pass, Comm, Trucks except COE	39
11A 15224	Switch (road lamp)-with fuse-Unity & Appleton Design	1	Pass	38-41
78 15226	Clamp (road lamp bracket)-upper-Unity Design	1	(Pass 1938-42)(Comm 1938-47)(Trucks 1942-47)	38-47
†51A 15229	Ring assy (road lamp bulb retainer)	1	Pass	46-48

† No Longer Supplied



CHASSIS PARTS CATALOGUE

PART NUMBER	PART NAME	NO. REQ'D	MODEL	YEAR 19
Accessories				
78 15232	Washer (road lamp bracket)	1	Pass	38-40
+51A 15232	Washer (road lamp mounting)-use with 5.25" diameter lamp	1	Pass	46-48
11A 15234-A	Ornament assy (road lamp)-use with a 6.35" diameter lamp	1	(Pass 1941-48)(Comm, Trucks 1941-47)	41-48
11A 15239	Wire (road lamp ground)-use with a 6.35" diameter lamp	1	(Pass 1941-42)(Comm, Trucks 1942-47)	41-47
51A 15239	Wire (road lamp ground)-use with a 5.25" diameter lamp	1	Pass	46-48
+51A 15244	Wire lead assy (road lamp)-RH-use with a 5.25" diameter lamp	1	Pass	46-48
51A 15245	Wire lead assy (road lamp)-LH-use with a 5.25" diameter lamp	1	Pass	46-48
11A 15374	Nut (rim retaining screw)	1	(Pass 1941-48)(Comm, Trucks except COE 1941-47)	41-48
11A 15375	Screw (rim retaining)	1	(Pass 1941-48)(Comm, Trucks except COE 1941-47)	41-48
21A 18160	Kit (road lamp bracket)	1	Pass	42
21T 18160	Kit (road lamp bracket)	1	Comm, Trucks	42-47
51A 18160-B	Kit (road lamp mounting bracket)	1	Pass	46-48
+11A 18207-A3	Kit (road lamp)-consists of two lamps	1	Pass	41-48
21T 18207-A	Kit (road lamp)-consists of two lamps	1	Trucks	41-47
+51A 18207-B	Kit (road lamp & bracket)-consists of two lamps & mounting brackets	1	Pass	41-48
A 18570	Bulb (road lamp)-6-8V-32 CP	1	Pass	38-39

Utility Lamp

51A 13465	Bulb (utility lamp)-15 CP-6 Volt	1	Pass	38-48
51A 15550-B	Lamp assy (utility)-for attaching to cigar lighter socket	1	Pass	38-48

Cigar Lighter

48 15021	Bulb (illuminated cigar lighter)	1	Pass	41-48
51A 7004600-D	Cigar lighter assy (automatic)	1	Pass	46-48
51A 7004610-D	Knob & element assy (automatic cigar lighter)	1	Pass	46-48
6A 7004610-A	Knob & element assy (cigar lighter)	1	Pass-DeLuxe	47-48
6A 7004610-B	Knob & element assy (cigar lighter)	1	Pass-Super DeLuxe	47-48
51A 7004616-A	Element assy (cigar lighter)	1	Pass	46-48
01A 7004620	Socket & retainer assy (cigar lighter)	1	Pass-DeLuxe	40-48
51A 7004620-A	Socket & retainer assy (cigar lighter)	1	Pass-Super DeLuxe	46-48
8C 8104601-B	Cigar lighter assy-illuminated	1	Pass	41-48

Rear Door Safety Lock

51A 18333	Kit (rear door safety lock)	1	Fordor Sedan	35-48
-----------	-----------------------------	---	--------------	-------

Mirror (Outside)

+21A 18402-A	Mirror & bracket assy (rear view)-outside-RH	1	Pass	42-48
11A 18432	Stud (outside rear view mirror)-front	1	Pass	41
	89503-S7 Stud (outside rear view mirror)-rear	1	Pass	41
21A 18403-A	Mirror assy (outside rear view)	1	Pass	42-48

† No Longer Supplied



CHASSIS PARTS CATALOGUE

PART NUMBER	PART NAME	NO. REQ'D	MODEL	YEAR
-------------	-----------	-----------	-------	------

Accessories

Vanity Mirror

21A 18208	Mirror (visor vanity)	1	(Pass 1942-48)(Comm, Trucks 1942-47)	42-48
-----------	-----------------------	---	--------------------------------------	-------

Magnetic Drain Plug

+357983-S	Insert (oil pan drain plug)-magnetic-use with 1GA-6730	1	Pass, Comm, Trucks (6 cyl "G" Series)	41-47
+357991-S	Plug (rear axle drain)-magnetic -1/2" pipe	1	(Pass 1936-48)(Comm 1936-47)	36-48
+357993-S	Plug (transmissions drain)-magnetic	1	(Pass 1928-48 except 60 HP 1937-39) (Comm 1928-47)(122" 3/4 Ton 1939-47) (122" 1 Ton 1938-47)(Trucks 1 1/2 Ton & greater 1928-47)	28-48
+357994-S	Plug (oil pan drain)-magnetic-1-1/2" -20	1	Pass, Comm, Trucks-60 HP (8 cyl)	38-40
		1	Pass-90 & 100 HP (8 cyl)	39-48
		1	Comm, Trucks-90 & 100 HP (8 cyl)	39-47

Radio

8A 14526	Fuse (radio)-14 amp	1	Pass	46-48
+51A 18800-A	Radio assy-complete with antenna-closed cars	1	Pass	46-48
+51A 18800-B	Radio assy-complete with antenna-open cars	1	Pass	46-48
+51A 18800-D	Radio assy-complete with antenna	1	Pass	46-48
+51A 18813-A	Antenna (radio)-closed cars-mounted on roof	1	Pass	46-48
+51A 18813-B	Antenna (radio)-open car-mounted on cowl side	1	Pass	46-48
51A 18813-C	Antenna (radio)-mounted on right side of cowl	1	Pass	42-48
51A 18875	Speaker assy (rear seat)	1	Pass except Convertibles, Station Wagon, Sportsman Coupe	46-48
APA 18875	Speaker kit (radio rear seat)-contains-2 speakers in a display carton	1	Pass except Station Wagon & Convertibles	46-48
91A 18892	Bracket (antenna control)	1	Station Wagon	39
	30031-S7 Screw (antenna control bracket)	1	Station Wagon	39

Radiator Grille Insect Screen

51A 8198	Kit (radiator grille insect screen)	1	Pass	46-48
----------	-------------------------------------	---	------	-------

Seat Covers

11A 18625	Seat covers-universal	1	Ford-Tudor & 5 Pass Coupe	41-48
51A 18625-D	Seat covers (set)-gabardine-Maroon, Blue, Steel	1	Fordor Sedan	46-48
11A 18628	Seat covers-universal	1	Ford-Fordor	41-48

Rear Fender Shield

11A 18956	Lever (rear fender shield)-RH	1	Pass	41
11A 18957	Lever (rear fender shield)-LH	1	Pass	41
01A 18977	Bracket (fender shield adjusting)-RH	1	(Pass, Comm 1940)(Comm 1941)	40-41
01A 18978	Bracket (fender shield adjusting)-LH	1	(Pass, Comm 1940)(Comm 1941)	40-41
11A 18978	Bracket (rear fender shield)-RH	1	Pass	41-48
11A 18979	Bracket (rear fender shield)-LH	1	Pass	41-48
78 18982	Anti-rattler	1	(Pass 1937-39)(Comm 1938-39)(Comm 1941)	37-41
11A 18983	Bracket (rear fender shield)-upper half	1	Pass	41-48
	355115-S7 No.10-32 x 7/16" carriage bolt	2	Pass	41-48
	78-16336 Bolt & collar (fender shield)	1	Pass	37-41
11A 18989	Bracket (rear fender shield)-lower half	1	Pass	41-48
21A 18990-A	Seal (rear fender shield)-rubber-RH	1	(Pass 1941-48)(Comm 1940-41)	40-48
11A 18991	Seal (rear fender shield)-rubber-LH	1	Pass	41-42
11A 18998	Plate (rear fender shield swivel)	2	Pass	41
21A 18998	Plate (rear fender shield swivel)	2	Pass	42-48

f No Longer Supplied



CHASSIS PARTS CATALOGUE

PART NUMBER	PART NAME	NO. REQ'D	MODEL	YEAR 19__
Accessories				
Spotlight				
01A 15214-A	Rim (spotlight lens)-6" diameter-Unity Design	1	(Pass 1940-48)(Comm,Trucks except COE 1940-47)	40-48
01A 15218	Reflector (spotlight)-6" diameter-Unity Design	1	Pass	40-48
01A 15220	Bulb (spotlight)-32 CP-Unity & Appleton Design	1	Pass	40-48
78 15222	Shield (spotlight bulb)-use with 01A 15220	1	(Pass 1940-48)(Comm,Trucks 1941-47)	40-48
11A 15234-A	Ornament assy (spotlight)	1	(Pass 1941-48)(Comm,Trucks 1941-47)	41-48
6A 15323	Bracket assy (spotlight)-outside	1	Pass	47-48
†6A 15328	Rim assy (spotlight)-polished	1	Pass	47-48
6A 15330	Bulb assy (spotlight)-sealed beam 4.4" diam.	1	Pass	47-48
8C 15330	Bulb (spotlight)-sealed beam-5.65 diam.-used in 51A 18552-B spotlight	1	(Pass 1941-48)(Comm,Trucks 1941-47)	41-48
51A 15332	Switch (spotlight)	1	(Pass 1946-48)(Comm,Trucks 1946-47)	46-48
6A 15350	Handle assy (spotlight)	1	Pass	47-48
†6A 15362	Handle (spotlight)-lower section	1	Pass	47-48
11A 15374	Nut (spotlight retaining screw)	1	(Pass 1941-48)(Comm,Trucks 1941-47)	41-48
11A 15375	Screw (spotlight rim retaining)	1	(Pass 1941-48)(Comm,Trucks 1941-48)	41-48
51A 18552-B	Spotlight-less brackets	1	(Pass 1941-48)(Comm,Trucks 1941-47)	41-48
†6A 18552-B	Spotlight assy-with bracket	1	Pass	46-48
48 18565-A	Lens (spotlight)-6" diameter	1	(Pass 1935)(Pass 1940-48)(Comm,Trucks 1941-47)	35-48
48 18565-B	Lens (spotlight)-5 1/2" diameter-Unity & Appleton	1	Pass	35-42
48 18566-A	Gasket (spotlight lens)-6" diameter	1	(Pass 1935)(Pass 1940-48)(Comm,Trucks 1941-47)	35-48
48 18568-B	Reflector (spotlight lens)-5 1/2" diameter	1	Pass	35-39
48 18569-B	Ring (spotlight lens)-5 1/2" diameter	1	Pass	35-39
A 18570	Bulb (spotlight)-32 CP	1	Pass, Comm	31
01C 18573	Bracket set (spotlight)-RH-Unity Design-plated-use with 51A 18552-B	1	Comm,Trucks except COE	38-47
01W 18573	Bracket set (spotlight)-RH-Unity Design-plated-use with 51A 18552-B	1	COE	40-47
†11A 18573-B	Bracket set (spotlight)-RH-Unity Design-plated	1	Pass	41-48
48 18574	Brackets (spotlight inside & outside)-with screws, instruction sheet & template	1	(Convertibles 1935-39)(Station Wagons 1935-38)	35-39
01C 18574	Bracket (spotlight)-LH-plated-use with 51A 18552-B	1	Comm,Trucks except COE	38-47
01W 18574	Bracket (spotlight)-LH-polished-use with 51A 18552-B	1	COE	40-47
11A 18574-B	Bracket (spotlight)-LH-Unity Design-polished-use with 51A 18552-B	1	Pass	41-48
11A 18576-B	Handle & switch assy (spotlight)	1	Pass	41-48
†68 18578	Lever (spotlight switch operating)	1	Pass	38-40
†68 18579	Contact (spotlight switch)	1	Pass	38-40

† No Longer Supplied



CHASSIS PARTS CATALOGUE

PART NUMBER	PART NAME	NO. REQ'D	MODEL	YEAR 19__
-------------	-----------	-----------	-------	--------------

Accessories

Turn Indicator

6A 18440	Turn indicator-complete Kit for installation	1	Pass	42-48
0A 13234-B	Socket & wiring assy (turn indicator & parking lamp)	2	Pass	42-48
0A 13305	Lever (turn indicator case)	1	Pass	42-48
6A 13338	Case assy (turn indicator)-less lever-on steering column	1	Pass	42-48
8L 13350-B	Flasher assy (turn indicator)-plug in type	1	Pass	42-48
8L 13351	Clamp (turn indicator flasher)	1	Pass	42-48
11A 13465	Bulb (turn indicator & parking lamp)-21-3 CP 6 volt	2	Pass	42-48
01C 13583	Shield (turn indicator light jewel)	2	Pass	42-48
01C 13586	Jewel (turn indicator light shield)	2	Pass	42-48
B 14487	Connector & sleeve assy (front turn indicator wiring terminals)	2 2	Pass Pass	42-48 42-48
0A 14492	Switch & wiring assy (turn indicator) less flasher, clamp & bulb	1	Pass	42-48
0A 14499	Wiring assy (front turn indicator & parking lamp to splice)	1	Pass	42-48
8M 14526	Fuse (turn indicator wiring)-15 amp	1	Pass	42-48
6A 14561	Wiring assy (turn indicator switch to stop light switch)	1	Pass	42-48
8A 14572-B	Clamp (turn indicator wiring to steering column tube)	3	Pass	42-48
48 15021	Bulb (turn indicator)-1 CP-8 volt	2	Pass	42-48

Sun Visor

8A 18236-B	Visor (sun)-outside	1	Pass	41-48
+6A 18652	Visor assy (sun)-polarized-inside	1	Pass	46-48

Accessories

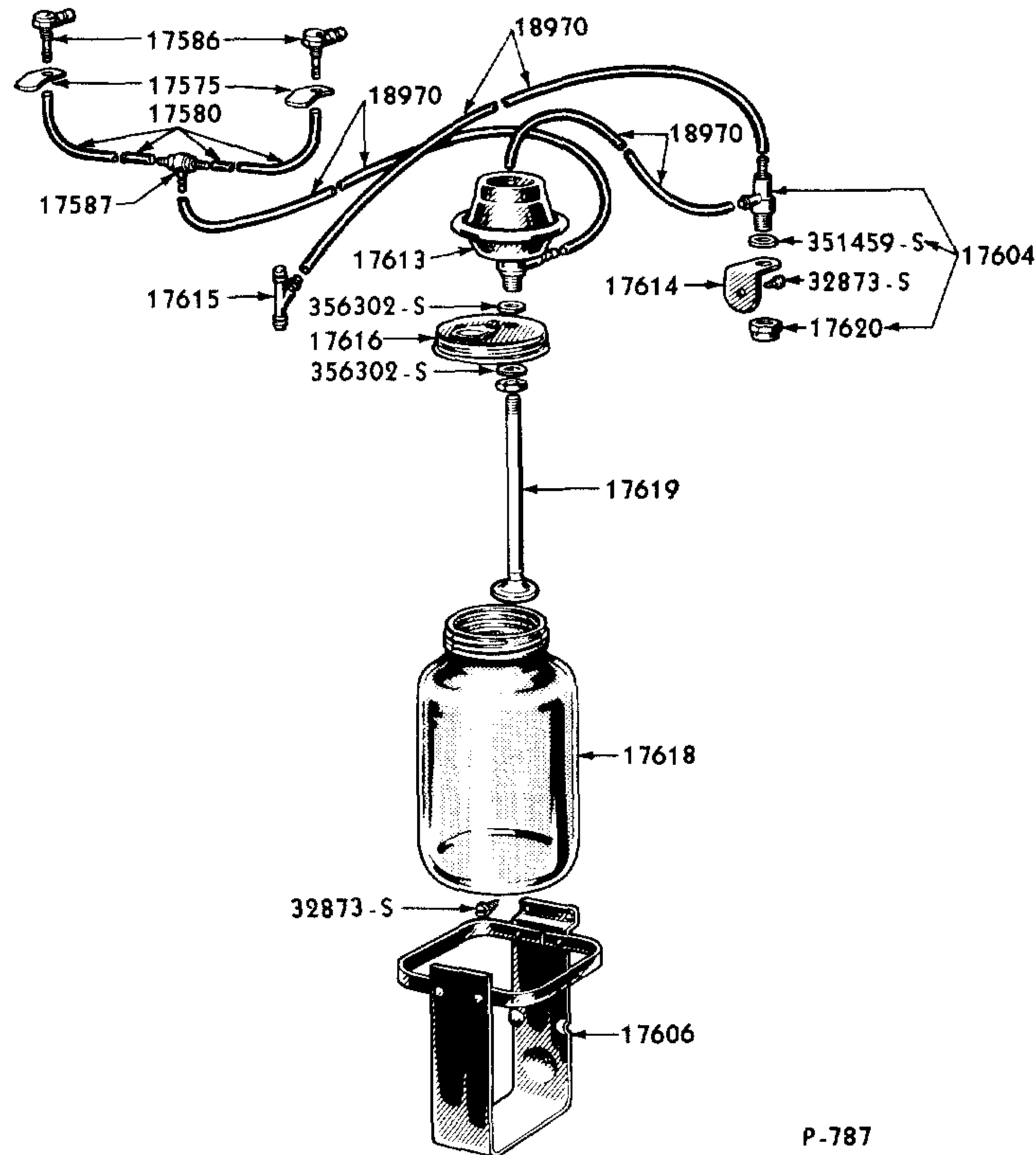

P-787

WINDSHIELD WASHER

Basic numbers only shown on illustration. Order by Part Numbers shown in list of parts.

PART NUMBER	PART NAME	NO. REQ'D	MODEL	YEAR
-------------	-----------	-----------	-------	------

Accessories**Windshield Washer**

51A 17575	Wing nut (nozzle assy)-5/16"-32	2	Pass	42-48
+51A 17580	Hose (tee to nozzle assy)-1/8" I.D. x 18" long	2	Pass	42-48
51A 17586	Nozzle assy (windshield washer)	2	Pass	42-48
8A 17586-A	Nozzle assy (windshield washer)-on center cowl-foot control type washer	1	Pass	40-48
	356302-S Washer (nozzle assy)-on cowl-rubber-5/16" x 3/32"	2	Pass	42-48
51A 17587	Tee assy (windshield washer hose)	1	Pass	42-48
51A 17604	Control assy (windshield washer)-dash	1	Pass	42-48
	351459-S2 Washer(w/shield washer con.)-1/2"	1	Pass	42-48
8A 17604	Control assy (windshield washer)-foot operated	1	Pass	42-48
51A 17606-B	Bracket & strap assy (windshield washer to jar)	1	Pass	42-48
51A 17613	Body assy (windshield washer pump)	1	Pass	42-48
51A 17614	Bracket (windshield washer control mounting)	1	Pass	42-48
51A 17615	Connection (windshield wiper hose to dash control assy)-tee-1/4" x 1/4" x 3/16"	1	Pass	42-48
51A 17616	Cover assy (windshield washer jar)	1	Pass	42-48
51A 17618	Jar (windshield washer)	1	Pass	42-48
51A 17619	Tube (windshield washer strainer)	1	Pass	42-48
51A 17620	Nut (windshield washer holding)	1	Pass	42-48
51A 18293	Kit (windshield washer)-automatic	1	Pass	42-48
8A 18293-A	Washer kit (windshield-foot control type)	1	Pass	42-48
0A 18293	Washer kit(w/shield)-ft.control type nozzle mtd.on cowl	1	Pass	28-48
8A 19550	Solution (windshield washer)	1	Pass	42-48

† No Longer Supplied

Accessories

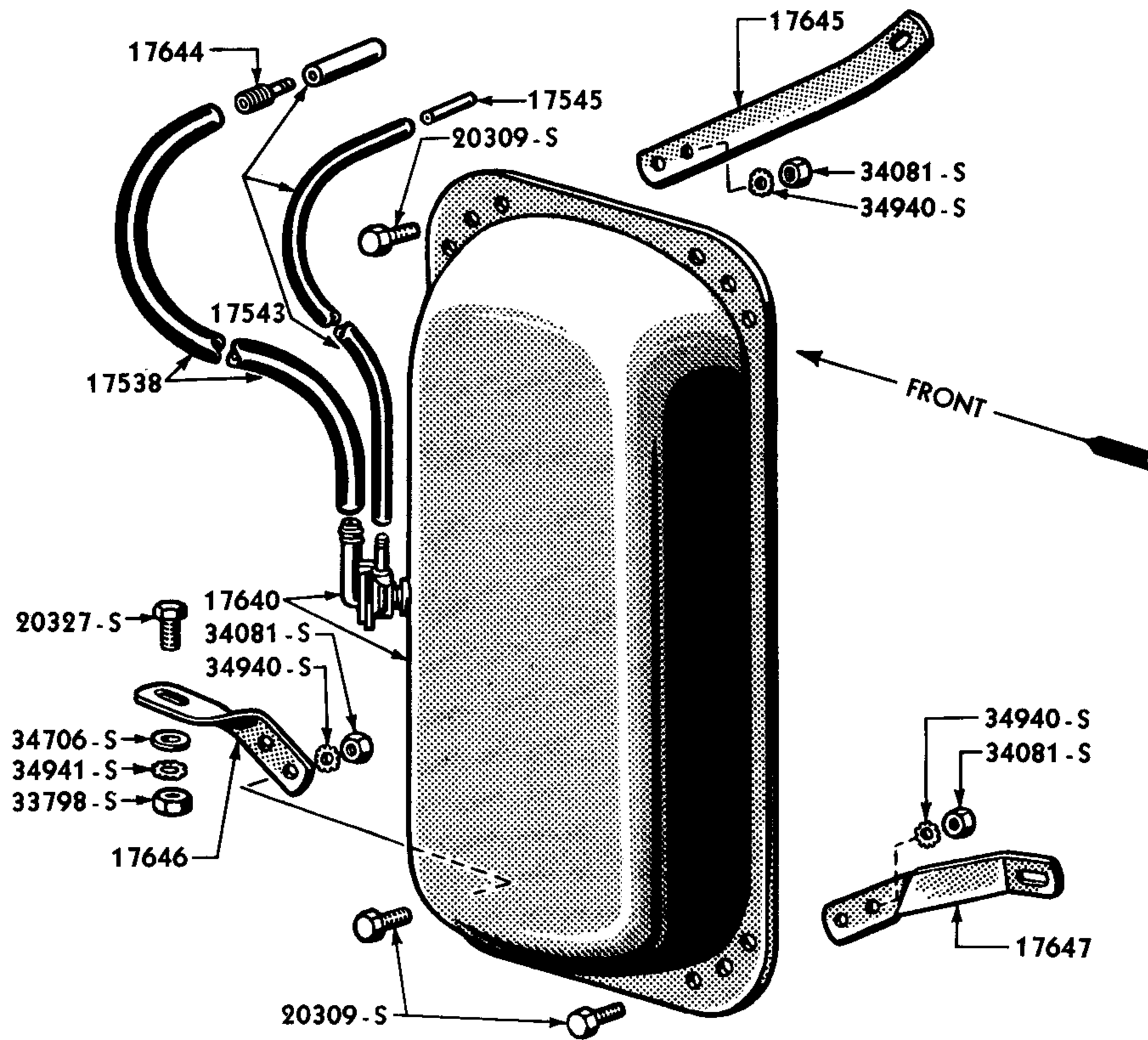

P-789

WINDSHIELD WIPER VACUUM TANK

Basic numbers only shown on illustration. Order by Part Numbers shown in list of parts.

PART NUMBER	PART NAME	NO. REQ'D	MODEL	YEAR 19__
-------------	-----------	-----------	-------	--------------

Accessories

Windshield Wiper Vacuum Tank

51A 17538	Tube (carburetor to vacuum tube)-40" long	As Reqd	Pass	42-48
†51A 17545	Connector (vacuum tank to windshield wiper tube)	1	Pass	42-48
†51A 17639	Kit (windshield wiper vacuum storage tank)	1	Pass	42-48
51A 17640	Tank assy (windshield wiper vacuum)	1	Pass	42-48
51A 17644	Connector (windshield wiper adapter)-on carburetor	1	Pass	42-48
51A 17645	Bracket (windshield wiper vacuum tank)-upper	1	Pass	42-48
	20309-S2 Screw (bracket to tank)	2	Pass	42-48
	34081-S7 Nut (bracket to tank)	2	Pass	42-48
	34940-S2 Lockwasher (bracket to tank)	2	Pass	42-48
51A 17646	Bracket (windshield wiper vacuum tank to fender)	1	Pass	42-48
	20309-S2 Screw (bracket to tank)	2	Pass	42-48
	34940-S2 Lockwasher (bracket to tank)	2	Pass	42-48
	34081-S7 Nut (bracket to tank)	2	Pass	42-48
	20327-S2 Bolt (bracket to fender)	1	Pass	42-48
	33798-S2 Nut (bracket to fender)	1	Pass	42-48
	34941-S2 Washer (bracket to fender)	1	Pass	42-48
	34706-S2 Washer (bracket to fender)-5/16"	1	Pass	42-48
51A 17647	Bracket (windshield wiper tank to body)	1	Pass	42-48
	20309-S2 Screw (bracket to tank)	2	Pass	42-48
	34940-S7 Lockwasher (bracket to tank)	2	Pass	42-48
	34081-S7 Nut (bracket to tank)	2	Pass	42-48

† No Longer Supplied



CHASSIS PARTS CATALOGUE

PART NUMBER	PART NAME	NO. REQ'D	MODEL	YEAR 19__
Oil Filter				
7HA 6731-A	Cartridge (oil filter)-with gaskets-formerly 01A-18662-A	1	(Pass 1938-48)(Comm, Trucks except COE 1938-47)	38-49
01A 6746	Gasket (engine oil filter cover)-formerly 01A-18689	1	(Pass 1938-48)(Comm, Trucks 1938-47)	38-48
01A 6885	Gasket (engine oil filter)-formerly 01A-18688-A	1	(Pass 1938-48)(Comm, Trucks 1938-47)	38-48
11W 18637-B	Tube (oil filter return)	1	COE	41-47
	91A-2133 Nut (oil filter tube)	4	(Pass 1939-48)(Comm, Trucks 1939-47) (8 cyl)	39-48
59W 18637	Tube assy (oil filter outlet to oil pan)-use with 11W-18641	1	COE	46-47
11W 18638	Hose (oil filter oil return)-distributor end-for 11W-18658-B	1	COE	41
11W 18639	Clamp (oil filter inlet to outlet hose)	1	COE	41-47
11W 18641	Line (oil filter outlet)-flexible-used with 59W-18637	1	COE	41-47
f11W 18642	Washer (oil filter return stud)	1	COE	41
11W 18643	Clamp (oil filter return hose)-distributor end	1	COE	41
01A 18658-A	Filter assy (oil)-service 11A-18658-A	1	90 & 100 HP except COE (8 cyl)	38-40
11A 18658-A	Filter assy (oil)-installation kit	1	90 & 100 HP except COE (8 cyl)	38-46
	350710-S7 Nut (oil filter to cylinder head)-7/16"-20	3	90 & 100 HP except COE (8 cyl)	38-47
11W 18658-B	Filter assy (oil)-installation kit-except with oil pans having 59A-6751	1	COE	38-47
	353054-S Plug (pipe)	1	90 & 100 HP except COE	38-48
1GA 18658-A	Filter assy (oil)-Fram	1	(6 cyl "G" Series)	41-47
1NC 18660	Filter assy (oil)	1	(4 cyl)	41-42
59A 18660-A	Filter assy (oil)-use with oil pan having 59A-6751	1	(Pass 1940-48)(Comm, Trucks except COE 1940-47)(8 cyl)	40-48
	351428-S7 Washer (oil filter bracket to cylinder head)	4	(4 cyl)	41-42
59W 18660	Filter assy (oil)-use with oil pans having 59A-6751	1	COE	46-47
	36824-S2 Bolt (oil filter to bracket)- 1/4"-20 x 1/2"	2		46-47
	34129-S2 Nut-1/4"-20			
	34805-S2 Lockwasher-1/4"			
74 18661	Bolt (return)	1	60 HP	38-39
01A 18661-B	Stud (oil filter)-hollow-at distributor	1	90 & 100 HP also COE (8 cyl)	40-41
51 18662-B	Cartridge (oil filter)-AC Design	1	60, 90 & 100 HP	35-40
01A 18662-A	Cartridge (oil filter)-part of 01A-18658-A, 11A-18658-A, 1GA-18658-A-Fram Design-replaced by 7HA-6731-A	1	90 & 100 HP-except COE	38-48
11W 18662	Cartridge (oil filter)	1	COE	38-47
9N 18662	Cartridge (oil filter)	1	(4 cyl)	41-42
51 18664	Band (oil filter mounting)	1	60, 90 & 100 HP	35-40
74 18665	Bracket (oil filter mounting)	1	60 HP	37-39
81T 18665	Bracket (oil filter mounting)	1	90 & 100 HP	35-39
	20326-S7 Bolt (oil filter bracket to oil filter)	1	COE	41
	20348-S7 Bolt (oil filter to block)	1	(4 cyl)	41

† No Longer Supplied



CHASSIS PARTS CATALOGUE

PART NUMBER	PART NAME	NO. REQ'D	MODEL	YEAR 19__
51 18666-A	Tube (oil filter)-15" long	2	60,90 & 100 HP	35-40
9N 18666	Pipe (oil filter)-short	1	(4 cyl)	41-42
11A 18666	Tube (oil filter outlet)-17.88" long	1	90 & 100 HP except COE (8 cyl)	41-48
1GA 18666	Tube (oil filter outlet)-9.12" long	1	(6 cyl)	41-47
74 18667-A	Tube (oil filter inlet)-17" long	1	60 HP	37-39
74 18667-B	Tube (oil filter)-12" long	1	60 HP, COE	37-39
01A 18667-B	Tube (oil filter inlet)-21" long-for 01A-18658-A	1	90 & 100 HP except COE (8 cyl)	40-41
11A 18667	Tube (oil filter inlet)-22.88" long-for 11A-18658-A	1	90 & 100 HP except COE (8 cyl)	38-47
11W 18667	Tube (oil filter inlet)-flywheel housing to filter	1	COE	41-47
1NC 18667	Pipe (oil filter)-long	1	(4 cyl)	41-42
1GA 18667-B	Tube (oil filter inlet)	1	(6 cyl)	41-47
51 18668	Elbow (oil filter tubing)-90°-1/8" taper pipe & 3/8"-24	1	60,90 & 100 HP	35-40
01A 18668-A	Elbow (outlet pipe)	1	For 01A-18658	40-41
1NC 18668-B	Elbow (oil filter inlet tube to flywheel housing)	1	(4 cyl)	41-42
51 18669-B	Elbow (oil filter inlet tube to flywheel housing)	1	90 & 100 HP	35-40
01A 18669	Elbow (oil filter inlet tube to flywheel housing)- 1/4" x 1/8" pipe thread	1		40-41
0NY 18669	Tee (oil pressure gauge)	1	(4 cyl)	41
1NC 18669	Tee (oil gauge)	1	(4 cyl)	41-42
11A 18669	Elbow-90°-on flywheel housing-for 01A-18658-A	1	90 & 100 HP except COE (8 cyl)	41-42
	355948-S Nut-5/16"-18 special round- copper	1	90 & 100 HP except COE (8 cyl)	41-42
51 18670	Connection (oil filter outlet tube to fuel pump)	1	60,90 & 100 HP	35-40
	26515-S2 Bolt (connection tube)	1	90 & 100 HP	35-40
	34108-S2 Nut (connection tube)	1	90 & 100 HP	35-40
	34805-S2 Washer (connection tube)	1	90 & 100 HP	35-40
01A 18671	Kit (oil filter service)	1	90 & 100 HP	40
74 18672	Connector (inlet tube to oil filter cartridge)	1	60 HP	37-39
74 18673	Gasket (fuel pump to mounting boss)-use only with oil filter	1	60 HP	37-39
74 18674-A	Fitting (oil filter return)	1	60 HP	40-41
01A 18674	Grommet (oil filter)-for 01A-18658-A	1	90 & 100 HP except COE (8 cyl)	40-41
74 18675	Gasket (return bolt)	2	60 HP	38-39
†01A 18675	Gasket (cover cap screw)-for 01A-18658-A 11W-18658-B,11A-18658-A,1GA-18658-A,1NC-18660	1	(4 cyl)(6 cyl)(8 cyl)	40-47
9N 18679	Adaptor (oil filter outlet)-to engine	1	(4 cyl)(6 cyl)(8 cyl)	41-47
59A 18679	Adaptor (oil filter tube)-use with 59A-18660-A & 59W-18660	1	Pass,Comm,Trucks (8 cyl)	46-47
01A 18683	Tube & clamp assy (oil filter outlet)-in carton	1	Pass,Comm,Trucks	40-41
9N 18686	Elbow (oil filter inlet)-on block	1	(4 cyl)(6 cyl)	41-47
01A 18687-A	Cover (oil filter)-for 01A-18658-A,11W-18658-B, 1GA-18658-A,11A-18658-A	1	(6 cyl)(8 cyl)	40-47
9N 18688	Gasket (oil filter cover)	1	(4 cyl)	41-42
01A 18688-A	Gasket (oil filter cover)-for 01A-18658-A, 11W-18658-B,1GA-18658-A,11A-18658-A-replaced by 01A-6885	1	(6 cyl)(8 cyl)	40-47
01A 18689	Gasket (oil filter element)-cork-for 01A-18658-A, 11W-18658-B,11A-18658,1GA-18658-A,1NC-18658- replaced by 01A-6746	1	(4 cyl)(6 cyl)(8 cyl)	40-47
1GA 18690	Clamp (oil filter inlet tube)	1	(6 cyl)	41-47
01A 18691-A	Screw (oil filter cover)-for 01A-18658-A, 11A-18658-A,1GA-18658-A,1NC-18660	1	(6 cyl)(8 cyl)(4 cyl)	40-47
01A 18691-B	Screw (oil filter cover)	1	(6 cyl)(8 cyl)	41-47
01A 18692	Clamp assy (oil filter inlet hose)-for 01A-18658-A	1	90 & 100 HP except COE (8 cyl)	40-41
01A 18693-A	Clamp assy (oil filter outlet hose)-for 01A-18658-A	1	90 & 100 HP except COE (8 cyl)	40-41
11W 18695	Clamp (oil filter return tube to oil pan)	2	COE	41-47

† No Longer Supplied

Accessories

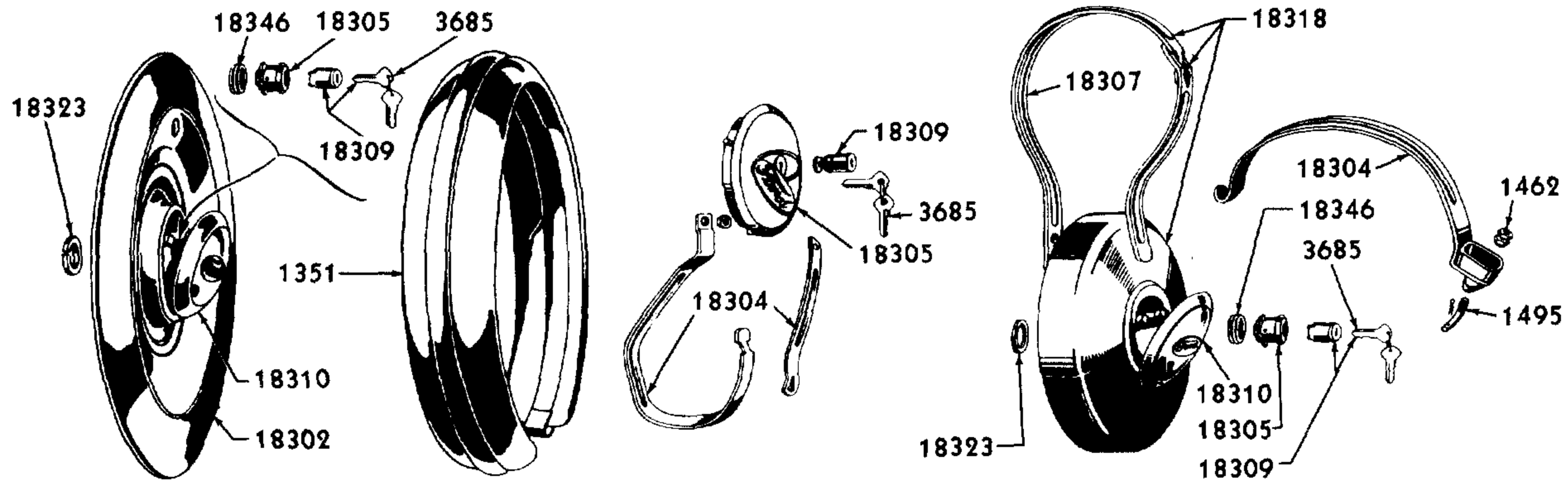

P-197

SPARE WHEEL COVERS AND LOCKS

Basic numbers only shown on illustration. Order by Part Numbers shown in list of parts.

PART NUMBER	PART NAME	NO. REQ'D	MODEL	YEAR 19__
Spare Wheel Lock				
†67 18302-B	Cover & locking drum (spare wheel)-16 x 6.50 tire	1	(Comm 1936-37)(Sedan Delivery, 112" Panel Delivery 1936-38)	36-38
†91C 18302	Cover & locking drum (spare wheel & tire)-center	1	112" Panel Delivery	39
†68 18304-A	Band assy (spare wheel & tire lock)	1	(Convertible Sedan with Trunk)(Comm with Panel Delivery & Pickup Body)	35
78 18304-A	Band assy (spare wheel & tire lock)-for 5.50 x 16 & 6.00 x 16 tire	1	Phaeton, Convertible Sedan	37
78 18304-C	Bands (spare wheel & tire lock)-5.50 & 6.00 x 16	1	5 Window Coupe	37-39
78 18304-D	Bands (spare wheel & tire lock)-6.50 x 16 & 6.00 x 18 tires	1	5 Window Coupe	37-39
50 18305-A	Lock assy (spare wheel & tire)-specify Hurd or Briggs-Stratton	1	Comm	35
	351051-S7 Nut (spare wheel lock band to bracket)	1	Pass, Comm (except Comm 1935)	33-35
	27075-S7 Screw (band to bracket)	1	Pass, Comm	33-35
	34903-S7 Lockwasher (band to bracket)	1	Pass, Comm	35
	351309-S2 Lockwasher (band to bracket)	1	(Convertible Sedan with trunk)(Comm with Panel Delivery & Pickup Body)	35
	89924-S7 Screw-headless set-5/16"-24 x 3/8"	1	Pass, Comm	32-36
67 18305-A	Lock & adapter assy (spare wheel & tire cover)-less lock barrel-use with 6.50 x 16 tire	1	Pass, Comm	36
67 18305-A	Lock (spare wheel)-for 16 x 6.50 tires-less lock barrel	1	Sedan Delivery, 112" Panel Delivery	38
68 18305-A	Lock & adapter assy (spare wheel & tire cover)-less lock barrel	1	(Pass, Comm 1936)(Sedan Delivery, Station Wagon 1937)	36-37
	91A-3658 Key (spare wheel & tire lock)-specify key number	1	(Pass 1932-36)(Comm 1932-35)	32-36
68 18305-A	Lock & adapter (spare wheel & tire cover)-for 16 x 6.00 tires-less lock barrel	1	(Sedan Delivery, Station Wagon 1937-38) (Comm except Platform, Panel Delivery, Sedan Delivery 1938-39)	37-39

† No Longer Supplied



CHASSIS PARTS CATALOGUE

PART NUMBER	PART NAME	NO. REQ'D	MODEL	YEAR
68 18305-B	Lock assy (spare wheel & tire cover)-for 5.50 x 16 tires-standard types	1	Pass, Comm	36
†68 18307-A	Band (spare wheel & tire lock)	1	Pass except Convertible Sedan	36
	23356-S7 Bolt (spare wheel & tire lock band to wheel carrier)	2	(Pass 1936)(Comm except Platform & Panel Delivery)	36-37
	33795-S7 Nut (spare wheel & tire lock band to wheel carrier)	2	(Pass 1936)(Comm 1937)	36-37
	34805-S2 Washer (spare wheel & tire lock band to wheel carrier)	2	(Pass 1936)(Comm 1937)	36-37
	34807-S2 Lockwasher (spare wheel lock band assy to floor pan)	1	Pass	37
01A 18306	Key (luggage compartment, glove compartment & spare tire)-blank	2	Pass	40-48
§§91C 18307	Band (spare wheel lock)-long-rear	1	112" Pickup	39
01C 18307	Band (tire lock)-long-rear	1	Comm except Panel Delivery & Pickup	40-47
68 18308	Band (spare wheel & tire lock)-short	1	Convertible Sedan with Trunk	36
†§§91C 18308	Band (spare wheel lock)-short-front	1	112" Pickup	39
	351051-S7 Nut (spare wheel lock band)-check	1	112" Pickup	39-41
01C 18308	Band (tire lock)-short-front-use with 6.00 x 16 & 6.50 x 16 tires	1	Comm except Platform & Panel Delivery	40-47
48 18309-B	Band (spare wheel & lock)	1	Pass, Comm	35
48 18309-C	Band (spare wheel & lock)	1	(Pass 1933-35)(Comm 1935)	35
◇68 18309-A	Cylinder (spare wheel & tire lock)-with keys	1	(Sedan Delivery, Station Wagon 1936-37) (Panel Delivery, Pickup 1938-39)	36-39
	350331-S7 Screw (lock cylinder)-1/4"-28 x overall length .42"-slotted head	1	(Pass, Comm 1936-37)(Comm except Panel Delivery, Pickup, Sedan Delivery, Station Wagon 1938-39)	36-39
01A 18309-A	Cylinder (spare wheel lock)-with 2 Keys	1	(Pass 1939)(Comm with Panel Delivery & Pickup 1945-47)	39-47
†91C 18310	Cap (spare wheel and tire cover)	1	(Pass except Sedan Delivery, Station Wagon with trunk, Comm 1936)(Panel Delivery 1937-39)(Sedan Delivery 1937-38)(Station Wagon 1937)	36-39
01A 18312-A	Lock assy (spare wheel & tire)-2 keys	1	(Pass 1936-48)(Comm 1936-47)	36-48
01A 18312-A	Lock assy (spare wheel & tire)-2 keys	1	Station Wagon	46-48
40 18313	Cover (spare wheel & tire lock cyl)	1	Pass	33-34
A 18317-C	Nut (wheel carrier lock)	1	131 1/2" Panel Delivery, Express	28-29
	351051-S7 Nut (spare wheel & tire lock check)	3	Pass, Comm	28-29
68 18318-A	Lock & band assy (spare wheel & tire)-use without wheel cover	1	Pass	36
91C 18318	Lock assy (spare wheel & tire)	1	Comm	39
	33795-S7 Nut	1	(Pass 1936)(Comm 1937)	36-37
	34805-S2 Lockwasher	1	(Pass 1936)(Comm 1937)	36-37
†48 18320	Spring (spare wheel tire lock)-use with 01A-18312-A 48-18328-B & 01A-18312	1	(Pass 1938-48)(Comm 1938-47)	38-48
†68 18323	Retainer (spare wheel tire cover lock sleeve)	1	Pass, Comm	36
B 18325	Filler (spare wheel & tire cover lock)	1	Pass, Comm	32
48 18328-B	Body (spare wheel lock)	1	(Pass 1937-39)(Panel Delivery, Pickup 1939)(Station Wagon 1940-48)(Panel, Pickup 1946-48)	37-48
68 18340	Hinge assy (spare wheel cover cap)	1	Pass, Comm	36
68 18340	Hinge (spare wheel cover cap)	1	Sedan Delivery, 114" Panel Delivery	38
A 18345-B	Nut (spare wheel lock)	1	Pass, Comm	28-29
†AA 18345	Nut (spare wheel lock)	1	Trucks	29-31

§§ Used with wheel carrier assembled to body.

† No Longer Supplied

◇ A1 Hurd design, A2 Briggs Stratton design.



CHASSIS PARTS CATALOGUE

PART NUMBER	PART NAME	NO. REQ'D	MODEL	YEAR
				19__
†68 18346	Spring (spare wheel cover lock sleeve)	1	Pass, Comm with Closed Cab & Panel Delivery	36
†68 18346	Spring (spare wheel cover lock sleeve)	1	Comm except Platform & Panel Delivery	39
	355836-S7 Nut (tire moulding retainer washer)-use with 5.50 x 16 cover	1	Pass, Comm	36
	34902-S Washer (tire moulding retainer)-use with 5.50 x 16 cover	1	Pass, Comm	36
	350153-S7 Screw (tire moulding retainer washer)-use with 5.50 x 16 cover	1	Pass, Comm	36
†78 18356-A	Spring (spare wheel tension)	1	Tudor, Fordor	37
	63397-S Rivet (spare wheel tension spring to luggage compartment shelf board bottom)	3	Pass	37

Ash Receptacle

78 18950-B	Receptacle assy (quarter ash)-Walnut Grain Finish	1	Pass	37
81C 18950	Receptacle (ash)	1	Comm	38-39
†78 18956-A	Retainer assy (quarter ash receptacle)-Mahogany Finish	1	Pass	37

Windshield Wings

†B 18254	Bracket assy (windshield wing)-RH	2	(Pass 1930-31)(Roadster, Phaeton 1933-34)	30-34
78 18258	Glass (windshield wings)	2	Roadster, Phaeton	37-38
	350454-S13 Screw (windshield wing support)-upper	2	Roadster, Phaeton	35-36
†78 18284	Support (windshield wings bracket)-RH	1	Roadster, Phaeton	37-38
	350642-S13 Screw (windshield wings pivot)-lower	2	Roadster, Phaeton	37
	351034-S13 Nut (windshield wings pivot)-lower	2	Roadster, Phaeton	37
48 18294	Glass assy (draft deflector)	2	Pass except Convertible	35-36
†68 18294	Glass assy (draft deflector)	2	Sedan, Coupe, Sedan Delivery	35-37
	32944-S2 Screw (draft deflector frame to door)	8	Pass	35-37
	34806-S2 Lockwasher (draft deflector frame to door)	8	Pass	35-37
	72000-S7 Cotter pin (draft deflector frame to door)	2	Pass	35-37
	350805-S Nut (draft deflector frame to door)	2	Pass	35-37
	34029-S2 Nut (draft deflector)	2	Pass	35-37

Warning and Clearance Lamp

†§BB 18702-A	Lamp & bracket (warning)-Green lens-3 lamp cluster	1	Trucks	31-47
†§BB 18702-B	Lamp & bracket (warning)-Red lens-3 lamp cluster	1	Trucks	31-47
	34827-S2 Lockwasher (lamp to bracket)	2	Trucks	31-47
	34707-S2 Washer (lamp to bracket)	2	Trucks	31-47
	33795-S7 Nut	1	Trucks	32-37
	34705-S2 Washer	1	Trucks	32-37
	34805-S2 Lockwasher	1	Trucks	32-37
BB 18735-A	Lens (clearance lamp)-White	1	Trucks	31-47
BB 18735-B	Lens (clearance lamp)-Yellow	1	Trucks	31-47
BB 18735-C	Lens (clearance lamp)-Red	1	Trucks	31-47
BB 18735-D	Lens (clearance lamp)-Green	1	Trucks	31-47
BB 18735-E	Lens (clearance lamp)-Blue	1	Trucks	31-47
BB 18737	Retainer (clearance lamp lens)	1	Trucks	31-47

§ Front for Illinois only. ◊ Rear for Illinois only. † No Longer Supplied



CHASSIS PARTS CATALOGUE

PART NUMBER	CONSISTS OF			No. REQ'D	MODEL	YEAR 19__
-------------	-------------	--	--	-----------	-------	-----------

Miscellaneous Kits

SPARE WHEEL CARRIER KIT

78T 1459	1-11U 1410 Carrier 2-11U 1432 Arm 2- 51 1437 Bolt	2- 51 1466 Bolt 2- 51 1476-A Nut 4- 24429-S7 Bolt 2- 351059-S8 Nut	4- 33800-S8 Nut 4- 34847-S8 Lockwasher 2- 72035-S7 C/Pin	1	Trucks	42-47
----------	---	---	--	---	--------	-------

BRAKE MASTER CYLINDER REPAIR KIT

91A 2004-B	1-91A 2151 Gasket 1-91A 2152 Gasket 1-91A 2167 Gasket	1-91A 2169-A Piston 1-91A 2173-A Cup 1-91A 2174 Snap ring	1-91A 2178 Valve 1-91A 2180-A Boot 1-91A 2188 Plate	1	(Pass 1939-48)(Comm 1939-47)	39-48
91T 2004-A		1-91T 2169 Piston 1-91T 2173-A Cup 1-91T 2180-A Boot	1-91T 2178 Valve	1	Trucks	39-47
91T 2004-B	1-91A 2151 Gasket 1-91A 2152 Gasket 1-91A 2167 Gasket 1-91T 2169 Piston	1-91T 2173-A Cup 1-91T 2174 Ring 1-91T 2178 Valve 1-91T 2180-A Boot	1-91T 2186 Strap 1-91T 2187 Strap 1-91T 2188 Plate	1	Trucks	47

BRAKE LINING KIT

48 2007-C	8- 48 2021 Lining	88- Rivets		1	(Pass-front & rear 1935-36)(Comm-front & rear 1935-38)(122" Ton Truck-front 1938)	35-38
78 2007-C	8- 78 2021 Lining	88- 351915-AS Rivets		1	Pass	37-38
91A 2007-C	4-01A 2021 Lining	4-01A 2022 Lining	74- 351915-AS Rivets	2	Pass	39-48

BRAKE WHEEL CYLINDER REPAIR KIT

91A 2128	1-91A 2201 Cup	1-91A 2202 Cup	2-91A 2206-A Boot	2	(Pass 1939-48)(Comm 1939-47)	39-48
91T 2128	2-91T 2201 Cup	2-91T 2206-A Boot		2	Trucks except 122"	39-47
91A 2221	1-91A 2201 Cup	1-91A 2203 Cup 1-91A 2207-A Boot	1-91A 2206-A Boot	2or4	(Pass,Comm,122"1 ton truck-front)(122"3/4 ton truck-front & rear)	39-41
91T 2221	2-92Y 2201 Cup	92Y 2206-A Boot		2	(Trucks except 122"-front)(122"1 ton truck-rear)	39-47
21A 2221	1-91A 2201 Cup	1-92Y 2201 Cup 2-91A 2207-A Boot	1-91A 2206-A Boot	2or4	(Pass 1942-48)(Comm, 122"1 ton truck-front-1942-47)(122"3/4 ton truck-front & rear-1942-47)	42-48



CHASSIS PARTS CATALOGUE

PART NUMBER	CONSISTS OF						No. Req'd	MODEL	YEAR 19__
BRAKE BOOSTER MAJOR REPAIR KIT									
59T 2309-B	1-59T 2324-B	Diaphragm	1-59T 2382	Gasket	1-59T 2415-B	Retainer	1	Trucks except 122"	45-47
	1-59T 2351	Seal	1-59T 2384-B	Seal	1-59T 2437	Gasket			
	1-59T 2373-B	Gasket	1-59T 2397-A	Seal	1-59T 2438-B	Spring			
	1-59T 2375	Spring	1-59T 2398-B	Retainer	1- 352643-S	Pin			
	1-59T 2378	Retainer	1-59T 2408-B	Cup	1-	Piston			
	1-59T 2380	Gasket	1-59T 2409	Ring	1-	Gasket			
59T 2309-C	1-59T 2308-A	Disc	1-59T 2392-A	Spring	1-59T 2412	Gasket	1	Trucks except 122"	45-47
	1-59T 2368-A	Piston	1-59T 2394-A	Diaphragm	1-59T 2418	Spring			
	1-59T 2373-A	Gasket	1-59T 2399-A	Seal	1-59T 2438-A	Spring			
	1-59T 2384-A	Seal	1-59T 2408-A	Cup	1- 351598-S	Gasket			
	1-	Plunger	1-	Diaphragm	1-	Seal			
	1-	Hose	1-	Washer					
SPINDLE BOLT AND BUSHING KIT									
A 3111	4-11A 3110-A	Bushing	2- B 3121	Felt	2- B 3124-A	Nut	1	Pass & Comm	28-31
	1- A 3115-C	Bolt	2- B 3122	Pin	2- B 3125	Washer			
	1- A 3116-C	Bolt	2- B 3123-A	Bearing	2- B 3288	Retainer			
B 3111	4-11A 3110-A	Bushing	2- B 3121	Felt	2- B 3124-A	Nut	1	Pass & Comm	32-34
	1- B 3115	Bolt	2- B 3122	Pin	2- B 3125	Washer			
	1- B 3116	Bolt	2- B 3123-A	Bearing	2- B 3288	Retainer			
BB 3111	4- BB 3109	Bushing	2- B 3121	Felt	2- 33802-S8	Nut	1	Trucks	30-34
	1- BB 3115	Bolt	2- B 3122	Pin	2- 34808-S8	Lockwasher			
	1- BB 3116	Bolt	2- BB 3123-A	Bearing					
48 3111	4-11A 3110-A	Bushing	2- B 3121	Felt	2- B 3124-A	Nut	1	Pass & Comm	35-36
	1- 48 3115	Bolt	2- B 3122	Pin	2- B 3125	Washer			
	1- 48 3116	Bolt	2- B 3123-A	Bearing	2- B 3288	Retainer			
51 3111	4- BB 3109	Bushing	2- B 3121	Felt	2- 33802-S8	Nut	1	Trucks	35-37
	1- 51 3115	Bolt	2- B 3122	Pin	2- 34808-S8	L/washer			
	1- 51 3116	Bolt	2- BB 3123-A	Bearing					
78 3111	4-11A 3110-A	Bushing	2- B 3122	Pin	2- B 3124-A	Nut	1	Pass & Comm	37-41
	2-92Y 3115-A	Bolt	2- B 3123-A	Bearing	2- B 3125	Washer			
			2- B 3288	Retainer					
81T 3111	4-81T 3109-A	Bushing	2-81T 3123-A	Bearing	2- 33802-S8	Nut	1	Trucks except 122"	38-47
	2-81T 3115	Bolt	2-81T 3125	Washer	2- 34808-S8	L/washer			
	2-81T 3122	Pin	2-81T 3288	Retainer					
21A 3111-A	4-51A 3110-A	Bushing	2- B 3122	Pin	2- B 3124-A	Nut	1	Pass	42-48
	2-21A 3115-A	Bolt	2- B 3123-A	Bearing	2- B 3125	Washer			
			2- B 3288	Retainer					
21A 3111-B	4-51A 3110-A	Bushing	2- B 3123-A	Bearing	2- B 3125	Washer	1	Comm, 122" Truck	42-47
	2-21A 3115-A	Bolt	2- AA 3124	Nut	2- B 3288	Retainer			
	2- B 3122	Pin	2- B 3124-A	Nut					



CHASSIS PARTS CATALOGUE

PART NUMBER	CONSISTS OF			No. Req'd	MODEL	YEAR 19__
SPINDLE CONNECTING ROD END KIT						
11A 3270	1-11A 3289-A End 1- 72035-S7-8 Cotter Pin	1- 78 3332-A Seal 1- 351059-S Nut	1- 78 3336 Retainer 1- 353043-AS7 Fitting	1	(Pass 1935-48)(Comm, 122" Truck 1935-47)	35-48
8C 3270	1- 8C 3289 End	1- 8C 3332 Seal 1- 351059-S Nut	1- 72035-S7-8 Cotter Pin	1	(Pass 1935-48)(Comm, 122" Truck 1935-47)	35-48

DRAG LINK END AND SPINDLE CONNECTING ROD END KIT

11A 3271	1-11A 3290-A End 1- 72035-S7-8 Cotter Pin	1- 78 3332-A Seal 1- 351059-S Nut	1- 78 3336 Retainer 1- 353043-AS7 Fitting	2	(Pass 1935-48)(Comm, 122" Truck 1935-47)	35-48
7RT 3271	1-7RT 3290 End 1- 353027-AS8 Fitting	1-59T 3332 Seal 1-9/16"-18 Nut	1- 72035-S7-8 Cotter Pin	1	Trucks except 122"	35-47
8C 3271	1- 8C 3290 End	1- 8C 3332 Seal 1- 351059-S Nut	1- 72035-S7-8 Cotter Pin	1	(Pass 1935-48)(Comm, 122" Truck 1935-47)	35-48

FRONT SPRING SHACKLE KIT

A 5304	4- Studs	8- Bushings 8- 34370-S8 Locknut	4- Bars	1	Pass, Comm Trucks	28-31 28-29
B 5304-B	4- Studs	8- Bushings 8- 34370-S8 Locknut	4- Bars	1	Pass	32-34
48 5304-A	4-51A 5465 Stud	4-91A 5468-A Bar	8- 34370-S8 Locknut	1	Pass, Comm 122" 3/4 Ton Truck	35-40 38-39
48 5304-B	4- 48 5465-B Stud	8- 48 5467 Bushing 8- 34370-S7 Locknut	4- A 5468 Bar	1	Pass	35-41
11A 5304-A	4-51A 5464 Stud	4-11A 5468-A Bar	8- 34370-S8 Locknut	1	Pass	41
11A 5304-B	4- Studs	4- Bars 8- 34370-S8 Locknut	8- 48 5467 Bushing	1	Pass	41
21A 5304-A	2-51A 5464 Stud 2-21A 5465-A Stud	4-21A 5467-A Bushing 4-21A 5468-D Bar	4- 34370-S8 Locknut 4- 34422-S Locknut	1	Pass	42-48
21A 5304-B	4- Studs 4- Bars	4- 48 5467 Bushing 4-21A 5467-B Bushing	4- 34370-S8 Locknut 4- 34372-S7 Locknut	1	Pass	42-48
A 5630	4- Studs	4- Bars 8- 34370-S8 Locknut	8- A 5719 Bushing	1	Trucks	30-34

REAR SPRING SHACKLE KIT

A 5630	4- Studs	4- Bars 8- 34370-S8 Locknut	8- A 5719 Bushing	1	Pass, Comm Pass, Comm Trucks	28-31 28-40 28-33
B 5630-B	4- Studs 4- Bars	4- A 5719 Bushing 8- 34370-S8 Locknut	4- Bushings	1	Pass	32-34
48 5630	4-51A 5713 Stud	4-91A 5468 Bar	8- 34370-S8 Locknut	1	Pass, Comm	35-40
11A 5630-A	4-11A 5468-A Bar	4-51A 5713 Stud	8- 34370-S8 Locknut	1	Pass	41



CHASSIS PARTS CATALOGUE

PART NUMBER	CONSISTS OF				No. REQ'D	MODEL	YEAR 19__
REAR SPRING SHACKLE KIT - Continued							
11A 5630-B	4- Studs	4- Bars	8- A 5719 Bushing	8- 34370-S8 Locknut	1	Pass	41
21A 5630-A	2-51A 5713 Stud	4-21A 5719-A Bushing	4- 34370-S8 Locknut	2-21A 5714-A Stud	4-21A 5468-D Bar	4- 34422-S Locknut	42-48
21A 5630-B	4- Studs	4-21A 5719-B Bushing	4- 34370-S8 Locknut	4- A 5719 Bushing	4-21A 5468-E Bar	4- 34372-S7 Locknut	42-48
ENGINE OVERHAUL GASKET SET							
18 6008-A	1- 18 6020 Gasket (cyl.frt.cover)	2- 18 8280 Gasket (inlet conn.)	2- 40 6051-B Gasket (cyl.head)	2- 40 8280 Gasket (inlet conn.)	1	Pass,Comm,Trucks 90 HP (8 cyl.)	32-37
	1- 40 6521 Gasket (vlv.chmbr.cover)	2- 18 8507 Gasket (water pump hsg.)	1- 18 6626 Gasket (oil screen cover)	2- 78 8507 Gasket (water pump hsg.)			
	1- 68 6626 Gasket (oil screen cover)	2- 78 8529 Gasket (pump hole cvr.)	2-41A 6626 Gasket (oil pump)	1- 48 9374 Gasket (adapter)			
	1- 18 6659-A Gasket (oil pump dr.cvr.)	1- 40 9417 Gasket (fuel pump)	1- 18 6659-B Gasket (oil pump dr.cvr.)	1- 18 9447 Gasket (carb. flange)			
	1- B 6700-A Packing (cyl.frt.cover)	1- 40 9447-A Gasket (carb. flange)	1- B 6734 Gasket (drain plug)	6- 18 9448-A Gasket (exhaust man.)			
	1- 52 6734 Gasket (drain plug)	3- 18 9449-A Gasket (muffler inlet)	1- 48 6781 Gasket set (oil pan)	1- 68 12143 Gasket (dist. base)			
	1-1GA 12143 Gasket (dist. base)						
18 6008-B	1- 18 6020 Gasket (cyl.frt.cover)	2- 18 8280 Gasket (inlet conn.)	2-41A 6051 Gasket (cyl. head)	2- 40 8280 Gasket (inlet conn.)	1	Pass,Comm,Trucks-90 HP	32-42
	1- 40 6521 Gasket (vlv.chmbr.cover)	2- 18 8507 Gasket (water pump hsg.)	1- 18 6626 Gasket (oil screen cover)	2- 78 8507 Gasket (water pump hsg.)			
	1- 68 6626 Gasket (oil screen cover)	2- 78 8529 Gasket (pump hole cvr.)	2-41A 6626 Gasket (oil pump)	1- 48 9374 Gasket (adapter)			
	1- 18 6659-A Gasket (oil pump dr.cvr.)	1- 40 9417 Gasket (fuel pump)	1- 18 6659-B Gasket (oil pump dr.cvr.)	1- 18 9447 Gasket (carb. flange)			
	1- B 6700-A Packing (cyl.front cover)	1- 40 9447-A Gasket (carb. flange)	1- B 6734 Gasket (drain plug)	9- 18 9448-A Gasket (man.&muffler)			
	1- 52 6734-A Gasket (drain plug)	1- 68 12143 Gasket (dist. base)	1- 48 6781 Gasket set (oil pan)	1-1GA 12143 Gasket (dist. base)			
74 6008	1- 52 6020 Gasket (cyl.frt.cover)	1- 52 6734-A Gasket (drain plug)	2- 52 6051-B Gasket set (oil pan)	1- 52 6781 Gasket set (oil pan)	1	Pass,Comm,Trucks 60 HP (8 cyl.)	37-39
	1- 52 6521-B Gasket (vlv.chmbr.cover)	1- 40 9417 Gasket (adapter)	1- 52 6619 Gasket (oil pump cover)	1- 40 9447-A Gasket (carb. flange)			
	1- 52 6700-A Packing (cyl.front cover)	6- 52 9448-A Gasket (exhaust man.)	1- B 6734 Gasket (drain plug)	2- 52 9450-A Gasket (muffler inlet)			
	1- 68 12143 Gasket (dist. base)						
81A 6008-A	1- 18 6020 Gasket (cyl.frt.cover)	1- 52 6734-A Gasket (drain plug)	2-91A 6051-A Gasket (cyl.head)	1- 48 6781 Gasket set (oil pan)	1	Pass,Comm,Trucks 90 HP (8 cyl.)	38-42
	1- 40 6521 Gasket (vlv.chmbr.cover)	2- 78 8507 Gasket (water pump)	2-41A 6626 Gasket (oil pump)	1- 48 9374 Gasket (adapter)			
	1- 18 6659-A Gasket (oil pump dr.cvr.)	1- 40 9417 Gasket (adapter)	1- 18 6659-B Gasket (oil pump dr.cvr.)	1- 40 9447-A Gasket (carb. flange)			
	1- B 6700-A Packing (cyl.front cover)	9- 18 9448-A Gasket (man.&muffler)	1- B 6734 Gasket (drain plug)	1- 68 12143 Gasket (dist. base)			
	1- 68 12143 Gasket (dist. base)						



CHASSIS PARTS CATALOGUE

PART NUMBER	CONSISTS OF				No. Req'd	MODEL	YEAR 19__
ENGINE OVERHAUL GASKET SET - Continued							
7HA 6008	1-7HA 6018 Gasket (cyl.side cover)	1-7HA 6701 Packing(rear brg.ret.)	1	Pass (6 cyl. "H" Series)	47-48		
	1-7HA 6020 Gasket (cyl.front cover)	1-7HA 6781 Gasket set(oil pan)	1	Trucks (6 cyl "H" Series)	47		
	1-7HA 6051 Gasket (cyl.head)	1-7HA 6838 Gasket(oil filter mtg.)					
	1-7HA 6344 Gasket (rear brg.ret.)	1-7HA 8255 Gasket(water conn.)					
	3-7HA 6521 Gasket (vlv.chmbr.cover)	1-7HA 8507 Gasket(water pump mtg.)					
	1-7HA 6619 Gasket (oil pump cover)	1-1GA 9417 Gasket(fuel pump mtg.)					
	1-7HA 6626 Gasket (oil pump tube)	1-1GA 9433 Gasket set (manifold)					
	1-7HA 6659-B Gasket (oil pump mtg.)	1-1GA 9435-C Gasket (manifold)					
	1-1GA 6669 Gasket(oil rel.vlv.nut)	1-7HA 9447 Gasket(carburetor mtg.)					
	1-1GA 6700-A Packing (cyl.front cover)	1-1GA 9450 Gasket (man. outlet)					
VALVE OVERHAUL GASKET SET							
40 6079	2- 40 6051-B Gasket (cyl. head)	1- 40 6521 Gasket(vlv.chmbr. cvr.)	1	Pass,Comm,Trucks-90 HP (8 cyl.)	32-36		
	2- 18 8507 Gasket (water pump hsg.)						
ENGINE OIL PAN GASKET SET							
A 6781	1- B 6700-A Packing-front	1- A 6710 Gasket-RH	1	Pass,Comm,Trucks (4 cyl.)	28-29		
	1- A 6701-B Packing-rear	1- A 6711 Gasket-LH					
B 6781	1- B 6700-A Packing-front	1- B 6710 Gasket-RH	1	Pass,Comm,Trucks (4 cyl.)	32-34		
	1- B 6701-B Packing-rear	1- B 6711 Gasket-LH					
48 6781	1- B 6700-A Packing-front	1- 48 6710 Gasket-RH	1	Pass-90 & 100 HP (8 cyl.)	32-48		
	1- 18 6701-B Packing-rear	1- 18 6711 Gasket-LH	1	Comm,Trucks-90 & 100 HP (8 cyl.)	32-47		
	1- 48 6711 Gasket-LH						
52 6781	1- 52 6700-A Packing-front	1- 52 6710-C Gasket-RH	1	Pass,Comm,Trucks-60 HP (8 cyl.)	37-39		
	1- 52 6701 Packing-rear	1- 52 6711-C Gasket-LH					
022A 6781	1-022A 6347 Packing-rear	1-022A 6710 Gasket-RH	1	Pass,Comm,Trucks-60 HP (8 cyl.)	40		
	1- 52 6700-A Packing-front	1-022A 6711 Gasket-LH					
1GA 6781	1-1GA 6701-A Packing-rear	1-1GA 6710-B Gasket-RH	1	Pass,Comm,Trucks (6 cyl. "G" Series)	41-47		
	1-1GA 6707-A Packing-front	1-1GA 6711-B Gasket-LH					
	1-91A 6734 Gasket (drain plug)						
7HA 6781	1-7HA 6702 Packing-rear	2-7HA 6710-B Gasket-side	1	Pass (6 cyl "H" Series)	47-48		
	1-1GA 6707-A Packing-front	1-86H 6734 Gasket (drain plug)	1	Trucks (6 cyl. "H" Series)	47		
18 18512	2- B 6700-A Packing-front	1- 48 6710 Gasket-RH	1	Pass,Comm,Trucks (8 cyl.)	32-34		
	1- 18 6701-B Packing-rear	1- 18 6711 Gasket-LH					
UNIVERSAL JOINT GASKET SET							
B 7038	2- B 4515 Gasket	1- B 4516-A Seal	1	Pass,Comm,Trucks (4 speed transmission)	32-48		
BB 7038	2- BB 4509 Gasket	1- BB 4515 Gasket	1	Comm,Trucks (3 speed transmission)	28-47		



CHASSIS PARTS CATALOGUE

PART NUMBER	CONSISTS OF					No. Req'd	MODEL	YEAR
UNIVERSAL JOINT REPAIR KIT								
01Y 7039	4-01Y 7074	Bearing	1-01Y 7084	Spider	4-01Y 7096	Ring	2 (Comm 1942-47)(122" Trucks 1940-47)	40-47
01T 7039	4-01T 7074-B	Bearing	1-01T 7084-B	Spider	4-01T 7096-A	Ring	2 Trucks	40-47
21C 7039	4-21C 7074	Bearing	1-21C 7084	Spider	4-01Y 7096	Ring	2 Comm	42-47

TRANSMISSION AND UNIVERSAL JOINT GASKET SET

B 7153	1- 74 7051	Gasket (brg.retainer)	1- B 7223	Gasket(gear shift hsg)	1	Pass,Comm,Trucks (3 speed transmission)	32-47
	1- 78 7051	Gasket (brg.retainer)	1- 74 7223	Gasket(gear shift hsg)			
	1- B 7086	Gasket (brg.retainer)	1-01A 7223	Gasket(gear shift hsg)			
	1- 74 7086	Gasket (brg.retainer)	2- B 4515	Gasket (u/joint)			
	1- 40 7207	Gasket (gear shift cap)	1- B 4516-A	Seal (u/joint)			
BB 7153	2- BB 4509	Gasket (u/j hsg.cap)	1- 8D 7086	Gasket (brg.retainer)	1	Comm,Trucks (4 speed transmission)	32-47
	1- BB 4515	Gasket (u/joint)	1- BB 7166 -A	Gasket (P.T.O. cover)			
	1- BB 7051	Gasket (brg.retainer)	1- BB 7223	Gasket(gear shift hsg)			
	1- BB 7086	Gasket (brg.retainer)	1- BB 7620	Gasket(clutch housing)			

WATER PUMP REPAIR KIT

A 8591	1- A 8507	Gasket	1- A 8513	Washer	1- B 8521	Packing	1	Pass,Comm,Trucks(4 cyl)	28-31
	1- A 8510	Shaft	1- B 8520	Bushing	1- B 8523-A	Nut			
B 8591	1- B 8507	Gasket	2- B 8513	Washer	1- B 8521	Packing	1	Pass,Comm,Trucks(4 cyl)	32-34
	1- B 8510	Shaft	1- B 8520	Bushing	1- B 8523-A	Nut			
68 8591	1- 18 8507	Gasket	1- 18 8540	Retainer	1- 18 8554	Washer	2	(Pass,Comm 1932-36) (Trucks 1932-34)(8 cyl)	32-36
	1- 68 8510-B	Shaft	1- 18 8542	Felt	1- 68 8557-A	Washer			
	2- 18 8520	Bushing	1- 68 8551	Seal	1- 68 8574	Ring			
			1- 352503-S8	Pin					
78 8591	1- 78 8507	Gasket	1- 78 8520	Bushing	1- 68 8557-A	Washer	2	(Pass 1937-48)(Comm 1937-47)(122" Truck 1938-39)(Trucks except COE 1940-41)(Trucks 1942-47)(8 cyl)	37-48
	1- 78 8511-B	Shaft	1- 68 8551	Seal	1- 68 8574	Ring			
	1- 78 8512	Impeller	1- 18 8554	Washer	1- 352503-S8	Pin			
2GA 8591	1-5GA 8512	Impeller	1-2GA 8543	Gasket	1- 68 8573	Guide	1	Pass,Comm,Trucks(6 cyl "G" Series)	42-47
	1-2GA 8524	Seal	1- 68 8557-A	Washer	1- 68 8574	Snap ring			
	1-2GA 8530-A	Bearing	1-2GA 8560	Spring	1- 9N 8576	Snap ring			
	1-2GA 8531	Snap ring	1-2GA 8572	Ring					
7HA 8591	1-7HA 8507	Gasket	1-2GA 8530-A	Bearing	1-7RA 8564-B	Seal	1	Pass (6 cyl "H" Series) Comm,Trucks (6 cyl "H" Series)	47-48
	1-7HA 8512	Impeller	1-7HA 8550	Slinger	1-7HA 8576	Snap ring			



CHASSIS PARTS CATALOGUE

PART NUMBER	CONSISTS OF						No. REQ'D	MODEL	YEAR 19__
FUEL PUMP REPAIR KIT									
68 9349	1- 40 9357 Washer	1- 68 9364 Gasket	1- 40 9380 Spring				1	Pass,Comm,Trucks 60,90 & 100 HP (8 cyl)	32-40
	2- 40 9358-A Valve	1- 40 9365 Screen	1- 40 9381-A Link						
	2- B 9360 Spring	1- 68 9365-A Screen	1- 40 9389 Bushing						
	1- 40 9363 Gasket	1- 40 9376-B Arm	1- 40 9396 Spring						
	1- 40 9364 Gasket	1- 40 9378 Pin	1- 68 9398 Diaphragm						
11A 9349	2-11A 9352 Valve	1-59A 9368 Screen	1- 40 9396 Spring				1	Pass 90 & 100 HP(8 cyl)	32-48
	1- 40 9357 Washer	1- 40 9376-B Arm	1- 68 9398 Diaphragm				1	Comm,Trucks 90 & 100 HP (8 cyl)	32-47
	1- 68 9364 Gasket	1- 40 9378 Pin	1- 40 9417 Gasket						
	1-59A 9364 Gasket	1- 40 9380 Spring	3- 31628-S7 Screw						
	1-11A 9365 Screen	1- 40 9381-A Link	3- 34803-S7 L/washer						
	1-11A 9367 Gasket	1- 40 9389 Bushing							
1GA 9349-A	2-11A 9352 Valve	1-11A 9367 Gasket	1-1GA 9381 Link				1	Pass,Comm,Trucks 90 HP (6 cyl"G" Series)	41-47
	1- 40 9357 Washer	1-1GA 9376 Arm	1- 40 9396 Spring						
	1- 68 9364 Gasket	1-1GA 9378 Pin	1- 68 9398 Diaphragm						
	1-11A 9365 Screen	1- 40 9380 Spring	1-1GA 9417 Gasket						
		2-1GA 9469 Oil Seal							
7HA 9349	2-11A 9352 Valve	1-7HA 9376 Arm	1-7HA 9396 Spring				1	Pass (6 cyl"H" Series)	47-48
	1-59A 9364 Gasket	1-1GA 9378 Pin	1-7HA 9398 Diaphragm				1	Trucks (6 cyl."H" Series)	47
	1-11A 9367 Gasket	1- 40 9380 Spring	1-1GA 9411 Washer						
	1-59A 9368 Screen	1-1GA 9381 Link	1-1GA 9417 Gasket						
	1-1GA 9468 Retainer	2-1GA 9469 Oil Seal							
MANIFOLD GASKET SET									
B 9433	2- B 9448-A Gasket						1	Pass,Comm,Trucks (4 cyl.)	28-34
18 9433	9- 18 9448-A Gasket						1	Pass,Comm,Trucks-90 & 100 HP (8 cyl.)	32-48
52 9433	2- 52 9450-A Gasket	6- 52 9448-A Gasket					1	Pass,Comm,Trucks-60 HP (8 cyl.)	37-40
1GA 9433	1-1GA 9441 Gasket-rear	1-1GA 9442 Gasket-front					1	Pass (6 cyl.)	41-48
	1-1GA 9448 Gasket-center						1	Trucks (6 cyl.)	41-47
CARBURETOR GASKET SET									
52 9502	1- 52 9516 Gasket	3- 40 9563 Gasket	2- 40 9608 Gasket				1	Pass,Comm,Trucks-60 HP (8 cyl.)	37-39
	1- 48 9519 Gasket	1- 40 9569 Gasket	1- 40 9634 Gasket						
67 9502	1- 40 9516 Gasket	3- 40 9563 Gasket	2- 40 9608 Gasket				1	Pass,Comm,Trucks-90 HP (8 cyl.)	34-38
	1- 48 9519 Gasket	1- 40 9569 Gasket	1- 40 9634 Gasket						



CHASSIS PARTS CATALOGUE

PART NUMBER	CONSISTS OF						No. REQ'D	MODEL	YEAR 19__
CARBURETOR GASKET SET - Continued									
9N 9502	1- 9N 9447	Gasket (carb.to man.)	1- 9N 9563	Gasket (adj.needle)			1	Comm,Trucks 40 HP (4 cyl.)	41-42
	1- 9N 9519	Gasket (throttle body)	1- 9N 9569	Gasket (flt.vlv.seat)					
		1- 9N 9608	Gasket (main nozzle)						
1GA 9502	1-1GA 9516	Gasket	1- 78 9569	Gasket	1- 78 9625-A	Gasket	1	Pass,Comm,Trucks (6 cyl. "G" Series)	41-47
	1-1GA 9519	Gasket	1- 40 9608	Gasket	2- 78 9926	Gasket			
21A 9502	1- 7RA 9516	Gasket	2- 78 9563	Gasket	1- 78 9909	Gasket	1	Pass,Comm,Trucks-90 & 100 HP (8 cyl.)	38-48
	1-922A 9516	Gasket	1- 78 9569	Gasket	2- 78 9925-A	Gasket	1	Pass,Comm,Trucks-60 HP (8 cyl.)	39-40
	1- 78 9519	Gasket	1- 78 9580	Gasket	4- 78 9926	Gasket			
7HA 9502	1-7HA 9516	Gasket (throttle body)	1- 78 9569	Gasket (float needle)			1	Pass (6 cyl "H" Series)	47-48
	1-1GA 9519-B	Gasket (main body)	1- 40 9608	Gasket (power jet)			1	Comm,Trucks (6 cyl "H" Series)	47
		1- 78 9926	Gasket (nozzle bar)						

CARBURETOR REPAIR KIT

67 9590	1- 40 9447-A	Gasket	3- 40 9563	Gasket	1- 40 9608	Gasket	1	Pass,Comm,Trucks-90 HP (8 cyl.)	36-37
	1- 40 9516	Gasket	1- 40 9564	Needle	1- 40 9631	Piston			
	1- 48 9519	Gasket	1- 40 9571	Spring	1- 67 9632	Retainer			
	2- 67 9533-A	Jet-.045"	1- 40 9573	Valve	1- 40 9634	Gasket			
	2- 40 9541	Needle	4- 40 9586	Screw	1- 40 9636	Spring			
	2- 40 9542	Jet	1- 67 9594	Jet	1- 67 9637	Seat			
		1- 40 9639	Washer	1- 40 9640	Spring				
81A 9590-A	1- 40 9447-A	Gasket	2- 78 9542	Jet	1- 78 9631	Piston	1	Pass,Comm,Trucks-90 & 100 HP (8 cyl.)	38-46
	1-7RA 9516	Gasket	1- 78 9548	Lever	1- 78 9636	Spring			
	1- 78 9519	Gasket	2- 78 9563	Gasket	1- 78 9904	Valve			
	2- 78 9533-B	Jet	1-7HA 9564	Needle	1- 78 9909	Gasket			
	2- 78 9541	Needle	1- 78 9580	Gasket	2- 78 9925-A	Gasket			
			4- 78 9926	Gasket					
81A 9590-B	1- 40 9447-A	Gasket	2- 78 9542	Jet	1- 78 9631	Piston	1	Pass,Comm,Trucks-90 & 100 HP (8 cyl.)	38-46
	1-7RA 9516	Gasket	1- 78 9548	Lever	1- 78 9636	Spring			
	1- 78 9519	Gasket	2- 78 9563	Gasket	1- 78 9904	Valve			
	2- 78 9533-B	Jet	1-7HA 9564	Needle	1- 78 9909	Gasket			
	2- 78 9541	Needle	1- 78 9580	Gasket	2- 78 9925-A	Gasket			
			4- 78 9926	Gasket					
59A 9590-A	1- 40 9447-A	Gasket	2- 78 9542	Jet	1- 78 9631	Piston	1	Pass,Comm,Trucks-90 & 100 HP (8 cyl.)	46-48
	1-7RA 9516	Gasket	1- 78 9548	Lever	1- 78 9636	Spring			
	1- 78 9519	Gasket	2- 78 9563	Gasket	1- 78 9904	Valve			
	2-59A 9533-A	Jet	1-7HA 9564	Needle	1- 78 9909	Gasket			
	2- 78 9541	Needle	1- 78 9580	Gasket	2- 78 9925-A	Gasket			
			4- 78 9926	Gasket					
59A 9590-B	1- 40 9447-B	Gasket	2- 78 9542	Jet	1- 78 9631	Piston	1	Pass,Comm,Trucks-90 & 100 HP (8 cyl.)	46-48
	1- 78 9516	Gasket	1- 78 9548	Lever	1- 78 9636	Spring			
	1- 78 9519	Gasket	2- 78 9563	Gasket	1- 78 9904	Valve			
	2-59A 9533-B	Jet	1-7HA 9564	Needle	1- 78 9909	Gasket			
	2- 78 9541	Needle	1- 78 9580	Gasket	2- 78 9925-A	Gasket			
			4- 78 9926	Gasket					



CHASSIS PARTS CATALOGUE

PART NUMBER	CONSISTS OF						No. REQ'D	MODEL	YEAR 19__
-------------	-------------	--	--	--	--	--	--------------	-------	--------------

CARBURETOR REPAIR KIT—Continued

5GA 9590	1-1GA 9447 Gasket 1-1GA 9516 Gasket 1-1GA 9519-B Gasket 1-1GA 9526 Link 1-5GA 9533-A Jet	1- 78 9541 Needle 1-1GA 9542-B Jet 1-1GA 9548 Lever 1-7HA 9564 Needle 1-1GA 9599 Retainer 2- 78 9926 Gasket	1- 40 9608 Gasket 1- 78 9631 Piston 1- 78 9636 Spring 1-1GA 9904-B Valve 1- 78 9925-A Gasket	1	Pass,Comm,Trucks (6 cyl. "G" Series)	41-47
7HA 9590-A	1-7HA 9447 Gasket 1-7HA 9516 Gasket 1-1GA 9519-B Gasket 1-1GA 9526 Link 1-1GA 9533-A Jet-.065	1- 78 9541 Needle 1-1GA 9542-B Jet 1-7HA 9564 Needle 1-1GA 9599 Retainer 1- 40 9608 Gasket 1-7HA 9942 Screen	1- 78 9631 Piston 1- 78 9636 Spring 1-1GA 9904-B Valve 1- 78 9925-A Gasket 2- 78 9926 Gasket	1	Pass,Trucks (6 cyl. "H" Series)	47-48
7HA 9590-B	1-7HA 9447 Gasket 1-7HA 9516 Gasket 1-1GA 9519-B Gasket 1-1GA 9526 Link 1-1GA 9533-B Jet-.063	1- 78 9541 Needle 1-1GA 9542-B Jet 1-7HA 9564 Needle 1-1GA 9599 Retainer 1- 40 9608 Gasket 1-7HA 9942 Screen	1- 78 9631 Piston 1- 78 9636 Spring 1-1GA 9904-B Valve 1- 78 9925-A Gasket 2- 78 9926 Gasket	1	Pass (6 cyl. "H" Series)	47-48

GENERATOR BRUSH SET

40 10043	2- 40 10069 Brush	1- 40 10070 Brush	1	Pass,Comm,Trucks	29-39
91A 10043	2-91A 10069 Brush		1	Pass,Comm,Trucks	32-39
01A 10043	2-01A 10069 Brush		1	Pass,Comm,Trucks	40-48
99B 10043	2-99B 10069 Brush	2-99B 10070 Brush	1	Pass,Comm,Trucks (8 cyl.)	42-48
19B 10043-A	4-19B 10070-B Brush		1	Pass,Comm,Trucks (6 cyl.)	42-48

STARTER BRUSH SET

18 11057	2- 18 11055 Brush	2- 18 11056 Brush	1	Pass,Comm,Trucks (8 cyl.)	32-48
			1	Pass,Comm,Trucks (6 cyl.)	41-48

DISTRIBUTOR GASKET SET

18 12104	2- 18 12108 Gasket (term.plate) 2- 18 12115 Ring (term.plate cap)	1- 18 12140-A Gasket (ign.coil) 1- 78 12140-A Gasket (ign.coil) 1- 68 12143 Gasket (dist.to frt.cover)	1	Pass,Comm,Trucks (8 cyl.)	32-41
21A 12104	1-59A 12108 Gasket (term.hsg.cap) 1-21A 12114 Gasket (term.housing) 1-1GA 12114-B Gasket (term.housing)	1-1GA 12134 Seal (hsg.vacuum) 1-1GA 12143 Gasket (dist.to cover) 1-1GA 12312 Cap (dist.condenser)	1	Pass,Comm,Trucks (8 cyl.)	42-48
21A 12104	1-59A 12108 Gasket (term.hsg.cap) 1-21A 12114 Gasket (term.housing) 1-1GA 12114-B Gasket (term.housing)	1-1GA 12134 Seal (hsg.vacuum) 1-1GA 12143 Gasket (dist.to cover) 1-1GA 12312 Cap (dist.condenser)	1	Pass,Comm,Trucks (6 cyl. "G" Series)	41-47



CHASSIS PARTS CATALOGUE

PART NUMBER	CONSISTS OF	No. REQ'D	MODEL	YEAR 19__
DISTRIBUTOR POINT SET (BREAKER ARM & CONTACT)				
18 12107	1- 18 12162-B Arm 2- 18 12172-B Points 2- 352200-S Cotter pin 2-351301-S Washer	1	Pass,Comm,Trucks (8 cyl.)	32-36
78 12107	2- 68 12162 Arm 1- 68 12218 Pt.& brkt. 1- 68 12219 Pt.& brkt. 2- 351260-S Washer 2- 351201-S C/pin 2- 355016-S7 Screw	1	Pass,Comm,Trucks (8 cyl.)	36-48
1GA 12107	1- 68 12162 Arm 1- 352201-S Cotter pin 1- 68 12219 Pt.& brkt. 1- 351260-S Washer 1- 355016-S7 Screw	1	Pass,Comm,Trucks (6 cyl.)	41-47
A 12199	1- A 12162 Breaker arm 1- B 12172 Contact point	1	Pass,Comm,Trucks (4 cyl.)	28-31
B 12199	1- B 12162 Breaker arm 1- B 12172 Contact point	1	Pass,Comm,Trucks (4 cyl.)	32-34

SPARK PLUG WIRE SET

18 12259-A	2- 18 12113 Seal 2- 18 12286 Wire 2- 18 12283 Wire 2- 18 12284 Wire 2- 18 12287 Wire	1	Pass,Comm,Trucks (8 cyl.)-90 HP	32-36
18 12259-B	1-Wire assy 21.75" to 22.25" long 1-Wire assy 25.75" to 26.25" long 3-Wire assy 36.50" to 37.00" long 2-Wire assy 27.75" to 28.25" long 1-Wire assy 32.25" to 32.75" long	1 1	Pass-90 & 100 HP (8 cyl.) Comm,Trucks-90 & 100 HP (8 cyl.)	32-48 32-47
74 12259	2- 18 12113 Seal 2- 74 12286 Wire 2- 74 12283 Wire 2- 74 12284 Wire 2- 74 12287 Wire	1	Pass,Comm,Trucks (8 cyl.)-60 HP	37-40
78 12259	Replaced by 18-12259-B 2- 18 12113 Seal 2- 78 12286 Wire 2- 78 12283 Wire 2- 78 12284 Wire 2- 78 12287 Wire	1	Pass,Comm,Trucks (8 cyl.)-90 & 100 HP	37-41
1GA 12259-A	6- 9N 12113-A Seal 1-1GA 12282 Wire 1-1GA 12287 Wire 1-1GA 12283 Wire 1-1GA 12284 Wire 1-1GA 12298 Wire 1-1GA 12285 Wire 1-1GA 12286 Wire	1	Pass,Comm,Trucks (6 cyl.)-90 HP	41-42
1GA 12259-B	1-Wire assy 20.50" to 21.00" long 1-Wire assy 22.50" to 23.00" long 1-Wire assy 28.50" to 29.00" long 1-Wire assy 31.00" to 31.50" long 1-Wire assy 37.50" to 38.00" long 1-Wire assy 40.00" to 40.50" long	1	Pass,Comm,Trucks (6 cyl.)-"G" Series	41-47
21A 12259	8- 9N 12113-A Seal 1-21A 12282 Wire 1-21A 12283 Wire 1-21A 12284 Wire 1-21A 12285 Wire 1-21A 12286 Wire 1-21A 12298 Wire 1-21A 12287 Wire 1-21A 12295 Wire 1-21A 12296 Wire	1	Pass,Comm,Trucks (8 cyl.)-90 & 100 HP	42-44
59A 12259	2-59A 12110 Conduit 1- 9N 12113-A Seal 1-59A 12113 Insulator 1-59A 12282 Wire 1-59A 12283 Wire 1-59A 12284 Wire 1-59A 12285 Wire 1-59A 12286 Wire 1-59A 12298 Wire 1-59A 12287 Wire 1-59A 12295 Wire 1-59A 12296 Wire 1-59A 12297 Insulator	1	Pass,Comm,Trucks (8 cyl.)-90 & 100 HP	45-48



CHASSIS PARTS CATALOGUE

PART NUMBER	CONSISTS OF	No. Req'd	MODEL	YEAR 19__
SPARK PLUG WIRE SET—Continued				
5GA 12259	1-5GA 12113 Insulator 1- 9N 12113-A Seal 1-5GA 12283 Wire 1-5GA 12284 Wire 1-5GA 12287 Wire	1-5GA 12285 Wire 1-5GA 12286 Wire 1-5GA 12298 Wire	1 Pass, Comm, Trucks (6 cyl.) "G" Series	46-47
7HA 12259	6- 2N 12113 Seal (spark plug) 2- 2N 12113 Seal (coil) 1-7HA 12282-B Wire assy-No.5 1-7HA 12283-B Wire assy-No.2 1-7HA 12298-B Wire assy (hi-tension)	1-7HA 12284-B Wire assy-No.3 1-7HA 12285-B Wire assy-No.6 1-7HA 12286-B Wire assy-No.1 1-7HA 12287-B Wire assy-No.4	1 Pass (6 cyl.)-"H" Series 1 Comm, Trucks (6 cyl.) "H" Series	47-48 47
APA 12259-A	10- 18 12283 Wire assy-Nos.2 & 6 10- 18 12284 Wire assy-Nos.3 & 7	10- 18 12286 Wire assy-Nos.1 & 5 10- 18 12287 Wire assy-Nos.4 & 8	1 Pass, Comm, Trucks (8)	32-36

HORN AND BRACKET KIT

51A 13823	Sea Shell type-6 volt-double horn-includes horn assy, bracket, relay and attaching parts.	1	Pass	32-48
51T 13823-A	Sea Shell type-12 volt-double horn-includes horn assy, bracket, relay and attaching parts.	1	Comm, Trucks	32-47
51T 13823-B	Projector type-12 volt-single horn-includes horn assy, bracket and attaching parts.	1	Comm, Trucks	32-47
51T 13823-D	Projector type-6 volt-single horn-includes horn assy, bracket and attaching parts.	1	Comm, Trucks	32-47
51T 13823-E	Projector type-12 volt-single horn-includes horn assy, bracket and attaching parts.	1	Comm, Trucks	32-47

ELECTRICAL WIRING KIT

8A 14293	40- 2N 12113 Insulator 1- 8A 14294 Kit (wiring terminal) 1- 8A 14296-A Wire (high ten.)-16 gage 50- B 14466	1- 8A 14296-B Wire (primary)-16 gage 1- 8A 14296-C Wire (primary)-14 gage 1- 8A 14296-D Wire (primary)-12 gage Terminal (high tension wire)	As Req'd	Pass Comm, Trucks	28-48 28-47
----------	--	--	----------	----------------------	----------------

ELECTRICAL WIRING TERMINAL KIT

8A 24294	25- 78 14453 Terminal 25-7HA 14453 Terminal 50- 8A 14455-A Sleeve-#14-16 gage 50- 8A 14455-B Sleeve-#10-12 gage 1	50- 8A 14463-A Terminal-#14-16 gage 50- 8A 14463-B Terminal-#10-12 gage 50- 8A 14463-C Terminal-#14-16 gage 50- 8A 14488 Connector-#14-16 gage Wiring tool	As Req'd	Pass Comm, Trucks	28-48 28-47
----------	---	--	----------	----------------------	----------------



CHASSIS PARTS CATALOGUE

PART NUMBER	CONSISTS OF	No. REQ'D	MODEL	YEAR 19__
FUSE KIT				
B 14527	Five 20 Amp fuses	As Req'd	Pass, Comm, Trucks	28-39
APA 14527-A	21 Boxes-B 14527-20 Amp fuses 9 Boxes-APA 14527-B-3 Amp fuses 9 Boxes-APA 14527-C-9 Amp fuses 1-Plastic box-APR 14527	As Req'd	Pass Comm, Trucks	28-48 28-47
APA 14527-B	Five 3 Amp fuses	As Req'd	Pass	46-48
APA 14527-C	Five 9 Amp fuses	As Req'd	Pass, Comm, Trucks	38-40
APA 14527-D	Five 14 Amp fuses	As Req'd	Pass, Comm, Trucks Pass Comm, Trucks	38-40 46-48 46-47

WINDSHIELD WIPER BLADE KIT

APA 17528-B	2-21A 17528-E Blade 2-51A 17531-B Converter 2-51A 17531-C Converter	1 1	Pass Comm, Trucks (except COE)	40-48 40-47
-------------	---	--------	-----------------------------------	----------------

WINDSHIELD WIPER ARM AND DRIVER KIT

21A 17464	1-51A 17481 Nut 1-11A 17511 Driver 1-51A 17511-A Driver 1-51A 17511-C Driver 1- 357201-S Cotter pin	1	(Pass 1934-48)(Comm, Closed Cabs, Panels except COE-1934-47)	34-48
21A 17465-A	6-21A 17464 Arm & driver 12- 68 17528-C Blade	1	Pass, Comm, Trucks	28-36
21A 17465-B	6-21A 17464 Arm & driver 12- 78 17528-B Blade	1	Pass, Comm, Trucks	36-42

FRONT AND REAR SHOCK ABSORBER KIT

59A 18124	1-59A 18045-A Front shock absorber 4-51A 18197 Bushing	2	Pass	46-48
51A 18125-A	1-51A 18080-F Rear shock absorber 4-51A 18197 Bushing	2	Station Wagon Wagon	46-48
51A 18125-B	1-51A 18080-G Rear shock absorber 4-51A 18197 Bushing	2	Pass except Station Wagon	46-48

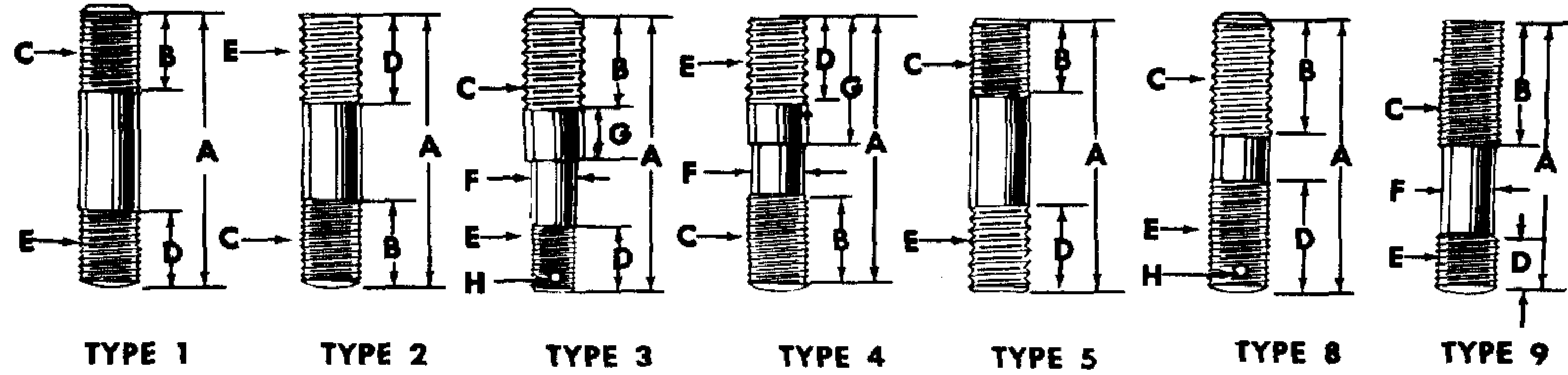

P-157

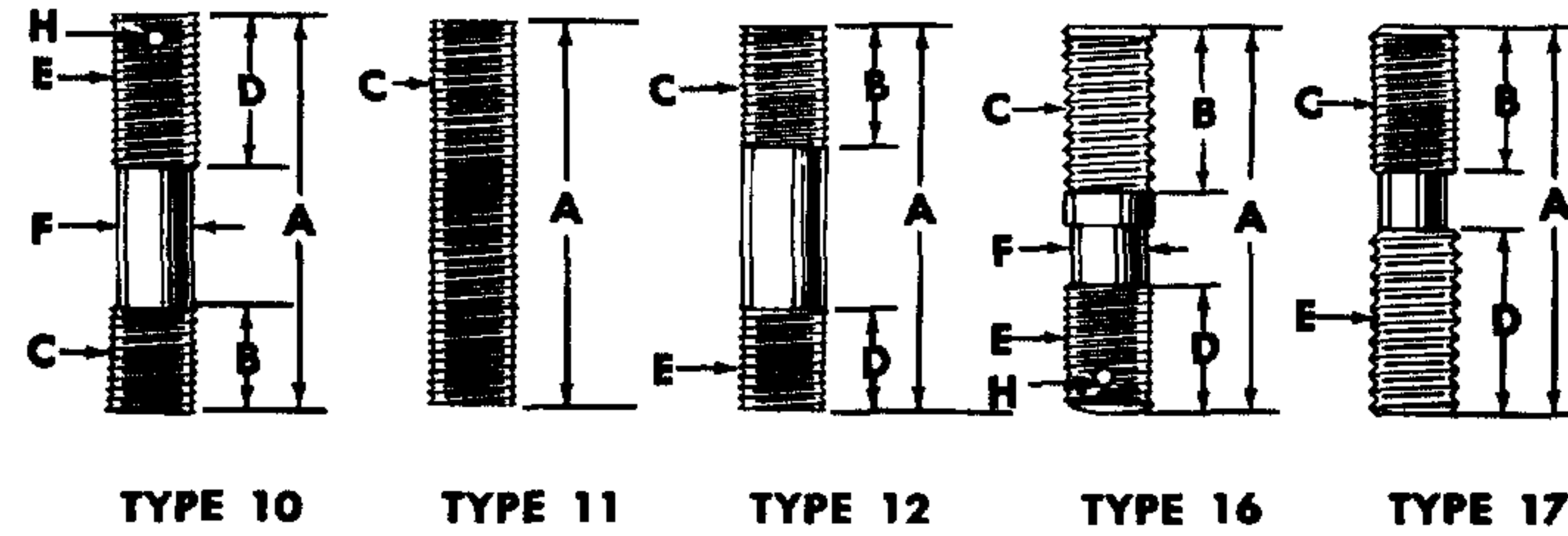

P-158

STUD CHART

PART NUMBER	TYPE	A	B	C	D	E	F	G	H
40 6065	2	2.34"	.64"	7/16"-20	.64"	7/16"-14			
52 6065	2	2.30"	.57"	3/8"-24	.64"	3/8"-16			
18 6066	4	2.78"	.62"	7/16"-20	.64"	7/16"-14	.40"	1.50"	
40 6066	4	2.90"	.62"	7/16"-20	.64"	7/16"-14	.40"	1.25"	
52 6066	2	2.74"	.57"	3/8"-24	.64"	3/8"-16			
40 6067	2	3.59"	.62"	7/16"-20	.62"	7/16"-14			
48 6067	4	3.09"	.62"	7/16"-20	.64"	7/16"-14	.40"	1.25"	
91A 6067	4	3.25"	.62"	7/16"-20	.64"	7/16"-14	.40"	1.25"	
40 6345	3	3.06"	1.10"	1/2"-20	.72"	1/2"-20	.48"	1.70"	9/64"
48 6345	3	3.06"	1.10"	1/2"-13	.72"	1/2"-20	.48"	1.70"	9/64"
68 6345	3	3.30"	1.10"	1/2"-13	.82"	1/2"-20	.48"	.78"	9/64"
52 6345-A	16	2.68"	1.02"	7/16"-14	.70"	7/16"-20	.42"		7/64"
9N 6345	3	2.84"	1.06"	1/2"-13	.75"	1/2"-20	.48"	.60"	1/8"
1GA 6345-B	3	3.34"	1.08"	1/2"-13	.76"	1/2"-20	.48"	.30"	9/64"
9N 6346	3	3.84"	1.06"	1/2"-13	.75"	1/2"-20	.48"	.60"	1/8"
1GA 6346-B	3	4.18"	1.08"	1/2"-13	.76"	1/2"-20	.48"	.30"	9/64"
18 6515	9	1.00"	.40"	5/16"-18	.37"	5/16"-24	.28"		
52 9454	2	1.40"	.62"	3/8"-16	.38"	3/8"-16			
A 24051-A	4	4.43"	.62"	7/16"-20	.71"	7/16"-14	.40"	1.75"	
A 24051-B	4	4.06"	.75"	7/16"-20	.71"	7/16"-14	.40"	1.75"	



CHASSIS PARTS CATALOGUE

STUD CHART

PART NUMBER	TYPE	A	B	C	D	E	F	G	H
88022-S	2	1.25"	.62"	3/8"-24	.50"	3/8"-16			
88367-S	2	1.18"	.43"	5/16"-24	.43"	5/16"-18			
88371-S	2	1.25"	.43"	5/16"-24	.43"	5/16"-18			
88377-S	2	1.31"	.62"	3/8"-24	.56"	3/8"-16			
88378-S	2	1.31"	.62"	7/16"-20	.50"	7/16"-14			
88386-S	2	1.43"	.50"	5/16"-24	.43"	5/16"-18			
88393-S	2	1.50"	.75"	7/16"-20	.50"	7/16"-14			
88389-S	2	1.56"	.75"	7/16"-20	.50"	7/16"-14			
88403-S	2	1.62"	.75"	7/16"-20	.50"	7/16"-14			
88422-S	2	1.87"	.62"	3/8"-24	.62"	3/8"-16			
88427-S	2	1.93"	.62"	3/8"-24	.62"	3/8"-16			
88442-S	2	2.12"	.75"	3/8"-24	.62"	3/8"-16			
88446-S	2	2.18"	.62"	5/16"-24	.50"	5/16"-18			
88448-S	2	2.18"	.75"	7/16"-20	.62"	7/16"-18			
88453-S	2	2.25"	.75"	7/16"-20	.62"	7/16"-18			
88507-S	2	2.93"	.75"	3/8"-24	.62"	3/8"-16			
88517-S	2	3.06"	.75"	3/8"-24	.62"	3/8"-16			
88531-S	2	3.25"	.62"	5/16"-24	.50"	5/16"-18			
89067-S	9	1.18"	.43"	5/16"-18	.43"	5/16"-24	.27"		
89101-S	9	1.62"	.50"	5/16"-18	.50"	5/16"-24	.27"		
89255-S	9	3.62"	.50"	5/16"-18	.75"	5/16"-24	.27"		
352675-S	12	1.38"	.58"	5/16"-18	.40"	5/16"-18			
352686-S	11	1.75"		3/8"-24					
352700-S	1	1.43"	.43"	3/8"-16	.62"	3/8"-24			
352706-S	11	1.50"		3/8"-24					
352725-S	4	3.50"	.81"	7/16"-20	.75"	7/16"-14	.43"	1.75"	
352726-S	4	3.68"	.75"	7/16"-20	.75"	7/16"-14	.43"	1.75"	
352727-S	4	5.71"	.62"	7/16"-20	.75"	7/16"-14	.43"	1.75"	
352728-S18	1	1.78"	.50"	7/16"-14	.63"	7/16"-20			
352731-S7	1	2.00"	.56"	5/8"-11	.81"	5/8"-18			
352740-S	17	2.62"	.80"	9/16"-18	.88"	9/16"-12			
357681-S	10	3.68"	.50"	5/16"-18	.75"	5/16"-24	.27"		7/64"
357692-S	1	1.50"	.50"	3/8"-16	.50"	3/8"-24			
357693-S	8	3.56"	.56"	3/8"-16	.88"	3/8"-24			1/8"
357730-S7	5	3.00"	1.24"	9/16"-18	.88"	9/16"-12			

MODEL IDENTIFICATION

MODEL	ENGINE		WHEELBASE	CHASSIS
	Cyl.	H.P.		

1928-31

A	4		103½"	Passenger
A	4		103½"	Commercial
AA	4		131½" & 157"	Truck

1932

B	4		106"	Passenger
B	4		106"	Commercial
BB	4		131½" & 157"	Truck
BB	8		131½" & 157"	Truck
18	8		106"	Passenger

1933-34

40	4		112"	Passenger
40	8		112"	Passenger
46	4		112"	Commercial
46	8		112"	Commercial
BB	4		131½" & 157"	Truck
BB	8		131½" & 157"	Truck

1935

48	8		112"	Passenger
50	8		112"	Commercial
51	8		131½" & 157"	Truck

1936

51	8		131½" & 157"	Truck
67	8		112"	Commercial
68	8		112"	Passenger

1937

73	8	60	112"	Commercial
74	8	60	112"	Passenger
75	8	60	131½"	Truck
77	8	85	112"	Commercial
78	8	85	112"	Passenger
79	8	85	131½" & 157"	Truck

1938

81A	8	90	112"	Passenger
81C	8	90	112"	Commercial
81T	8	90	134"	1½ Ton Truck
81U	8	90	134"	1½ Ton Dump Truck
81W	8	90	134"	1½ Ton C.O.E.
81Y	8	90	122"	1 Ton Truck
82A	8	60	112"	Passenger
82C	8	60	112"	Commercial
82Y	8	60	122"	1 Ton Truck
811T	8	90	191"	School Bus
811W	8	90	101"	1½ Ton C.O.E.
811Z	8	90	101"	1½ Ton C.O.E. Dump
817T	8	90	157"	1½ Ton Truck

MODEL	ENGINE		WHEELBASE	CHASSIS
	Cyl.	H.P.		

1939

91A	8	90	112"	Passenger
91C	8	90	112"	Commercial
91D	8	90	122"	¾ Ton Truck
91T	8	90	134"	1½ Ton Truck
91U	8	90	134"	1½ Ton Dump Truck
91W	8	90	134"	1½ Ton C.O.E.
91Y	8	90	122"	1 Ton Truck
92D	8	60	122"	¾ Ton Truck
92Y	8	60	122"	1 Ton Truck
99C	8	100	112"	Commercial
99D	8	100	122"	¾ Ton Truck
99T	8	100	134"	1½ Ton Truck
99U	8	100	134"	1½ Ton Dump Truck
99W	8	100	134"	1½ Ton C.O.E.
99Y	8	100	122"	1 Ton Truck
911T	8	90	191"	School Bus
911W	8	90	101"	1½ Ton C.O.E.
911Z	8	90	101"	1½ Ton C.O.E. Dump
917T	8	90	157"	1½ Ton Truck
917W	8	90	157"	1½ Ton C.O.E.
922A	8	60	112"	Passenger
922C	8	60	112"	Commercial
991W	8	100	101"	1½ Ton C.O.E.
991Z	8	100	101"	1½ Ton C.O.E. Dump
997T	8	100	157"	1½ Ton Truck
997W	8	100	157"	1½ Ton C.O.E.

1940

01A	8	90	112"	Passenger
01C	8	90	112"	Commercial
01D	8	90	122"	¾ Ton Truck
01T	8	90	134"	1½ Ton Truck
01U	8	90	134"	1½ Ton Dump Truck
01W	8	90	134"	1½ Ton C.O.E.
01Y	8	90	122"	1 Ton Truck
02D	8	60	122"	¾ Ton Truck
02Y	8	60	122"	1 Ton Truck
09C	8	100	112"	Commercial
09D	8	100	122"	¾ Ton Truck
09T	8	100	134"	1½ Ton Truck
09U	8	100	134"	1½ Ton Dump Truck
09W	8	100	134"	1½ Ton C.O.E.
09Y	8	100	122"	1 Ton Truck
011W	8	90	101"	1½ Ton C.O.E.
014T	8	90	194"	School Bus
018T	8	90	158"	1½ Ton Truck
018W	8	90	158"	1½ Ton C.O.E.
022A	8	60	112"	Passenger
022C	8	60	112"	Commercial
091W	8	100	101"	1½ Ton C.O.E.
094T	8	100	194"	School Bus
098T	8	100	158"	1½ Ton Truck
098W	8	100	158"	1½ Ton C.O.E.

MODEL IDENTIFICATION (Cont'd)

MODEL	ENGINE		WHEELBASE	CHASSIS
	Cyl.	H.P.		
1941				
11A	8	90	114"	Passenger
11C	8	90	112"	Commercial
11D	8	90	122"	¾ Ton Truck
11T	8	90	134"	1½ Ton Truck
11U	8	90	134"	1½ Ton Dump Truck
11W	8	90	134"	1½ Ton C.O.E.
11Y	8	90	122"	1 Ton Truck
19C	8	100	112"	Commercial
19D	8	100	122"	¾ Ton Truck
19T	8	100	134"	1½ Ton Truck
19U	8	100	134"	1½ Ton Dump Truck
19W	8	100	134"	1½ Ton C.O.E.
19Y	8	100	122"	1 Ton Truck
111W	8	90	101"	1½ Ton C.O.E.
114T	8	90	194"	School Bus
118T	8	90	158"	1½ Ton Truck
118W	8	90	158"	1½ Ton C.O.E.
191W	8	100	101"	1½ Ton C.O.E.
194T	8	100	194"	School Bus
198T	8	100	158"	1½ Ton Truck
198W	8	100	158"	1½ Ton C.O.E.
1GA	6	90	114"	Passenger
1GC	6	90	112"	Commercial
1GD	6	90	122"	¾ Ton Truck
1GT	6	90	134"	1½ Ton Truck
1GU	6	90	134"	1½ Ton Dump Truck
1GY	6	90	122"	1 Ton Truck
1G4T	6	90	194"	School Bus
1G8T	6	90	158"	1½ Ton Truck
1NC	4	40	112"	Commercial
1ND	4	40	122"	¾ Ton Truck
1NY	4	40	122"	1 Ton Truck

1942				
21A	8	90	114"	Passenger
21C	8	90	114"	Light Truck (Commercial)
21D	8	90	122"	¾ Ton Truck
21T	8	90	134"	1½ Ton Truck
21U	8	90	134"	1½ Ton Dump Truck
21W	8	90	134"	1½ Ton C.O.E.
21Y	8	90	122"	1 Ton Truck
29C	8	100	114"	Light Truck (Commercial)
29D	8	100	122"	¾ Ton Truck
29T	8	100	134"	1½ Ton Truck
29U	8	100	134"	1½ Ton Dump Truck
29W	8	100	134"	1½ Ton C.O.E.
29Y	8	100	122"	1 Ton Truck
211W	8	90	101"	1½ Ton C.O.E.
214T	8	90	194"	School Bus
218T	8	90	158"	1½ Ton Truck
218W	8	90	158"	1½ Ton C.O.E.
291W	8	100	101"	1½ Ton C.O.E.
294T	8	100	194"	School Bus
298T	8	100	158"	1½ Ton Truck
298W	8	100	158"	1½ Ton C.O.E.
2GA	6	90	114"	Passenger
2GC	6	90	114"	Light Truck (Commercial)
2GD	6	90	122"	¾ Ton Truck
2GT	6	90	134"	1½ Ton Truck
2GU	6	90	134"	1½ Ton Dump Truck
2GY	6	90	122"	1 Ton Truck
2G4T	6	90	194"	School Bus
2G8T	6	90	158"	1½ Ton Truck
2NC	4	40	114"	Light Truck (Commercial)
2ND	4	40	122"	¾ Ton Truck
2NY	4	40	122"	1 Ton Truck

MODEL	ENGINE		WHEELBASE	CHASSIS
	Cyl.	H.P.		
1944				
494T	8	100	194"	School Bus
498T	8	100	158"	1½ Ton Truck
1945				
59C	8	100	114"	Light Truck (Commercial)
59T	8	100	134"	1½ Ton Truck
594T	8	100	194"	School Bus
598T	8	100	158"	1½ Ton Truck
1946				
69A	8	100	114"	Passenger
69C	8	100	114"	Light Truck (Commercial)
69D	8	100	122"	¾ Ton Truck
69T	8	100	134"	1½ Ton Truck
69U	8	100	134"	1½ Ton Dump Truck
69W	8	100	134"	1½ Ton C.O.E.
69Y	8	100	122"	1 Ton Truck
691W	8	100	101"	1½ Ton C.O.E.
694T	8	100	194"	School Bus
698T	8	100	158"	1½ Ton Truck
698W	8	100	158"	1½ Ton C.O.E.
6GA	6	90	114"	Passenger
6GC	6	90	114"	Light Truck (Commercial)
6GD	6	90	122"	¾ Ton Truck
6GT	6	90	134"	1½ Ton Truck
6GU	6	90	134"	1½ Ton Dump Truck
6GY	6	90	122"	1 Ton Truck
6G4T	6	90	194"	1½ Ton Truck
6G8T	6	90	158"	1½ Ton Truck

1947				
79A	8	100	114"	Passenger
79C	8	100	114"	Light Truck (Commercial)
79D	8	100	122"	¾ Ton Truck
79T	8	100	134"	1½ Ton Truck
79W	8	100	134"	1½ Ton C.O.E.
79Y	8	100	122"	1 Ton Truck
791W	8	100	101"	1½ Ton C.O.E.
794T	8	100	194"	School Bus
798T	8	100	158"	1½ Ton Truck
798W	8	100	158"	1½ Ton C.O.E.
7GA	6	90	114"	Passenger
7GC	6	90	114"	Light Truck (Commercial)
7GD	6	90	122"	¾ Ton Truck
7GT	6	90	134"	1½ Ton Truck
7GY	6	90	122"	1 Ton Truck
7G4T	6	90	194"	School Bus
7G8T	6	90	158"	1½ Ton Truck
7HA	6	95	114"	Passenger
7HC	6	95	114"	Light Truck (Commercial)
7HD	6	95	122"	¾ Ton Truck
7HT	6	95	134"	1½ Ton Truck
7HY	6	95	122"	1 Ton Truck
7H4T	6	95	194"	School Bus
7H8T	6	95	158"	1½ Ton Truck

1948				
89A	8	100	114"	Passenger
8HA	6	95	114"	Passenger

1928-1929

FORD PASSENGER, COMMERCIAL AND TRUCK MODELS

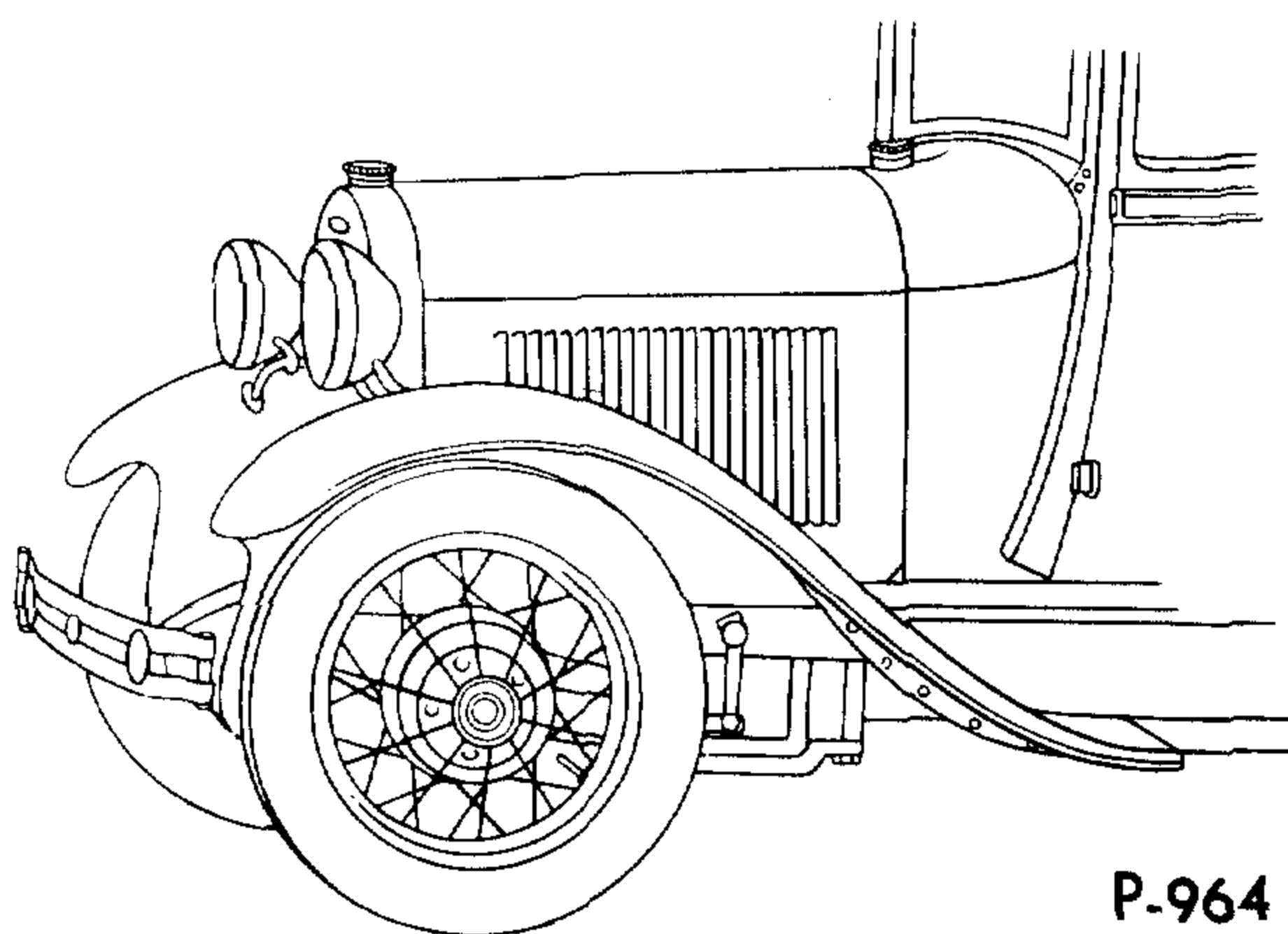
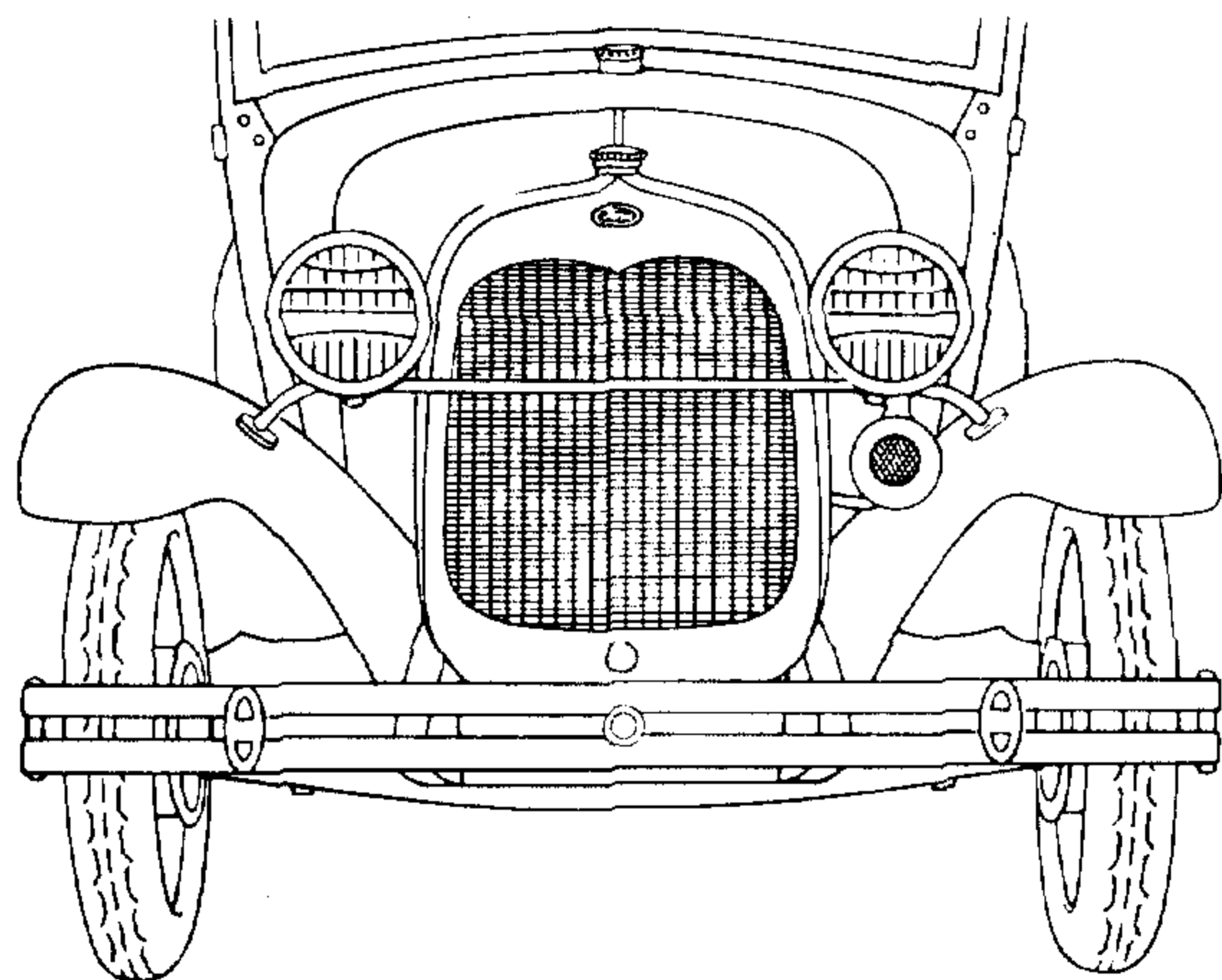

P-964

MODEL A FORD PASSENGER AND COMMERCIAL CARS—4 Cylinder Engine
(103½" Wheelbase)

MODEL AA FORD TRUCK—4 Cylinder Engine
(131½" Wheelbase)

BODY TYPE	NAME	YEAR	BODY TYPE	NAME	YEAR
PASSENGER					
35-A	Phaeton (Std.)	1928-29	60-C	Fordor Sedan (steel back) (Briggs)	1929
40-A	Roadster (Std.)	1928-29	68-A	Cabriolet	1929
45-A	Coupe (Std.)	1928-29	140-A	Town Car	1928-29
49-A	Coupe (Special)	1928-29	150-A	Station Wagon	1928-29
50-A	Coupe (Sport)	1928-29	155-A	Town Sedan (Murray)	1929
54-A	Coupe (Business)	1928-29	155-B	Town Sedan (Briggs)	1929
55-A	Tudor Sedan	1928-29	165-A	Fordor Sedan (Std.) (Murray)	1929
60-A	Fordor Sedan (leather back—seal brown top) (Briggs)	1928-29	165-B	Fordor Sedan (Std.) (Briggs)	1929
60-B	Fordor Sedan (leather back—black top) (Briggs)	1929	170-A	Fordor Sedan (Std.) (2 Window)	1929
			170-B	Fordor Sedan (Std.) (2 Window)	1929
COMMERCIAL AND TRUCKS					
76-A	Cab (Open)	1928-29	88-A	Platform	1928-29
78-A	Pickup	1928-29	89-A	Express	1928-29
79-A	Panel Delivery (103½" Wheelbase)	1928-29	130-A	De Luxe Delivery	1928-29
82-A	Cab (Closed)	1928-29	135-A	Taxicab	1928-29
85-A	Panel Delivery (131½" Wheelbase)	1928-29	188-A	Stake (131½" Wheelbase)	1928-29

1930

FORD PASSENGER, COMMERCIAL AND TRUCK MODELS

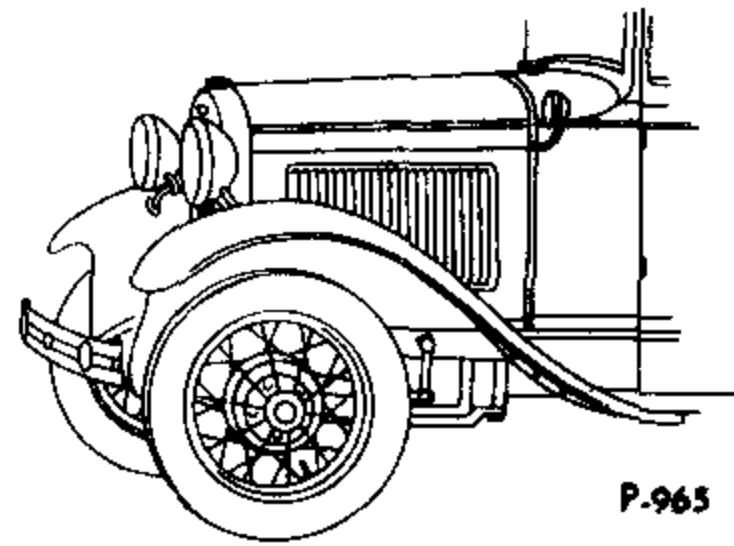
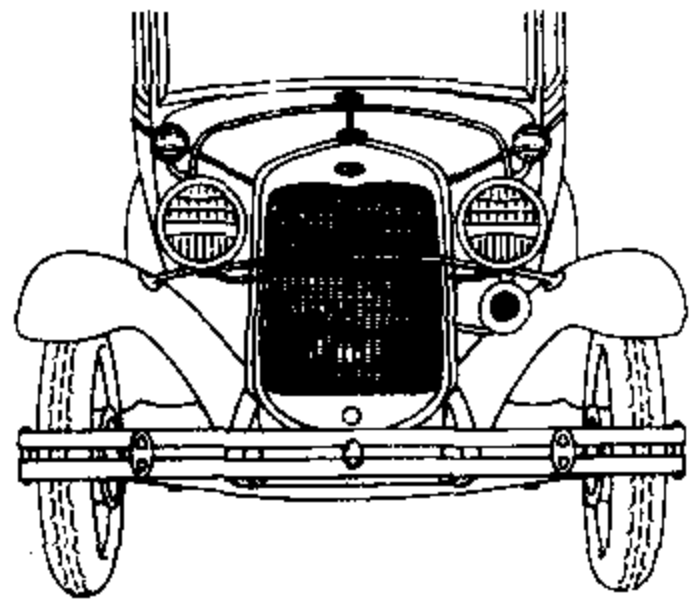

P.965

MODEL A FORD PASSENGER CAR
4 Cylinder Engine (103½" Wheelbase)

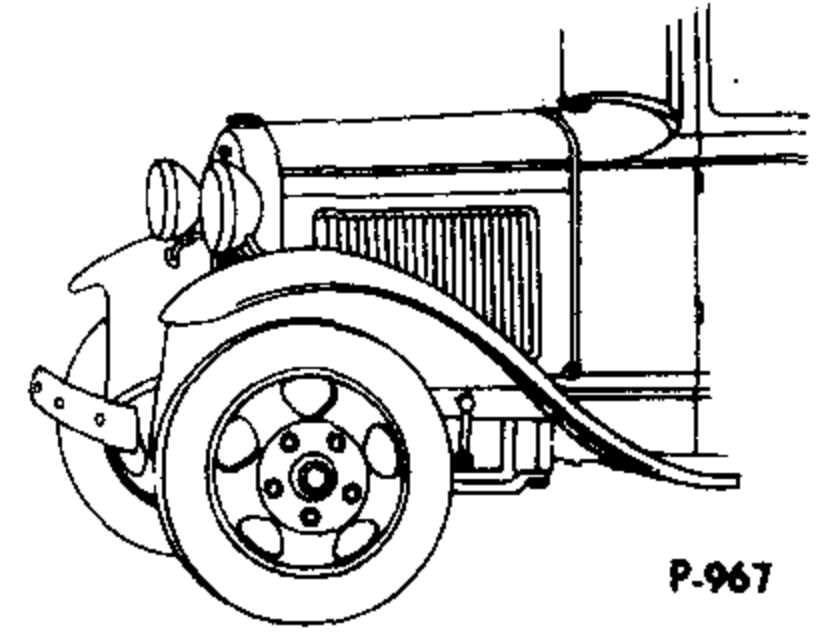
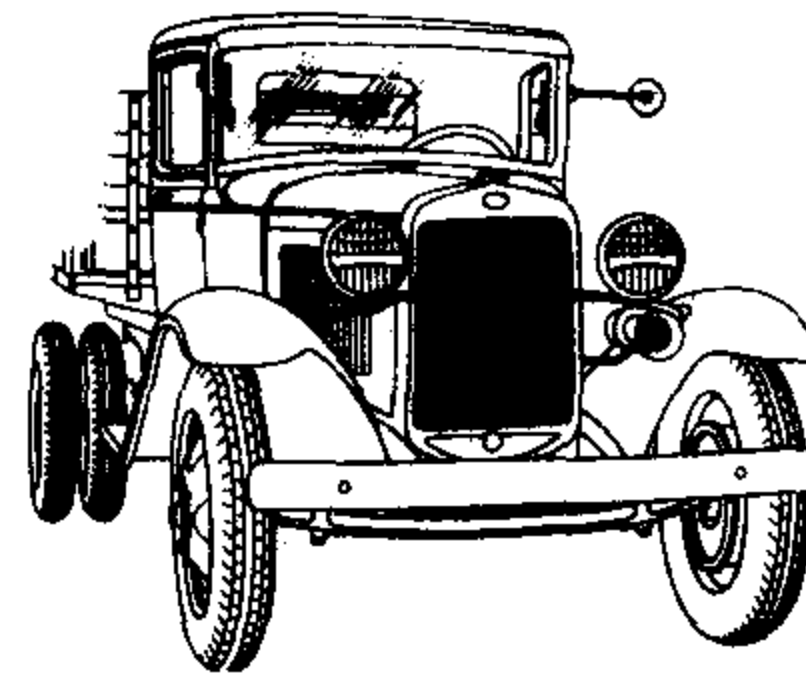

P.967

MODEL AA FORD TRUCK
4 Cylinder Engine (131½" and 157" Wheelbase)

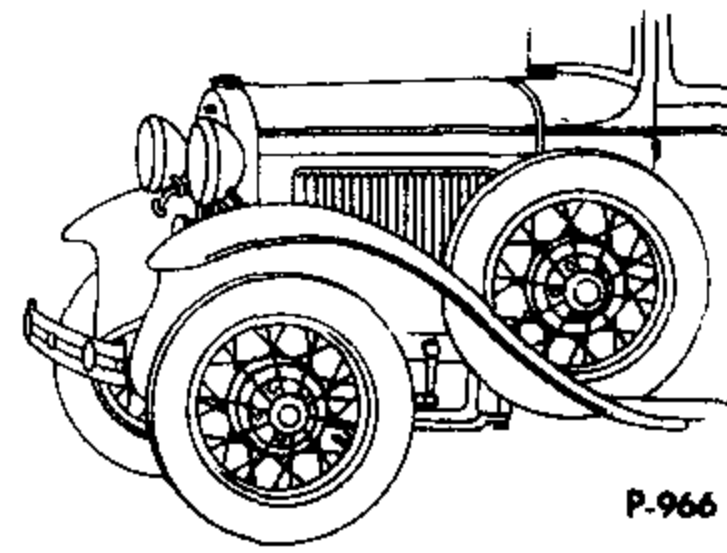
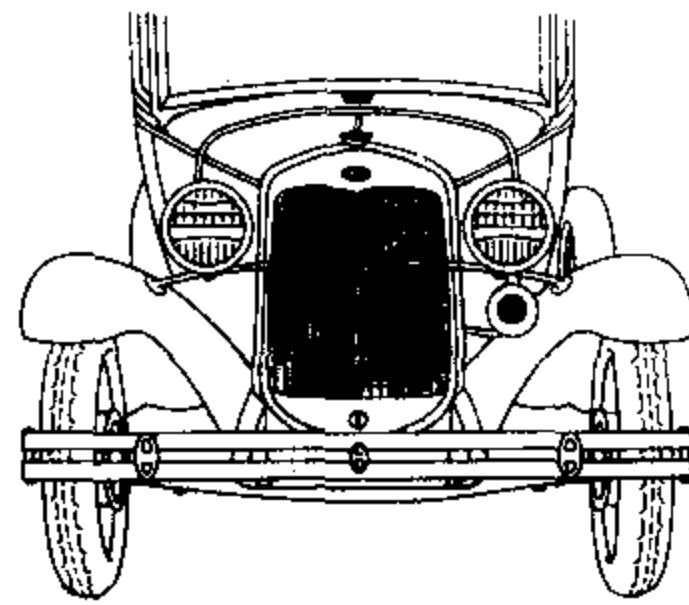

P.966

MODEL A FORD COMMERCIAL—4 Cylinder Engine
(103½" Wheelbase)

BODY TYPE	NAME	BODY TYPE	NAME
PASSENGER			
35-B	Phaeton (Standard)	155-C	Town Sedan (Murray)
40-B	Roadster (Standard)	155-D	Town Sedan (Briggs)
40-B	Roadster (De Luxe)	165-C	Fordor Sedan (Standard) (Murray)
45-B	Coupe (Standard)	165-D	Fordor Sedan (Standard) (Briggs)
45-B	Coupe (De Luxe)	170-B	Fordor Sedan (Standard) (2 Window)
50-B	Coupe (Sport)	170-B	Fordor Sedan (De Luxe) (2 Window)
55-B	Tudor Sedan	180-A	Phaeton (De Luxe)
68-B	Cabriolet	190-A	Victoria
COMMERCIAL AND TRUCK			
76-A	Cab (Open)	202-A	Gravity dump body assembly (Anthony)
76-B	Cab (Open)	203-A	Garbage body with heavy hydraulic hoist (2 cu. yd. capacity) (Galion)
78-A	Pickup	203-B	Garbage body with heavy hydraulic hoist (2 cu. yd. capacity) (Wood)
79-A	"A" Panel Delivery	203-C	Garbage body with heavy hydraulic hoist (3 cu. yd. capacity) (Galion)
79-B	"A" Panel Delivery	203-D	Garbage body with heavy hydraulic hoist (3 cu. yd. capacity) (Wood)
82-A	Cab (Closed)	204-A	Dump body with light hydraulic hoist (1½ cu. yd. capacity) (Galion)
82-B	Cab (Closed)	204-B	Dump body with light hydraulic hoist (1½ cu. yd. capacity) (Wood)
85-A	"A" Panel Delivery	205-A	Hi-Lift Hydraulic Coal Body (72 cu. ft.) (Wood)
85-B	"AA" Panel Delivery	206-A	Dump body with Rotary power hoist (Anthony)
88-A	Platform	207-B	Combined dump and coal body with high sides and end gate with chute opening and swinging partition with heavy hydraulic hoist (1½ cu. yd. capacity) (120 cu. ft. with top boards)
89-A	Express	208-A	Dump body with heavy hydraulic hoist (1½ cu. yd. capacity) (Galion)
130-A	De Luxe Delivery	208-B	Dump body with heavy hydraulic hoist (1½ cu. yd. capacity) (Wood)
130-B	De Luxe Delivery (drop floor)	225-A	"A" Panel Delivery (with drop floor)
130-B	De Luxe Delivery (Standard)	236-A	Light hydraulic hoist and body understructure (Galion)
150-B	Station Wagon	237-A	Heavy hydraulic hoist and body understructure (Galion)
185-A	Platform (157" Wheelbase)		
186-A	Stake (157" Wheelbase)		
188-A	Stake (131½" Wheelbase)		
200-A	Hand hoist dump body assembly (Anthony)		
201-A	Coal body, with heavy hydraulic hoist and end gate with chute (less swinging partition) (75 cu. ft.) (Galion)		
201-B	Coal body with heavy duty hydraulic hoist, swinging partition and end gate with chute (high end) (75 cu. ft. or 120 cu. ft. with sides) (Wood)		
201-C	Coal body with heavy duty hydraulic hoist and end gate with chute (less swinging partition) (75 cu. ft.) (Wood)		

1931

FORD PASSENGER CAR MODELS

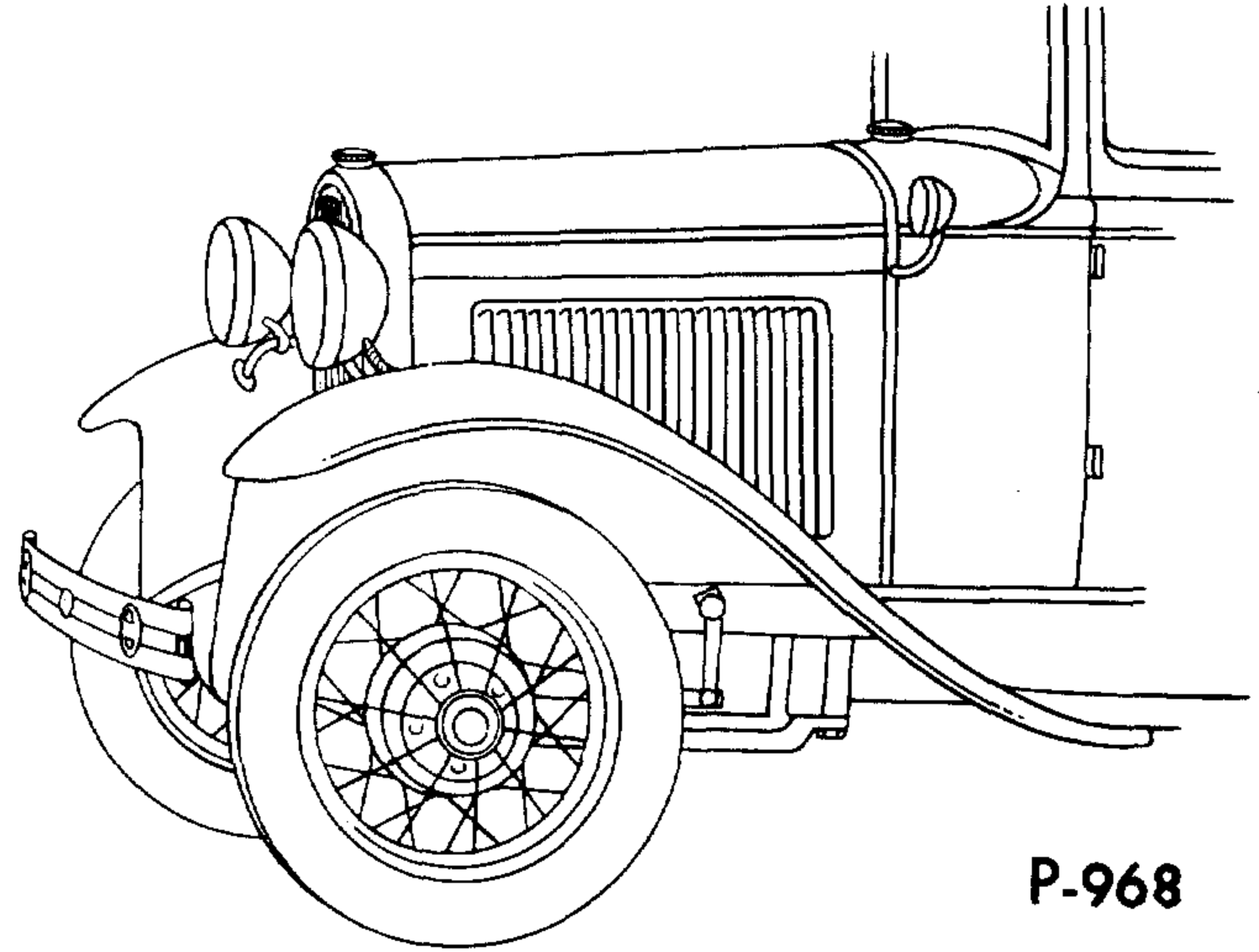
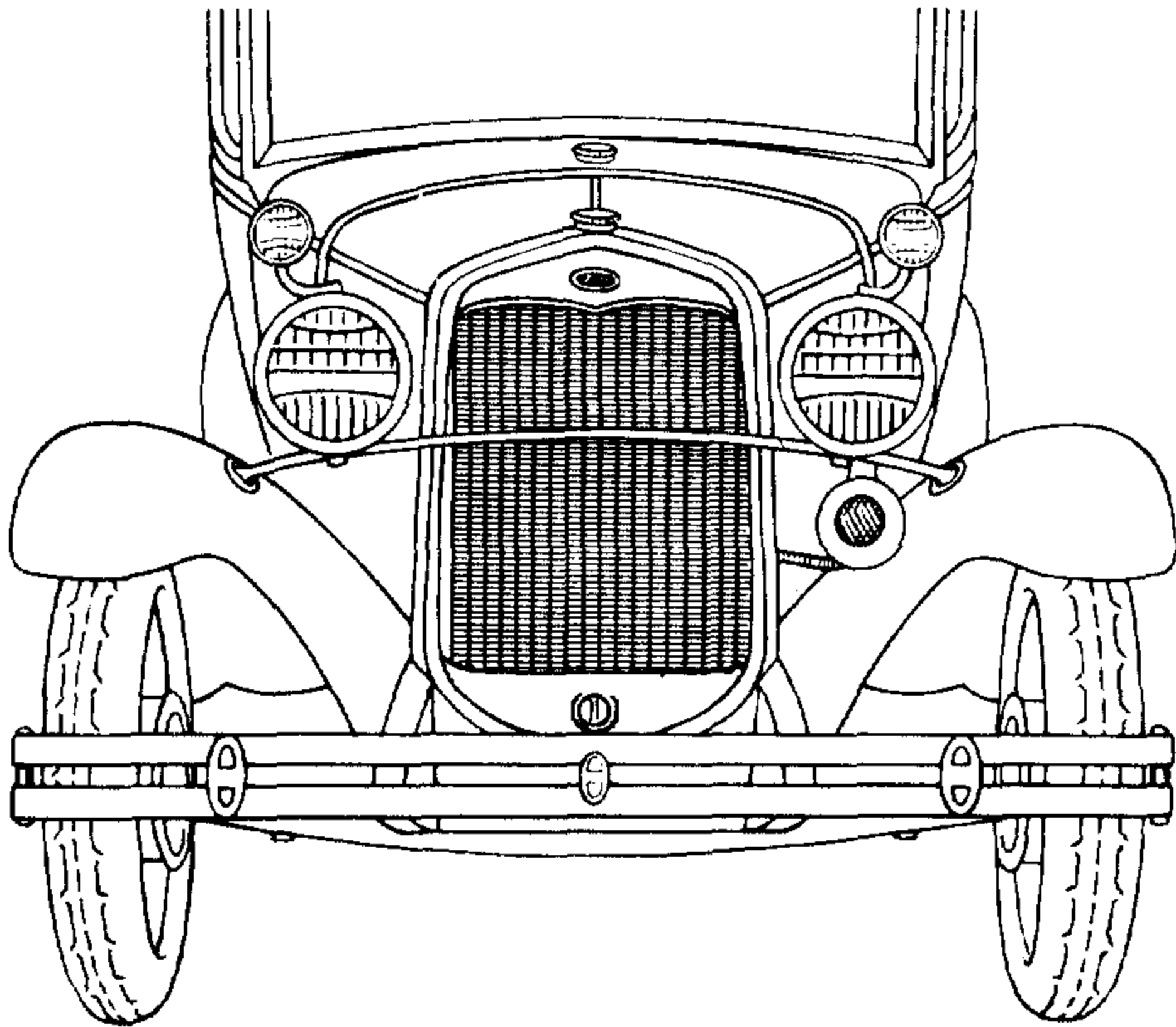

P-968

MODEL A FORD PASSENGER CAR—4 Cylinder Engine
(103½" Wheelbase)

BODY TYPE	NAME	BODY TYPE	NAME
35-B	Phaeton (Standard)	155-C	Town Sedan (Murray)
40-B	Roadster (Standard)	155-D	Town Sedan (Briggs)
40-B	Roadster (De Luxe)	160-A	Fordor Sedan (Standard)
45-B	Coupe (Standard)	160-B	Town Sedan
45-B	Coupe (De Luxe)	160-C	Fordor Sedan (De Luxe)
50-B	Coupe (Sport)	165-C	Fordor Sedan (Standard) (Murray)
55-B	Tudor Sedan	165-D	Fordor Sedan (Standard) (Briggs)
68-B	Cabriolet	170-B	Fordor Sedan (De Luxe) (2 Window)
68-C	Cabriolet	180-A	Phaeton (De Luxe)
		190-A	Victoria

1931

FORD COMMERCIAL AND TRUCK MODELS

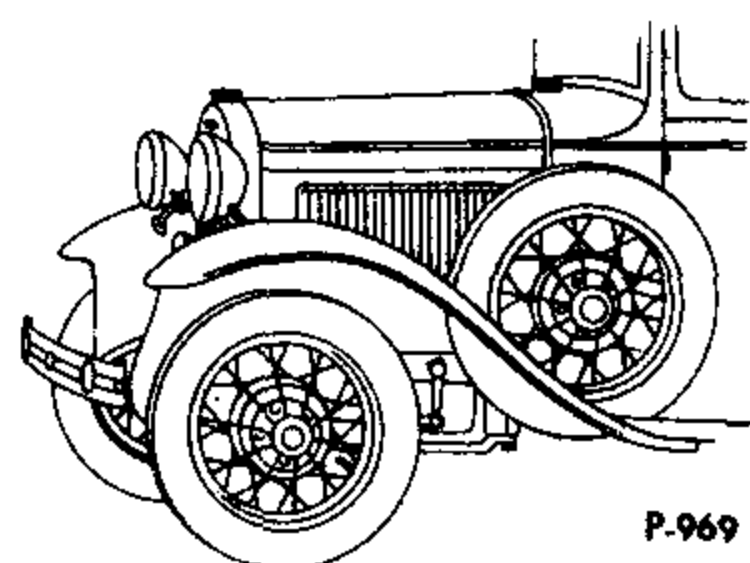
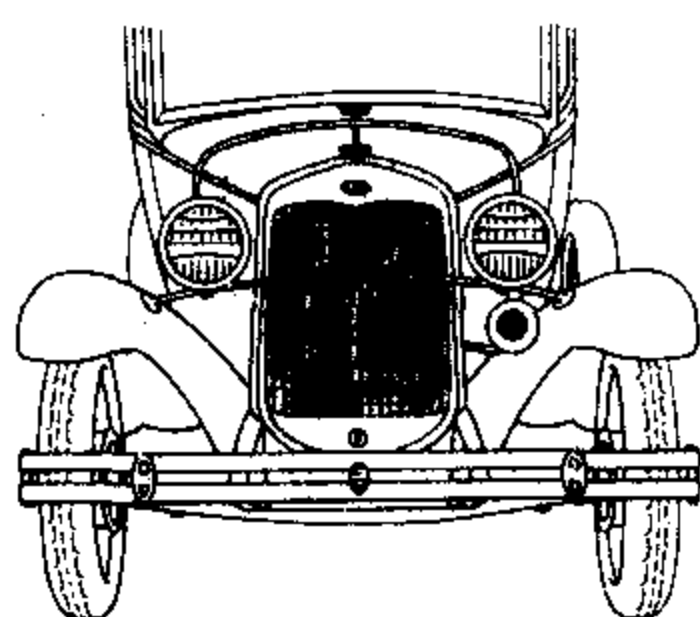

P-969

MODEL A FORD COMMERCIAL—4 Cylinder Engine
(103½" Wheelbase)

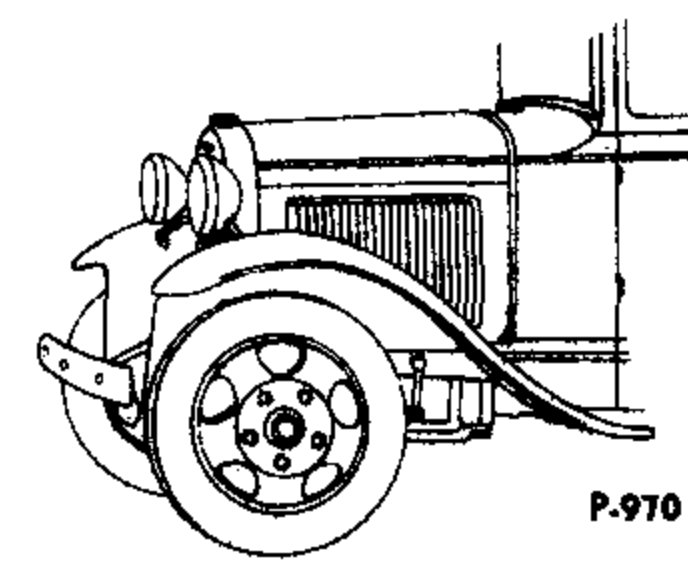
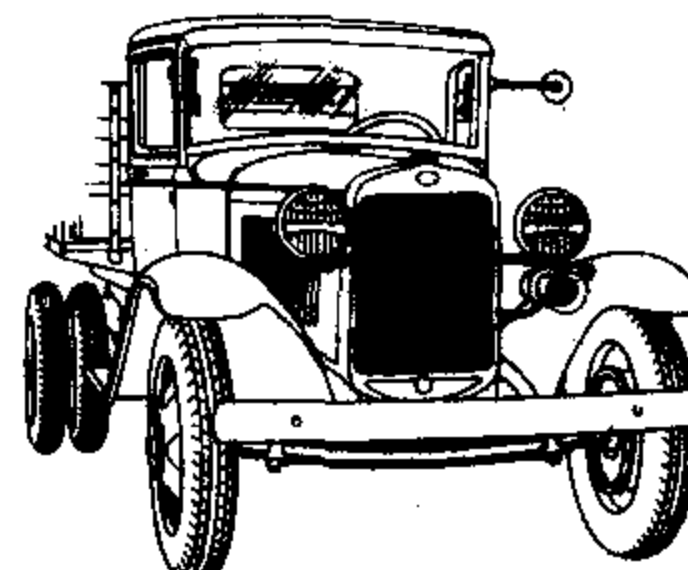

P-970

MODEL AA FORD TRUCK—4 Cylinder Engine
(131½" and 157" Wheelbase)

BODY TYPE	N A M E	BODY TYPE	N A M E
65-A	Canopy and Screens (Used with Type 78-B)	204-B	Dump body with light hydraulic hoist (1½ cu. yd. capacity) (Wood)
66-A	De Luxe Pickup	205-A	Hi-Lift Hydraulic Coal Body (72 cu. ft.) (Wood)
76-B	Cab (Open)	206-B	Dump body with mechanical hoist (1½ cu. yd. capacity) (Detwiller)
78-A	Pickup	207-B	Combined dump and coal body with high sides and end gate with chute opening and swinging partition (1½ cu. yd. capacity) (120 cu. ft. with top boards)
78-B	Pickup	208-A	Dump body with heavy hydraulic hoist (1½ cu. yd. capacity) (Galion)
79-A	Panel Delivery (103½" Wheelbase)	208-B	Dump body with heavy hydraulic hoist (1½ cu. yd. capacity) (Wood)
79-B	Panel Delivery (103½" Wheelbase)	210-A	"AA" Panel Delivery
82-B	Cab (Closed)	225-A	"A" Panel Delivery (with drop floor)
85-B	Panel Delivery (131½" Wheelbase)	228-A	Stock Racks
130-B	De Luxe Delivery (Drop Floor)	229-A	Service Car
130-B	De Luxe Delivery (Standard)	236-A	Light hydraulic hoist and body understructure (Galion)
150-B	Station Wagon	236-B	Light hydraulic hoist and body understructure
185-B	Platform (157" Wheelbase)	237-A	Heavy hydraulic hoist and body understructure (Galion)
186-B	Stake (157" Wheelbase)	237-B	Heavy hydraulic hoist and body understructure (Wood)
187-A	Platform (131½" Wheelbase)	238-A	Stock Racks (157" Wheelbase)
189-A	Stake (131½" Wheelbase)	239-A	Meat Packers Express
195-A	Express Body (131½" Wheelbase)	242-A	Heavy Duty Express Body (131½" Wheelbase)
196-A	Canopy Top and Screens (For 195-A)	244-A	Grain body with or without stock rack or grain side extensions (157" Wheelbase)
197-A	Express Body (157" Wheelbase)	248-A	Grain body with or without stock rack or grain side extensions (131½" Wheelbase)
198-A	Canopy Top and Screens (For 197-A)	255-A	Special Delivery (Natural Wood)
199-A	Ice Wagon	270-A	Funeral Service
200-B	Dump Body with hand hoist (1½ cu. yd. capacity) (Galion)	275-A	Funeral Coach
201-A	Coal body with heavy hydraulic hoist and end gate with chute (less swinging partition) (75 cu. ft.) (Galion)	280-A	Ambulance
201-B	Coal body with heavy duty hydraulic hoist, swinging partition and end gate with chute (high end) (75 cu. ft. or 120 cu. ft. with sides) (Wood)	285-A	Police, Patrol (De Luxe)
201-C	Coal body with heavy duty hydraulic hoist and end gate with chute (less swinging partition) (75 cu. ft.) (Wood)	290-A	Police Patrol (Standard)
202-B	Gravity dump body (1½ cu. yd. capacity) (Wood)	295-A	Town Car Delivery
203-A	Garbage body with heavy hydraulic hoist (2 cu. yd. capacity) (Galion)	300-A	De Luxe Delivery
203-B	Garbage body with heavy hydraulic hoist (2 cu. yd. capacity) (Wood)	315-A	Standrive
203-C	Garbage body with heavy hydraulic hoist (3 cu. yd. capacity) (Galion)	330-A	School and Passenger Bus
203-D	Garbage body with heavy hydraulic hoist (3 cu. yd. capacity) (Wood)	400-A	Convertible Sedan
204-A	Dump body with light hydraulic hoist (1½ cu. yd. capacity) (Galion)		

1932

FORD PASSENGER, COMMERCIAL AND TRUCK MODELS

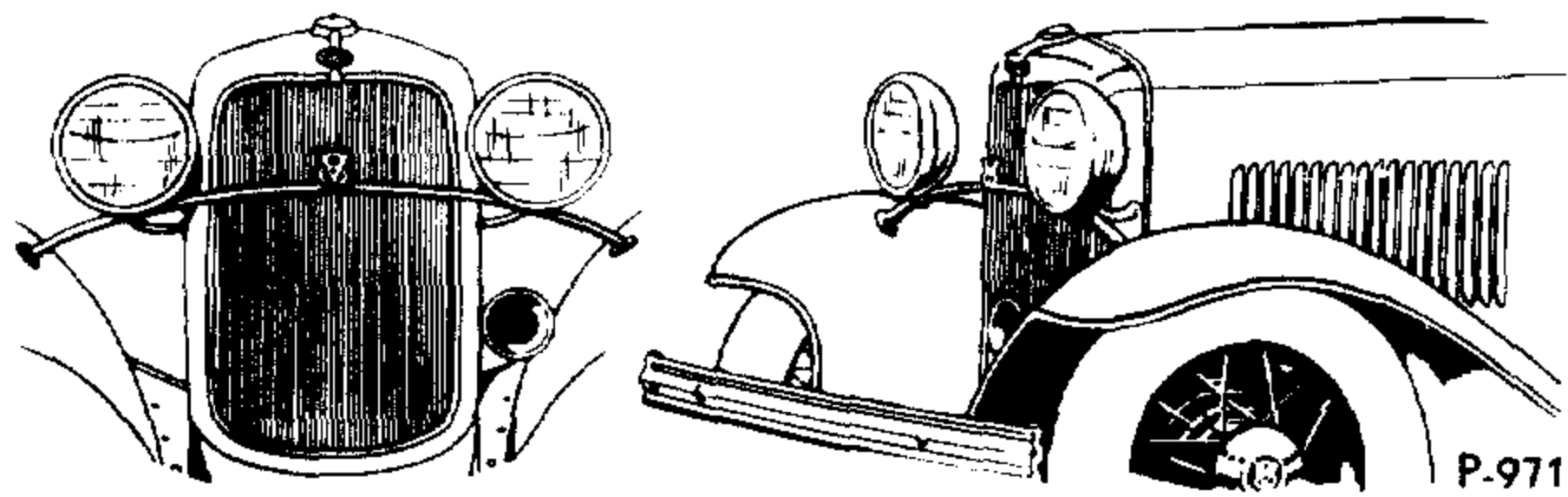

MODEL 18 FORD PASSENGER CAR
8 Cylinder Engine (106" Wheelbase)

MODEL B FORD PASSENGER CAR
4 Cylinder Engine (106" Wheelbase)

(Illustration is 8-Cylinder model; 4-Cylinder is the same excepting V-8 ornaments)

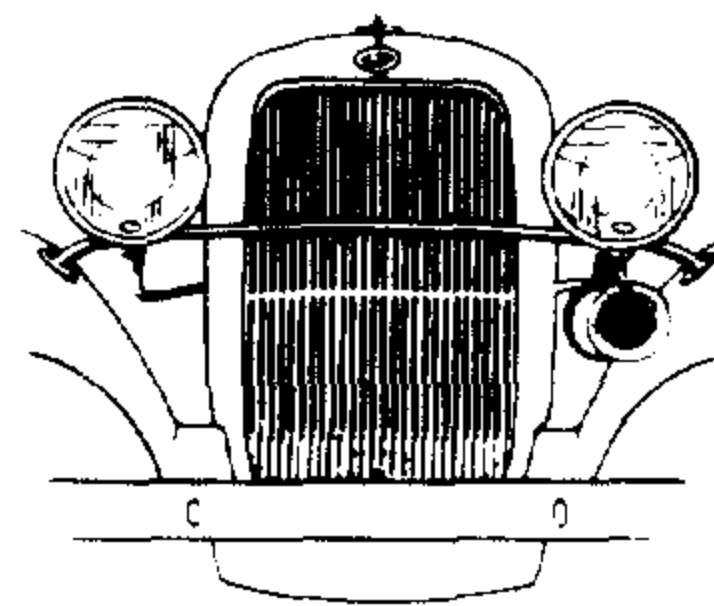

MODEL BB FORD TRUCK

8 Cylinder Engine (131½" and 157" Wheelbase)

4 Cylinder Engine (131½" and 157" Wheelbase)

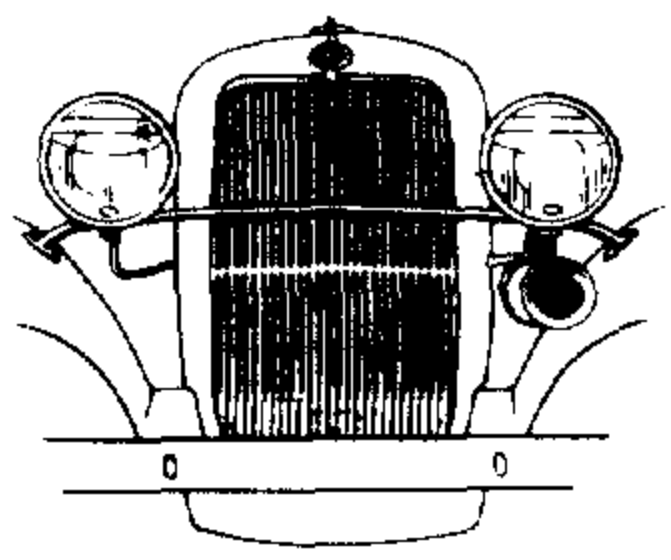

MODEL B FORD COMMERCIAL

8 Cylinder Engine—(106" Wheelbase)

4 Cylinder Engine—(106" Wheelbase)

(Illustration is 4-Cylinder model; 8-Cylinder is the same with V-8 ornaments)

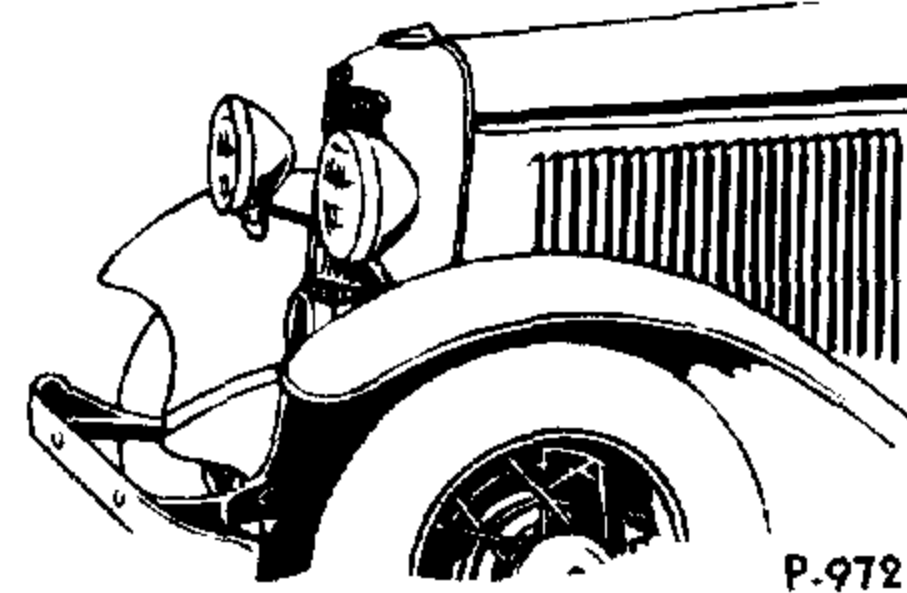

BODY TYPE	NAME	BODY TYPE	NAME
PASSENGER			
35	Phaeton (Standard)	55	Tudor Sedan (De Luxe)
35	Phaeton (De Luxe)	68	Cabriolet
40	Roadster (Standard)	160	Fordor Sedan (Standard)
40	Roadster (De Luxe)	160	Fordor Sedan (De Luxe)
45	Coupe (Standard)	190	Victoria
50	Coupe (Sport)	400	Convertible Sedan
55	Tudor Sedan (Standard)	520	Coupe (De Luxe)
COMMERCIAL AND TRUCK			
76	Open Cab	204-B	Dump body assembly—complete with hydraulic hoist—without body running board (1½ cu. yd. capacity) (Wood)
78	Pickup	206	Dump body with mechanical hoist (1½ cu. yd. capacity)
79	Panel Delivery (Standard) (106" Wheelbase)	208-A	Dump body assembly—complete with hydraulic hoist—without body running board (1½ cu. yd. capacity) (Galion)
79	Panel Delivery (De Luxe) (106" Wheelbase)	208-B	Dump body assembly—complete with hydraulic hoist—with body running board (1½ cu. yd. capacity) (Galion)
82	Closed Cab	210	Panel Delivery (157" Wheelbase)
85	Panel Delivery (Standard) (131½" Wheelbase)	228-A	Stock Racks
85	Panel Delivery (De Luxe) (131½" Wheelbase)	238-A	Stock Racks (157" Wheelbase)
150	Station Wagon	242-A	Heavy duty express body (131½" Wheelbase)
185-B	Platform (157" Wheelbase)	244-A	Grain body with or without stock rack or grain side extensions (157" Wheelbase)
186-B	Stake (157" Wheelbase)	248-A	Grain body with or without stock rack or grain side extensions (131½" Wheelbase)
187-A	Platform (131½" Wheelbase)	315-A	Standrive
189-A	Stake (131½" Wheelbase)	330-A	School and Passenger Bus
195	Express Body (131½" Wheelbase)	330	School and Passenger Bus
197	Express Body (157" Wheelbase)	410	Sedan Delivery
199-A	Ice Wagon		
200	Dump body assembly—complete with hand hoist (1½ cu. yd. capacity)		
202	Gravity dump body assembly—complete (1½ cu. yd. capacity)		
204-A	Dump body assembly—complete with hydraulic hoist—without body running board (1½ cu. yd. capacity) (Wood)		

1933

FORD PASSENGER, COMMERCIAL AND TRUCK MODELS

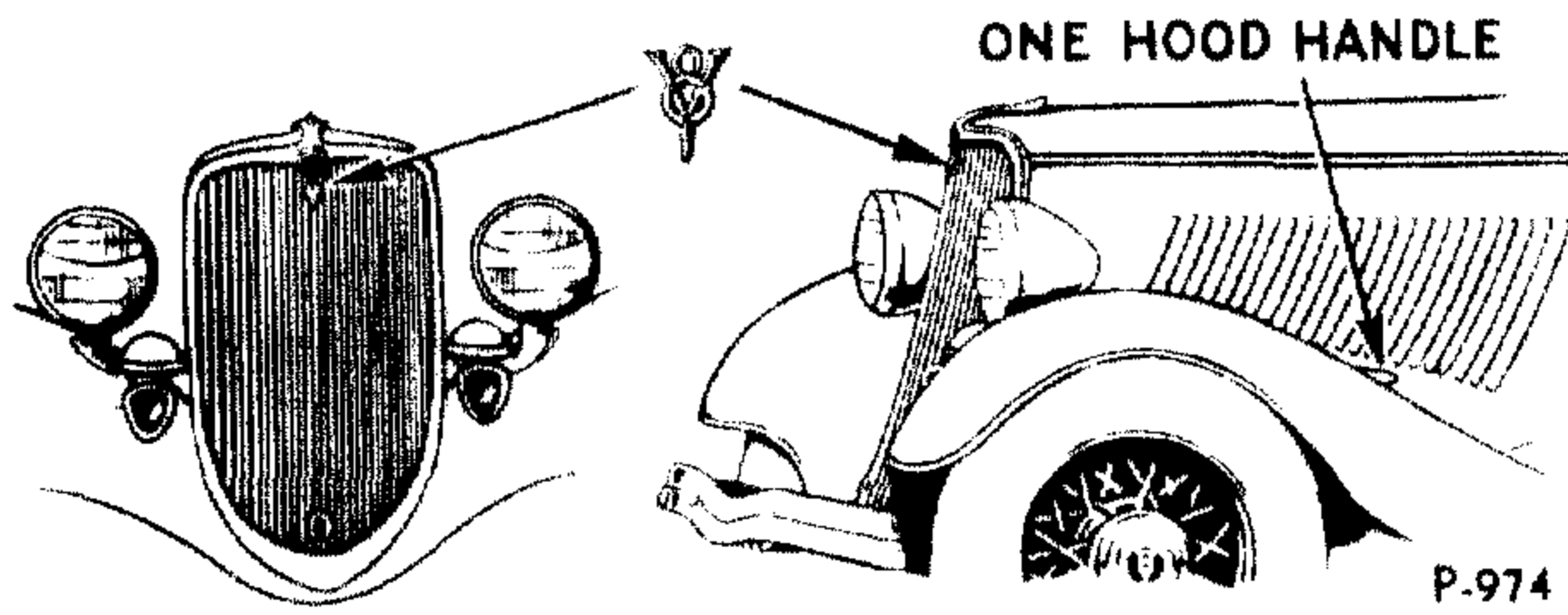

MODEL 40 FORD PASSENGER CAR
8 Cylinder Engine (112" Wheelbase)
4 Cylinder Engine (112" Wheelbase)
(Illustration is 8-Cylinder model; 4-Cylinder is the same excepting V-8 ornaments)

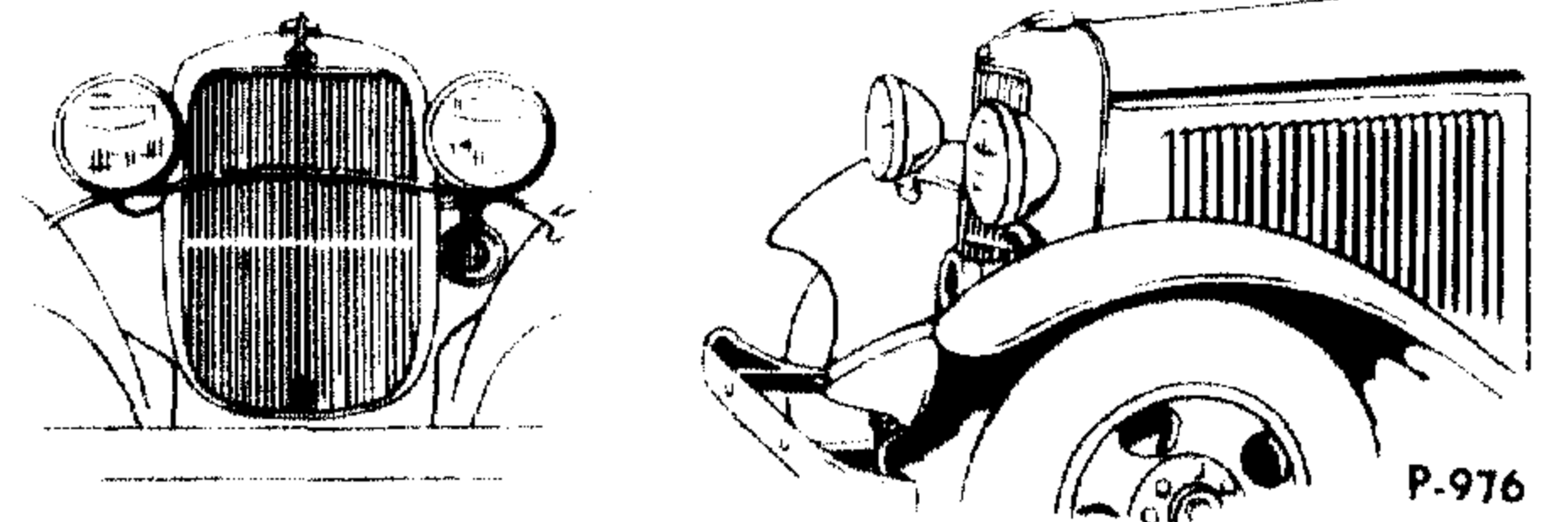

MODEL BB FORD TRUCK
8 Cylinder Engine (131½" and 157" Wheelbase)
4 Cylinder Engine (131½" and 157" Wheelbase)

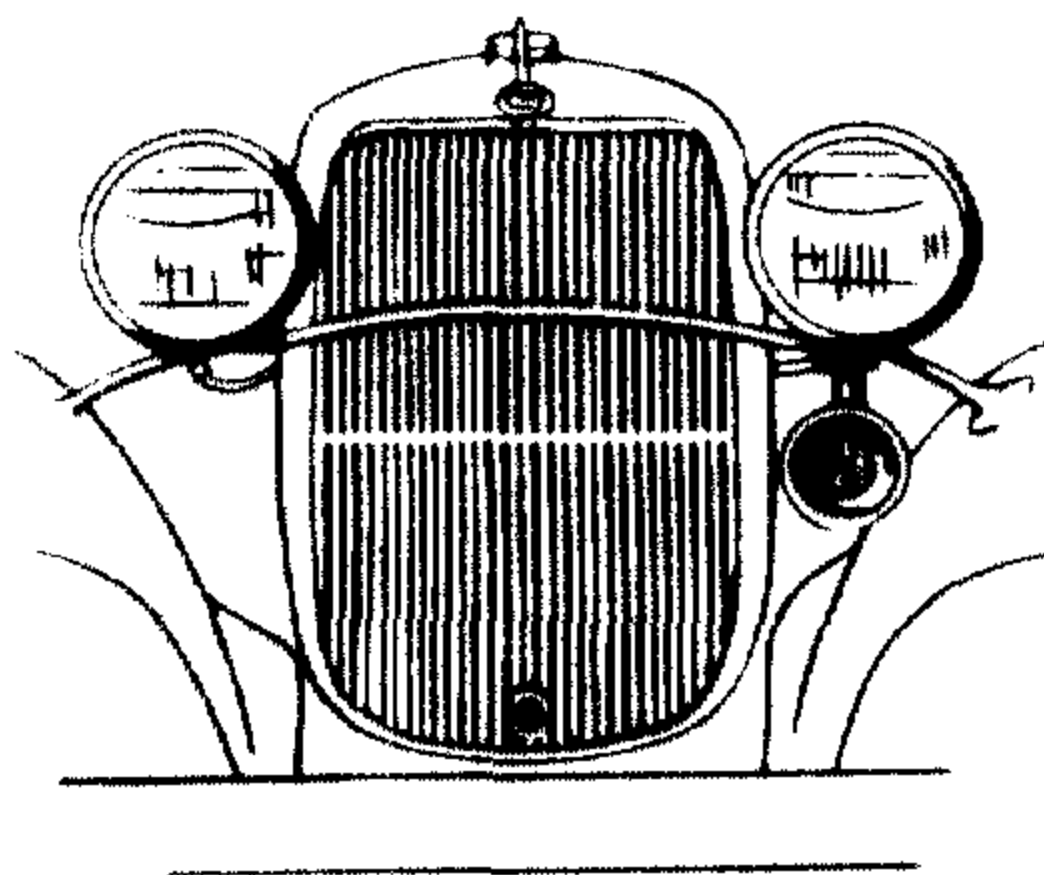

MODEL 46 FORD COMMERCIAL
8 Cylinder Engine (112" Wheelbase)

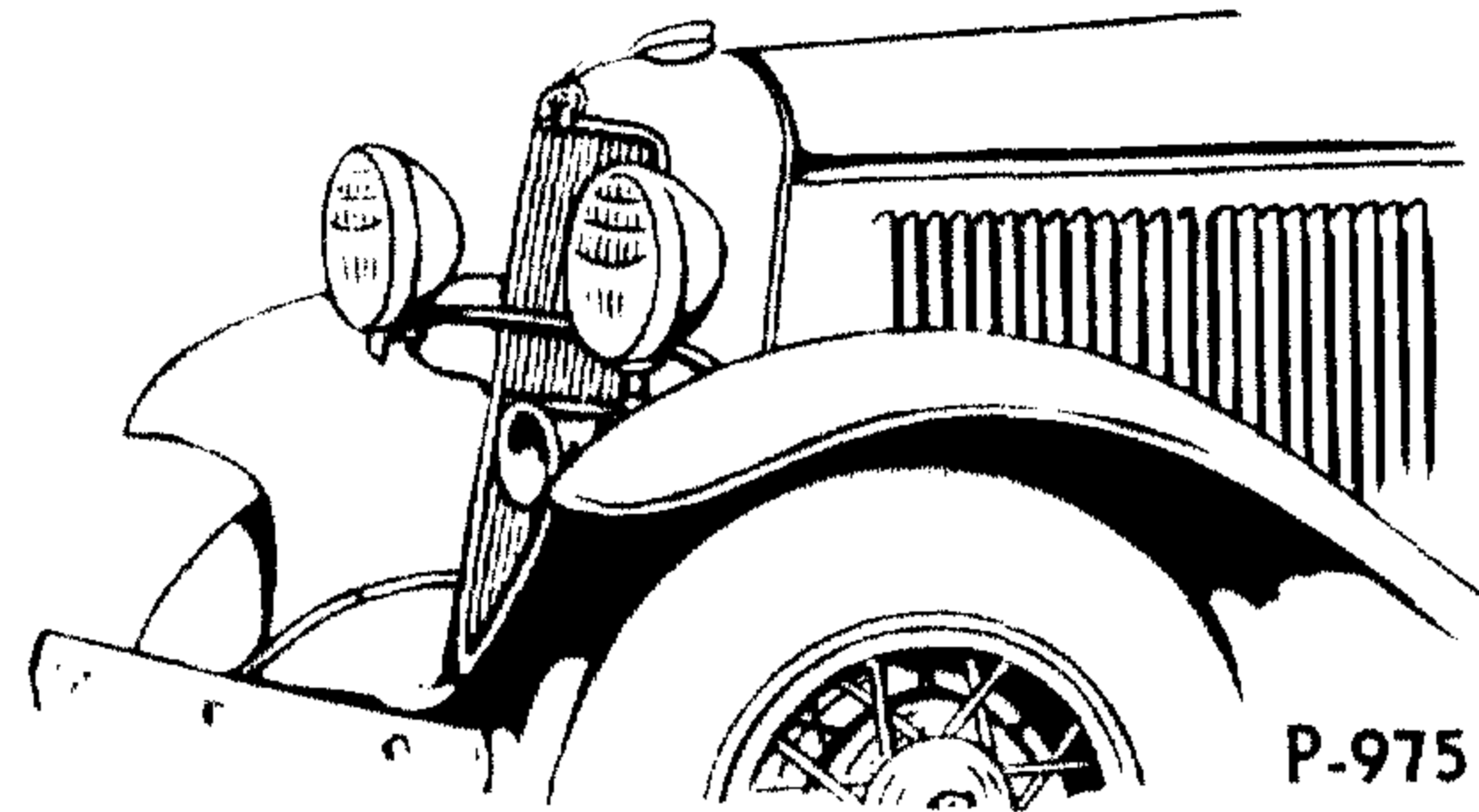

4 Cylinder Engine (112" Wheelbase)

BODY TYPE	NAME	BODY TYPE	NAME
PASSENGER			
700	Tudor Sedan (Standard)	730	Fordor Sedan (De Luxe)
700	Tudor Sedan (De Luxe)	740	Victoria
710	Roadster (Standard)	750	Phaeton (Standard)
710	Roadster (De Luxe)	750	Phaeton (De Luxe)
720	Coupe (Standard) (3 Window)	760	Cabriolet
720	Coupe (De Luxe) (3 Window)	770	Coupe (Standard) (5 Window)
730	Fordor Sedan (Standard)	770	Coupe (De Luxe) (5 Window)
COMMERCIAL AND TRUCK			
85	Panel Delivery (Standard) (131½" Wheelbase)	810	Closed Cab (Specify BB or 46 Chassis)
85	Panel Delivery (De Luxe) (131½" Wheelbase)	820	Panel Delivery (Standard) (112" Wheelbase)
204-A	Dump body assembly—complete with hydraulic hoist—without running board (1½ cu. yd. capacity) (Wood)	820	Panel Delivery (De Luxe) (112" Wheelbase)
210	Panel Delivery (157" Wheelbase)	830	Pickup
800	Open Cab (Specify BB or 46 Chassis)	850	Sedan Delivery
		860	Station Wagon

1934

FORD PASSENGER, COMMERCIAL AND TRUCK MODELS

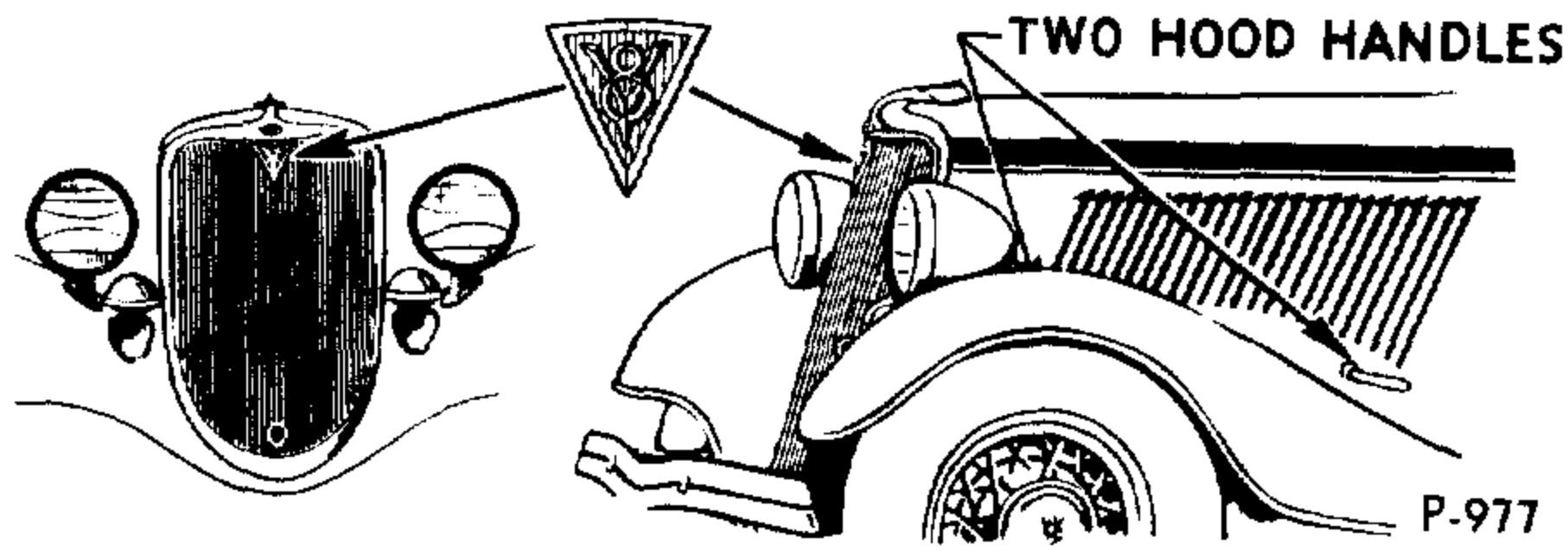

MODEL 40 FORD PASSENGER CAR
 8 Cylinder Engine (112" Wheelbase)
 4 Cylinder Engine (112" Wheelbase)

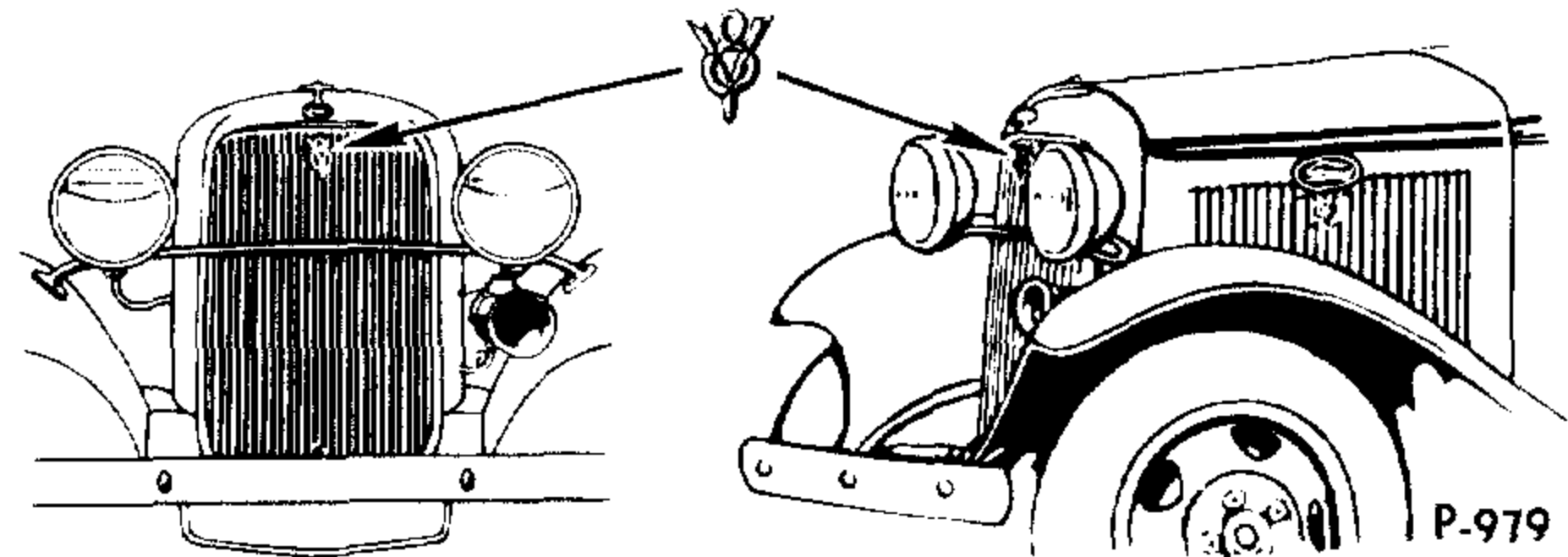

MODEL BB FORD TRUCK
 8 Cylinder Engine (131½" and 157" Wheelbase)
 4 Cylinder Engine (131½" and 157" Wheelbase)

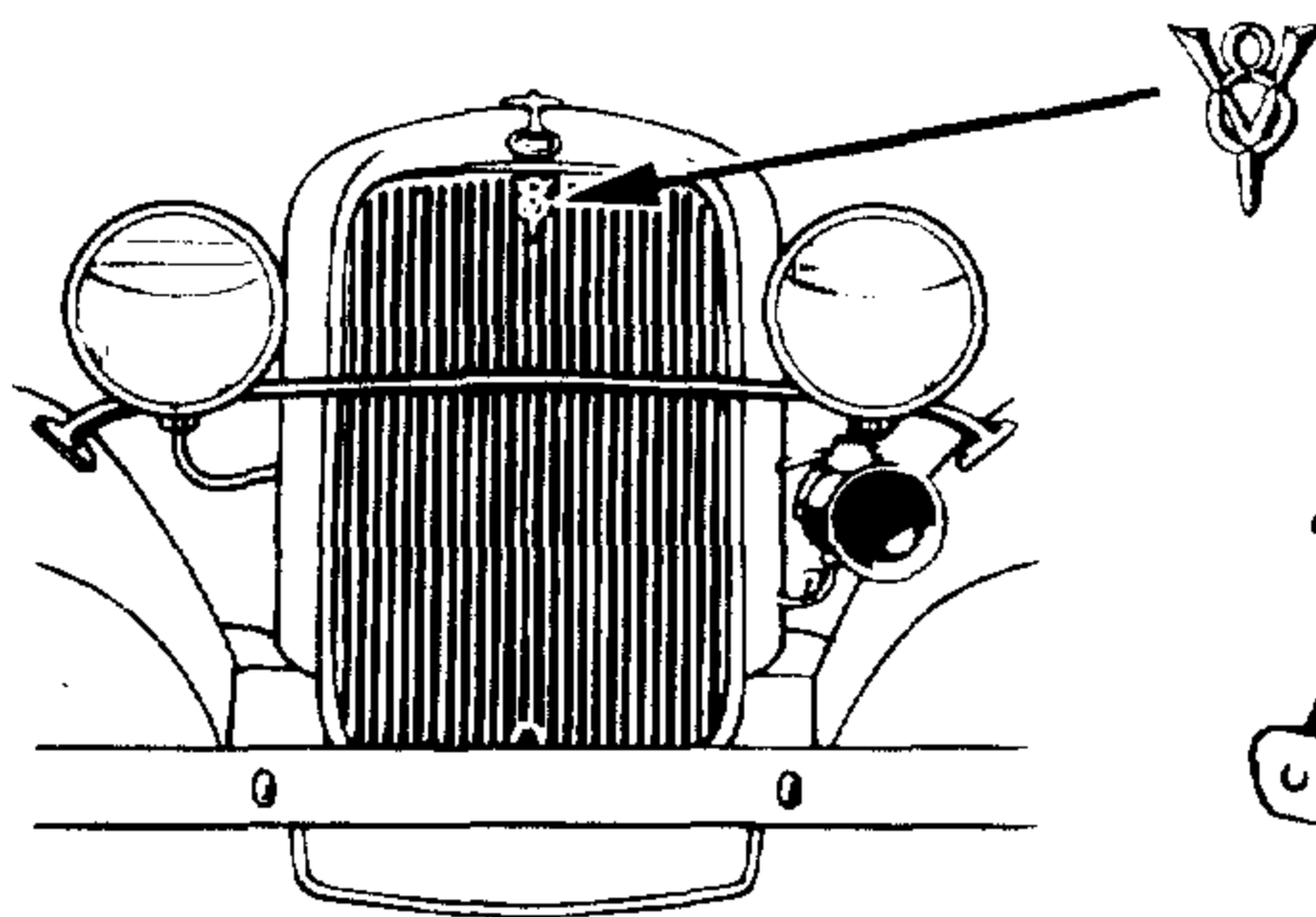

MODEL 46 FORD COMMERCIAL
 8 Cylinder Engine (112" Wheelbase) 4 Cylinder Engine (112" Wheelbase)

BODY TYPE	NAME	BODY TYPE	NAME
PASSENGER			
700	Tudor Sedan (Standard)	730	Fordor Sedan (De Luxe)
700	Tudor Sedan (De Luxe)	740	Victoria
710	Roadster (De Luxe)	750	Phaeton (De Luxe)
720	Coupe (Standard) (3 Window)	760	Cabriolet
720	Coupe (De Luxe) (3 Window)	770	Coupe (Standard) (5 Window)
730	Fordor Sedan (Standard)	770	Coupe (De Luxe) (5 Window)
COMMERCIAL AND TRUCK			
85	Panel Delivery (Standard) (131½" Wheelbase)	810	Closed Cab (Specify BB or 46 Chassis)
85	Panel Delivery (De Luxe) (131½" Wheelbase)	820	Panel Delivery (Standard) (112" Wheelbase)
204-A	Dump body assembly—complete with hydraulic hoist —without running board (1½ cu. yd. capacity) (Wood)	820	Panel Delivery (De Luxe) (112" Wheelbase)
210	Panel Delivery (157" Wheelbase)	830	Pickup
800	Open Cab (Specify BB or 46 Chassis)	850	Sedan Delivery
		860	Station Wagon

1935

FORD PASSENGER, COMMERCIAL AND TRUCK MODELS

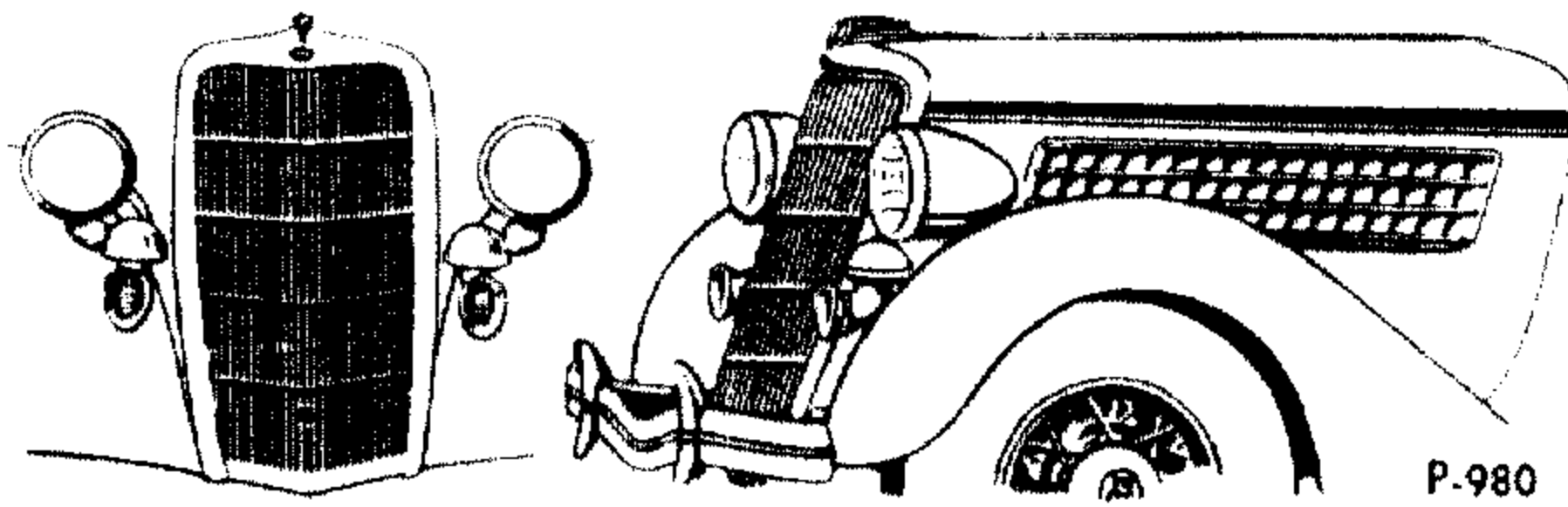

MODEL 48 FORD PASSENGER CAR
8 Cylinder Engine (112" Wheelbase)

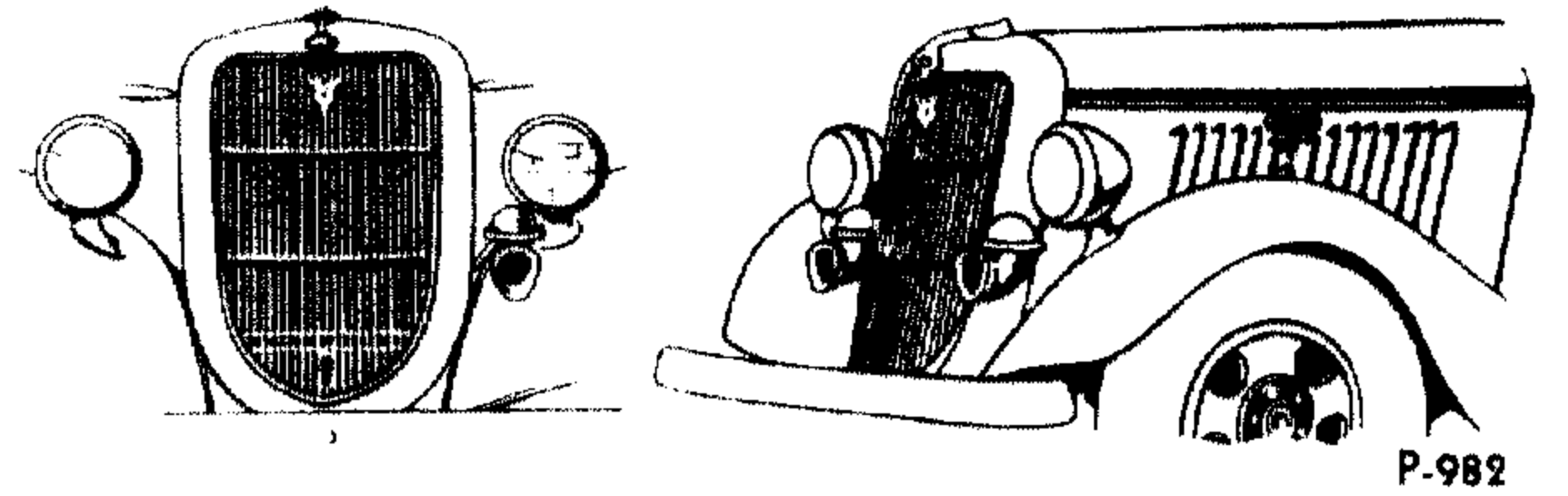

MODEL 51 FORD TRUCK
8 Cylinder Engine (131½" and 157" Wheelbase)

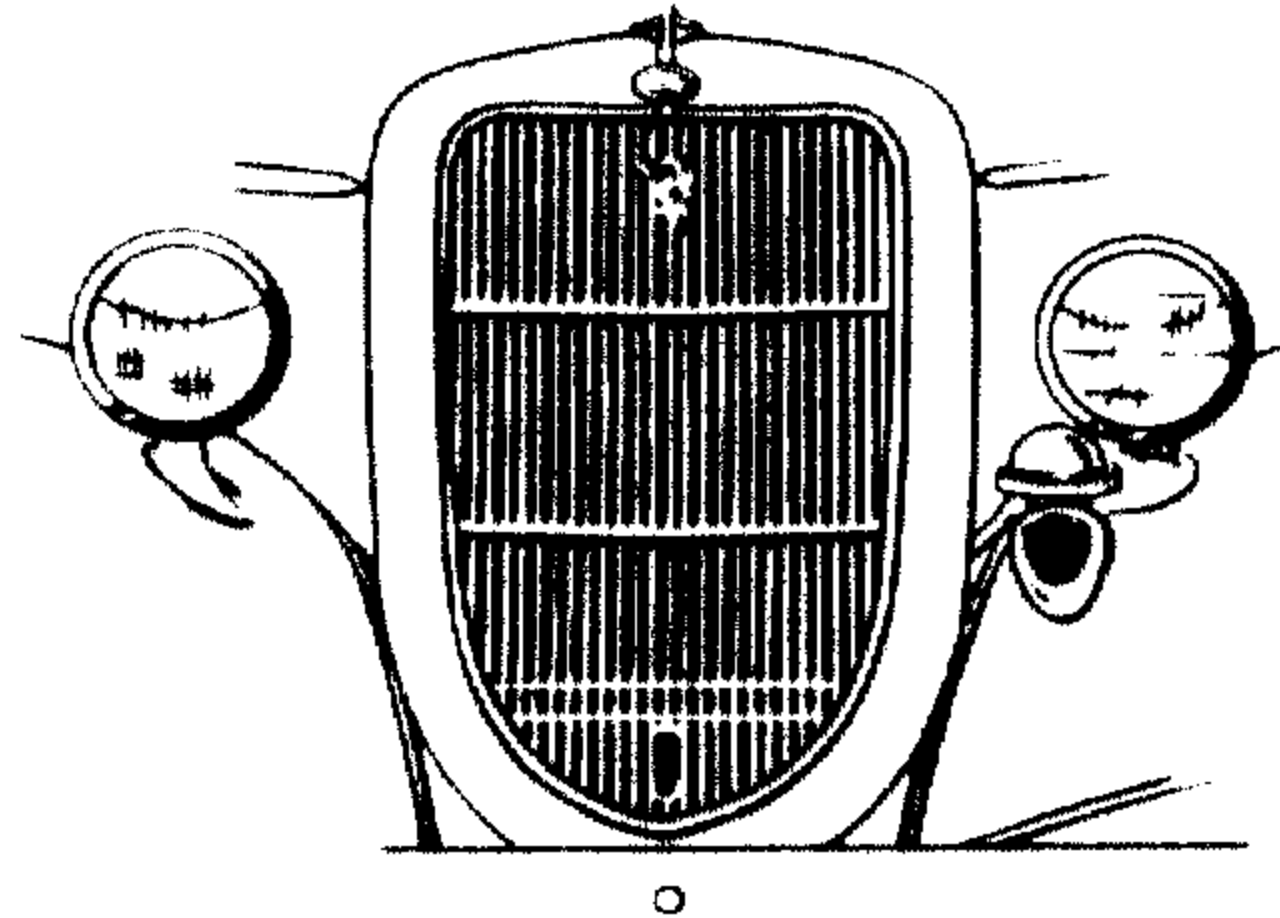

MODEL 50 FORD COMMERCIAL
8 Cylinder Engine (112" Wheelbase)

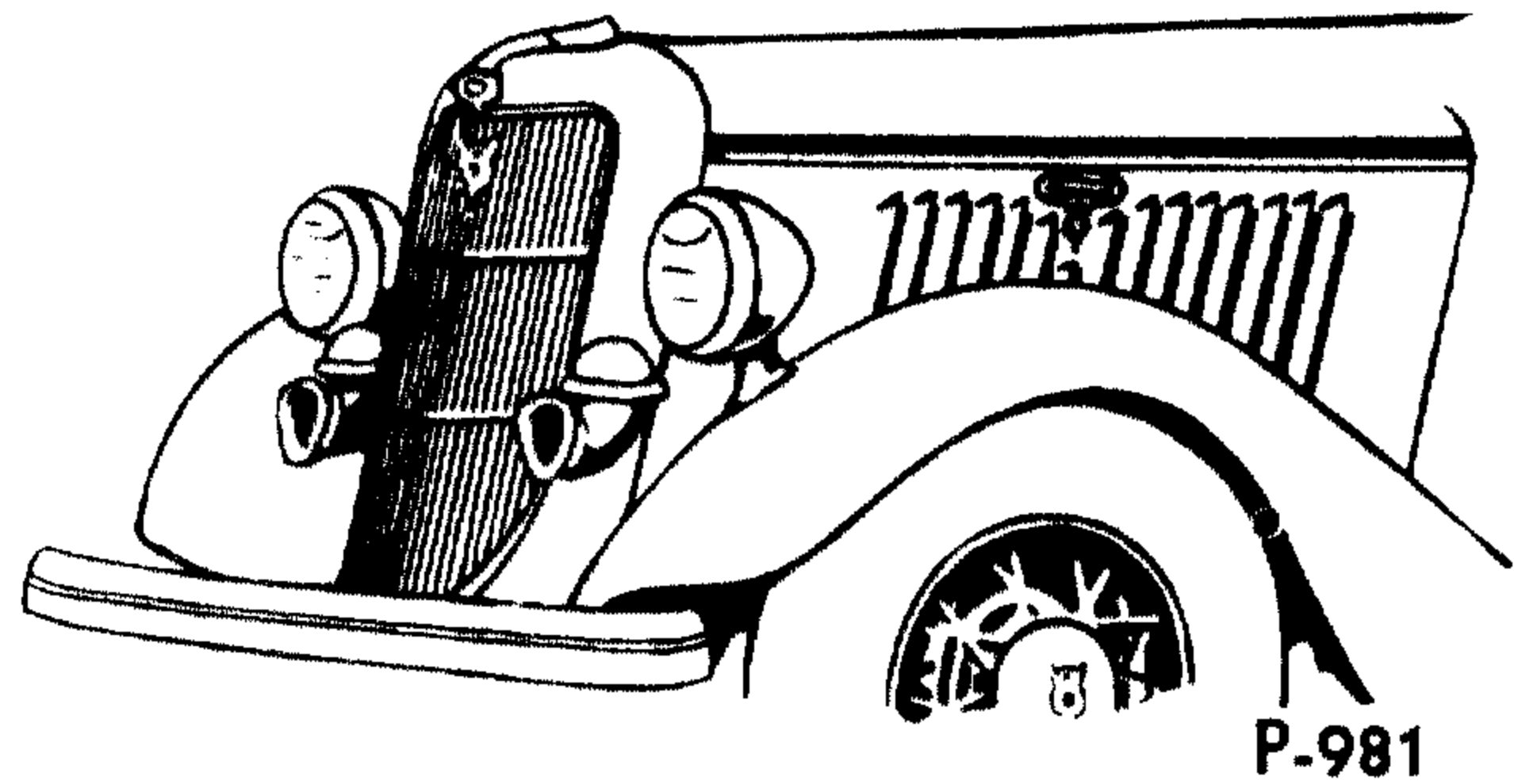

BODY TYPE	NAME	BODY TYPE	NAME
PASSENGER			
700	Tudor Sedan (Standard)	730	Fordor Sedan (Touring)
700	Tudor Sedan (De Luxe)	740	Convertible Sedan
700	Tudor Sedan (Touring)	750	Phaeton
710	Roadster	760	Cabriolet
720	Coupe (3 Window)	770	Coupe (Standard) (5 Window)
730	Fordor Sedan (Standard)	770	Coupe (De Luxe) (5 Window)
730	Fordor Sedan (De Luxe)		
COMMERCIAL AND TRUCK			
204	Dump Body (Wood)	810	Closed Cab
208	Dump Body (Galion)	820	Panel Delivery (112" Wheelbase)
780	Sedan Delivery	830	Pickup
790	Station Wagon	920	Panel Delivery (131½" Wheelbase)

1936

FORD PASSENGER, COMMERCIAL AND TRUCK MODELS

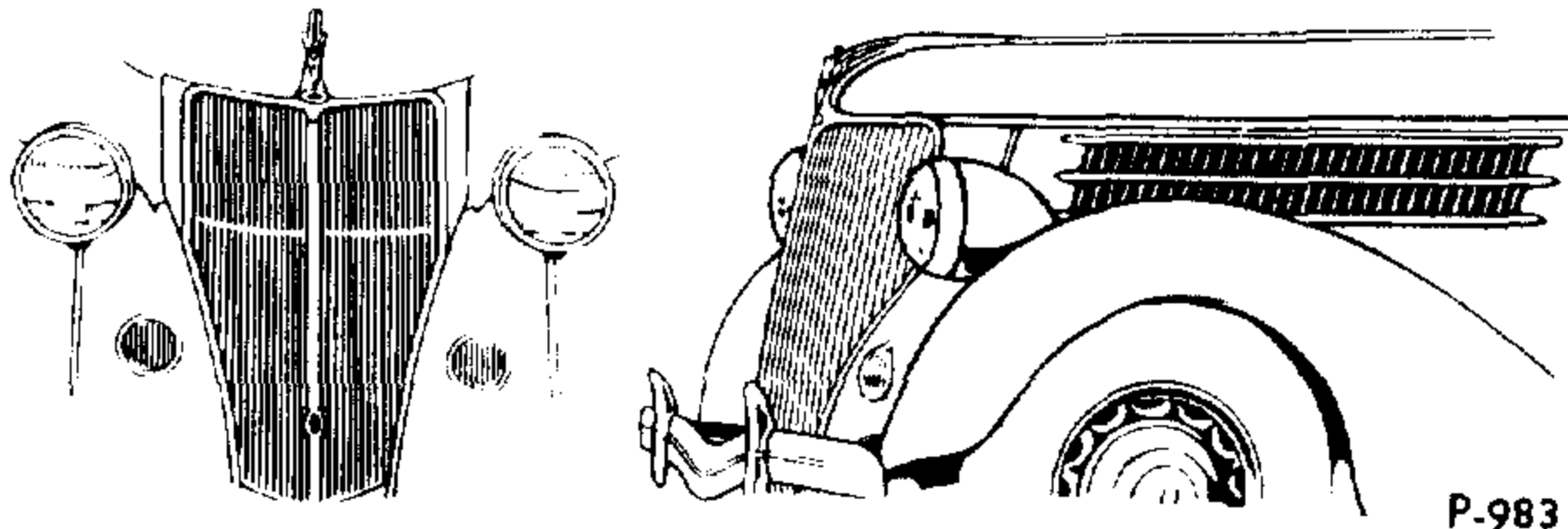

MODEL 68 FORD PASSENGER CAR
8 Cylinder Engine (112" Wheelbase)

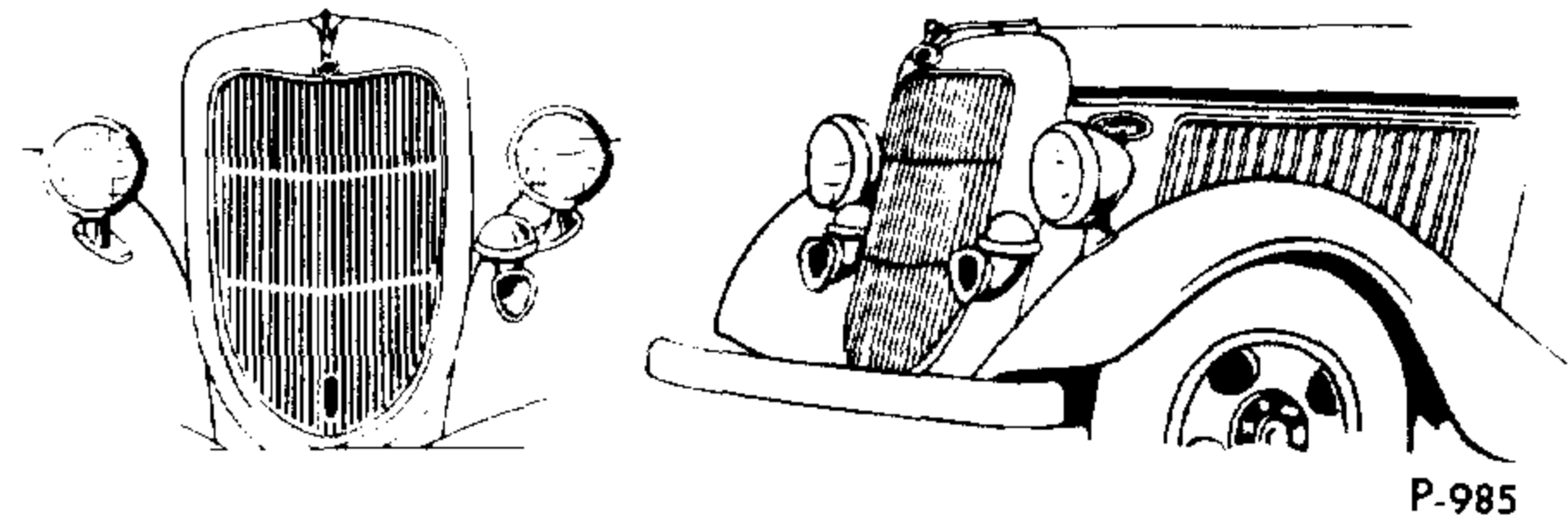

MODEL 51 FORD TRUCK
8 Cylinder Engine (131½" and 157" Wheelbase)

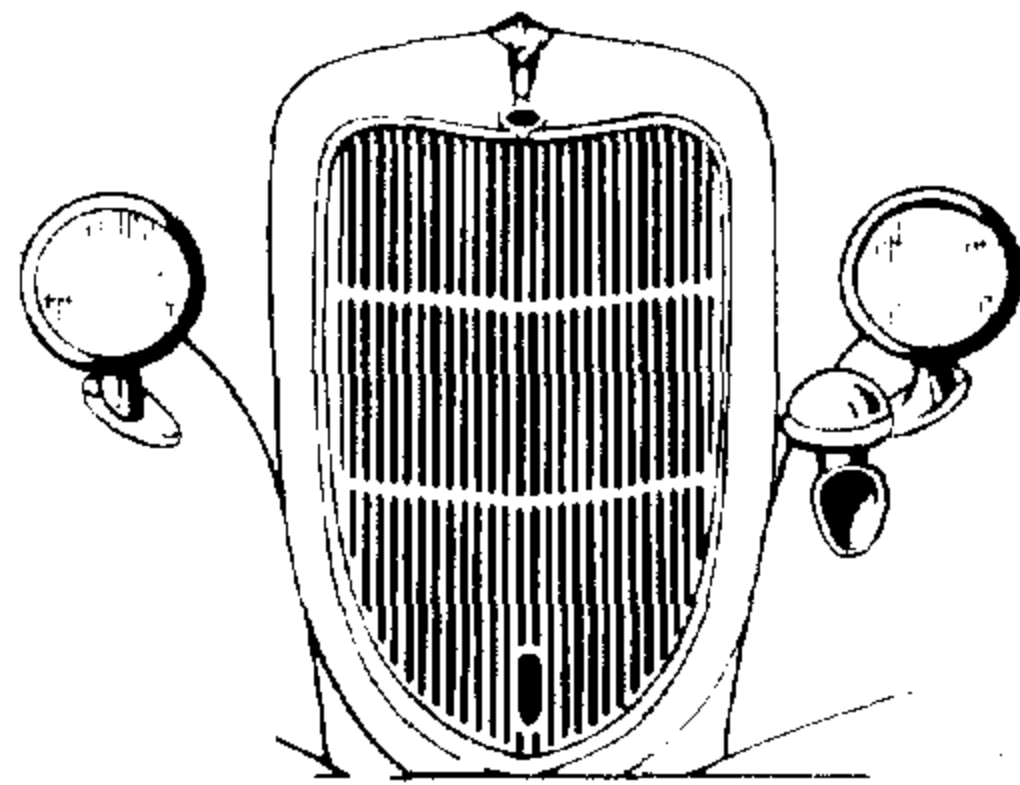

MODEL 67 FORD COMMERCIAL
8 Cylinder Engine (112" Wheelbase)

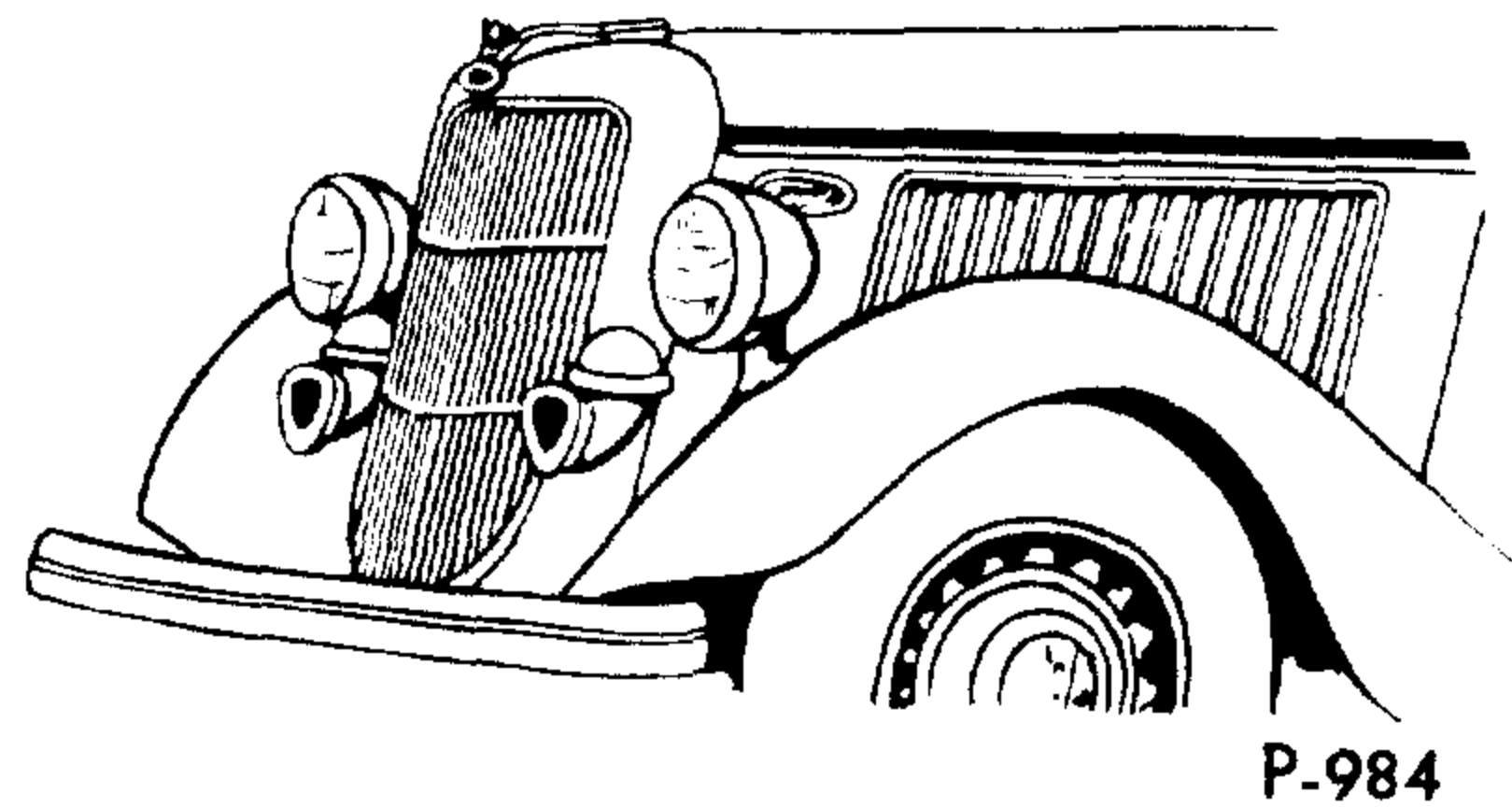

BODY TYPE	NAME	BODY TYPE	NAME
PASSENGER			
700	Tudor Sedan (Standard)	730	Fordor Sedan Touring (Standard)
700	Tudor Sedan (De Luxe)	730	Fordor Sedan Touring (De Luxe)
700	Tudor Sedan Touring (Standard)	740	Convertible Sedan
700	Tudor Sedan Touring (De Luxe)	750	Phaeton
710	Roadster	760	Cabriolet
720	Coupe (3 Window)	760	Club Cabriolet
730	Fordor Sedan (Standard)	770	Coupe (Standard) (5 Window)
730	Fordor Sedan (De Luxe)	770	Coupe (De Luxe) (5 Window)
COMMERCIAL AND TRUCK			
204	Dump Body (Wood)	810	Closed Cab
208	Dump Body (Galion)	820	Panel Delivery (112" Wheelbase)
780	Sedan Delivery	830	Pickup
790	Station Wagon	920	Panel Delivery (131½" Wheelbase)

1937

FORD PASSENGER, COMMERCIAL AND TRUCK MODELS

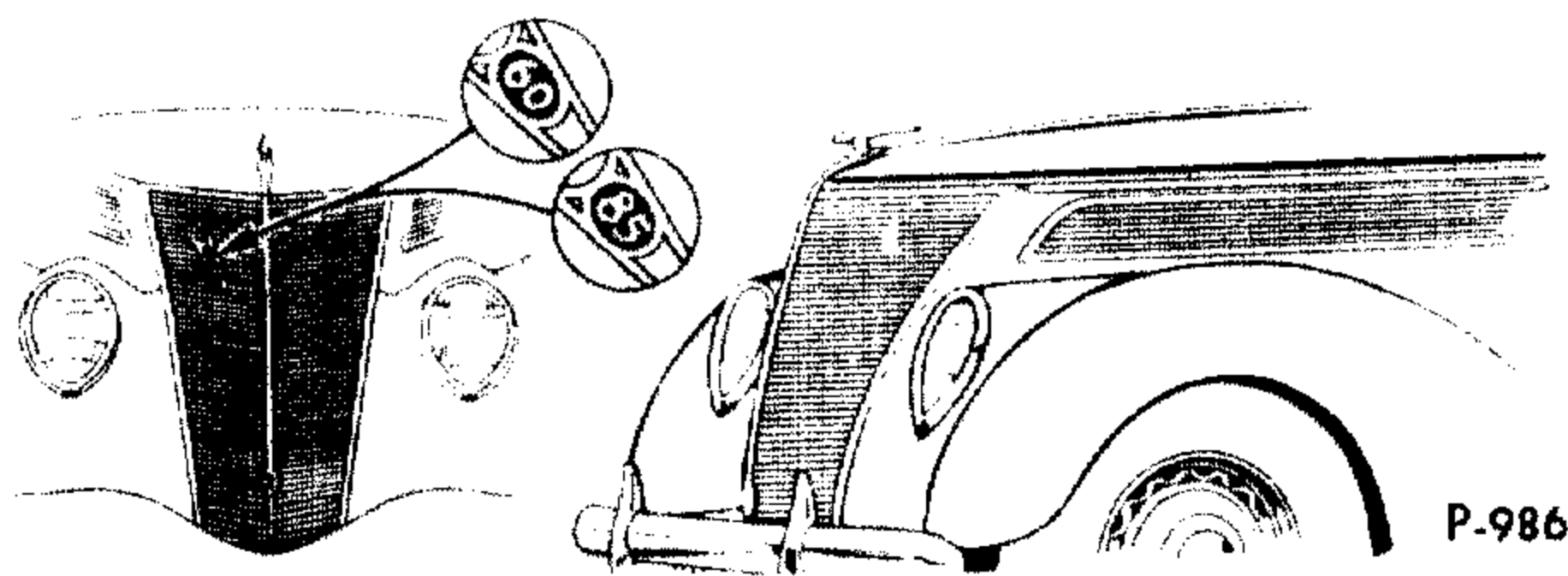

P-986

MODEL 78 FORD PASSENGER CAR
8 Cylinder *85 HP. Engine (112" Wheelbase)

MODEL 74 FORD PASSENGER CAR
8 Cylinder 60 HP. Engine (112" Wheelbase)

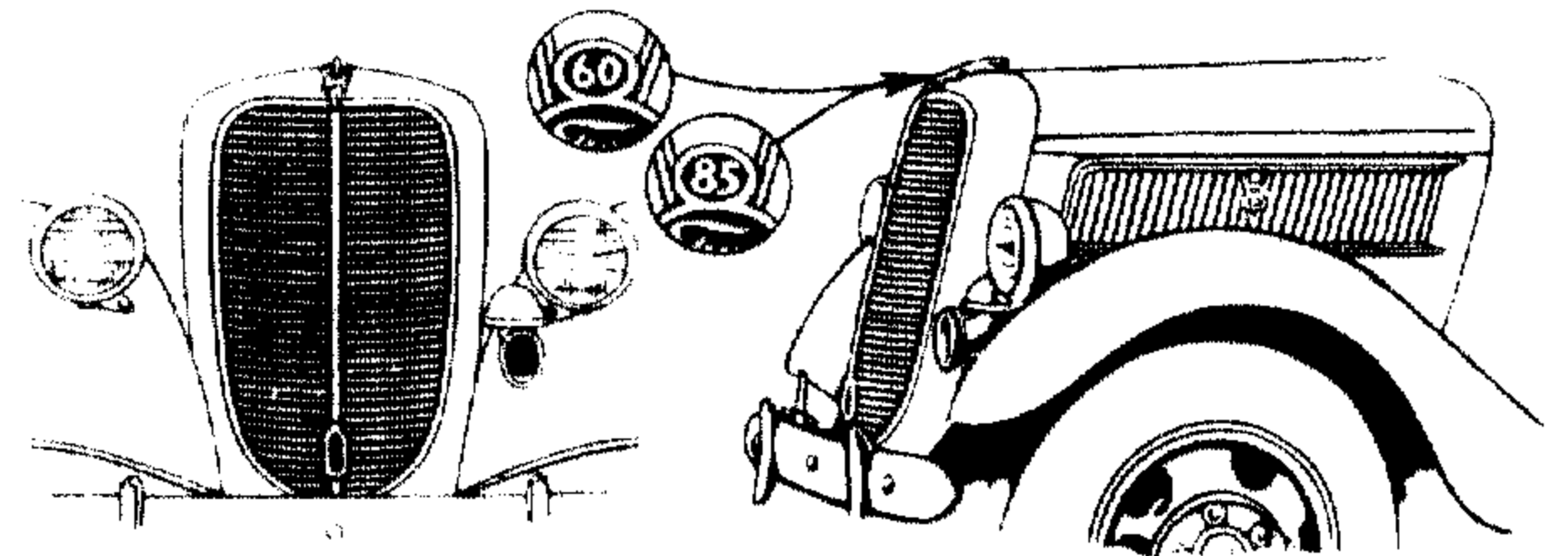

P-988

MODEL 79 FORD TRUCK
8 Cylinder *85 HP. Eng. (131½" and 157" Wheelbase)

MODEL 75 FORD TRUCK
8 Cylinder 60 HP. Engine (131½" Wheelbase)

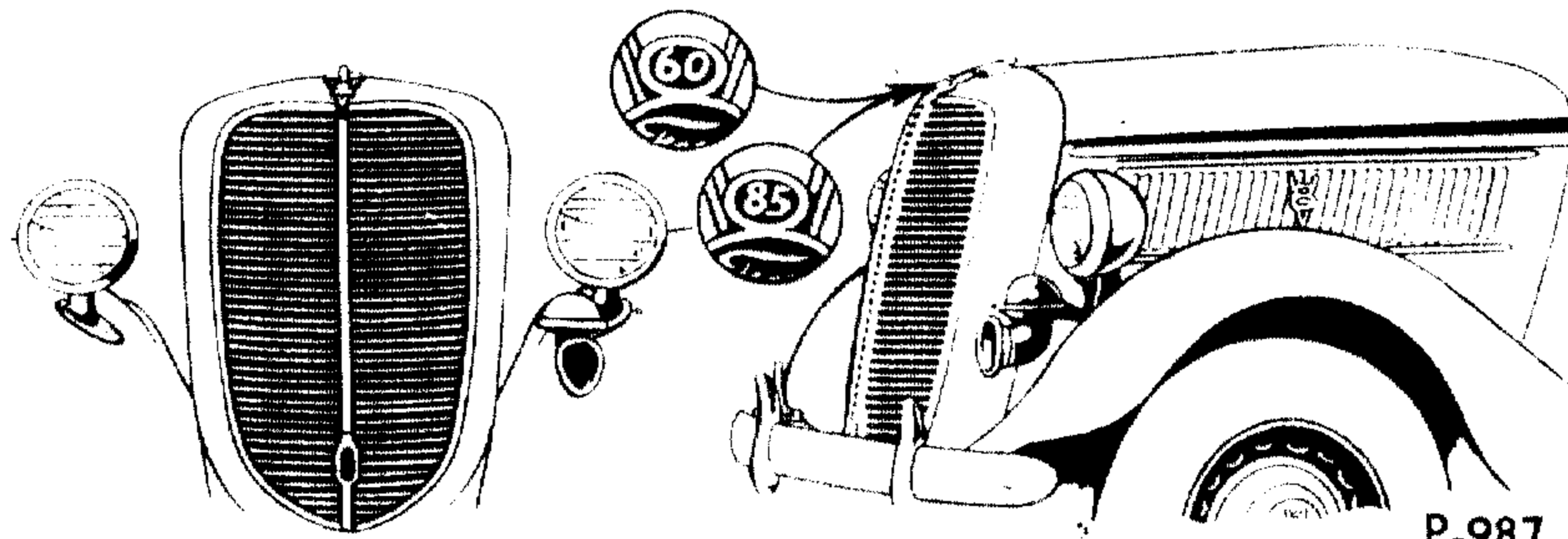

P-987

MODEL 77 FORD COMMERCIAL
8 Cylinder *85 HP. Engine (112" Wheelbase)

MODEL 73 FORD COMMERCIAL
8 Cylinder 60 HP. Engine (112" Wheelbase)

BODY TYPE	NAME	BODY TYPE	NAME
PASSENGER			
700-A	Tudor Sedan (Standard)	730-C	Fordor Sedan (Standard Touring)
700-B	Tudor Sedan (De Luxe)	730-D	Fordor Sedan (De Luxe Touring)
700-C	Tudor Sedan (Standard Touring)	740	Convertible Sedan
700-D	Tudor Sedan (De Luxe Touring)	750	Phaeton (Touring)
710	Roadster	760-A	Cabriolet
720	Coupe (Club)	760-B	Cabriolet (Club)
730-A	Fordor Sedan (Standard)	770-A	Coupe (Standard) (5 Window)
730-B	Fordor Sedan (De Luxe)	770-B	Coupe (De Luxe) (5 Window)
COMMERCIAL AND TRUCK			
204	Dump Body (Wood)	820	Panel Delivery (Standard and De Luxe) (112" Wheelbase)
208	Dump Body (Galion)	830	Pickup
780	Sedan Delivery (Standard)	830	Pickup (Coupe)
780	Sedan Delivery (De Luxe)	900	Platform (131½" Wheelbase)
790	Station Wagon	905	Stake Body complete (131½" Wheelbase)
800	Platform (112" Wheelbase)	920	Panel Delivery (Standard and De Luxe) (131½" Wheelbase)
805	Stake Body complete (112" Wheelbase)	950	Platform (157" Wheelbase)
810	Closed Cab (Standard)	955	Stake Body complete (157" Wheelbase)
810	Closed Cab (De Luxe)		

*Listed throughout catalogue as 90 HP.

1938

FORD PASSENGER CAR MODELS

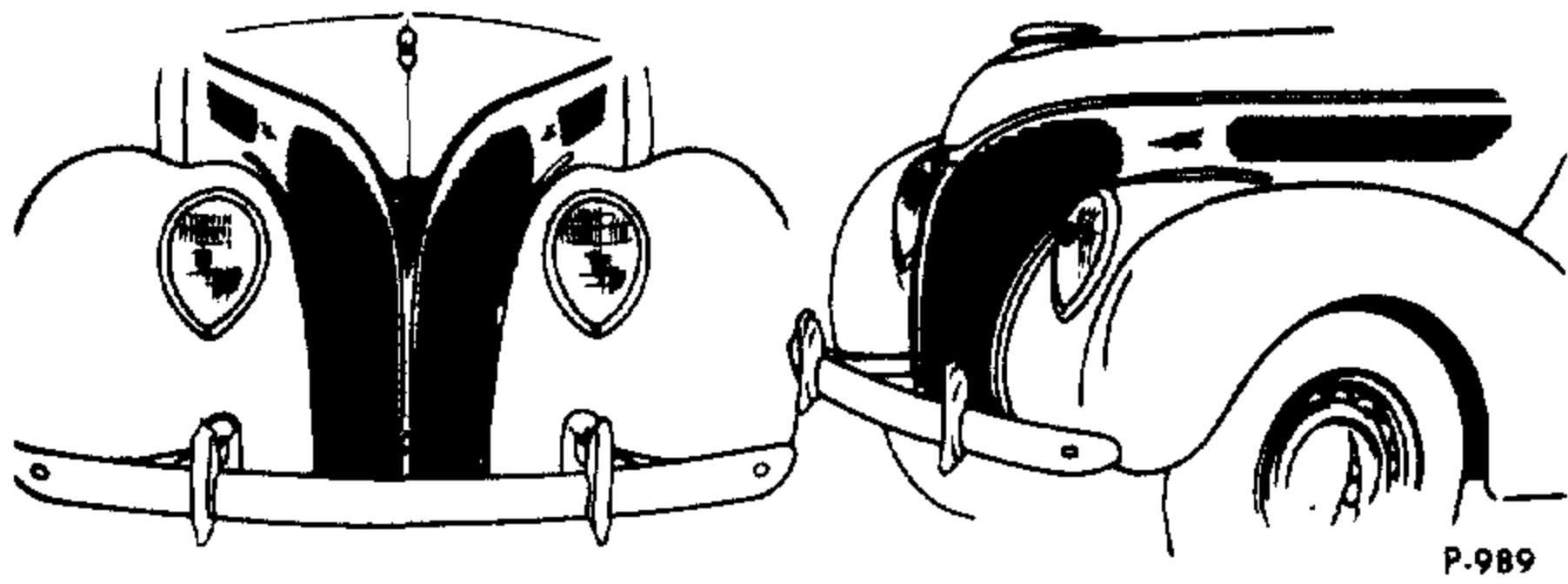

MODEL 81A FORD DELUXE
*85 HP. 8-Cylinder Engine
(112" Wheelbase)

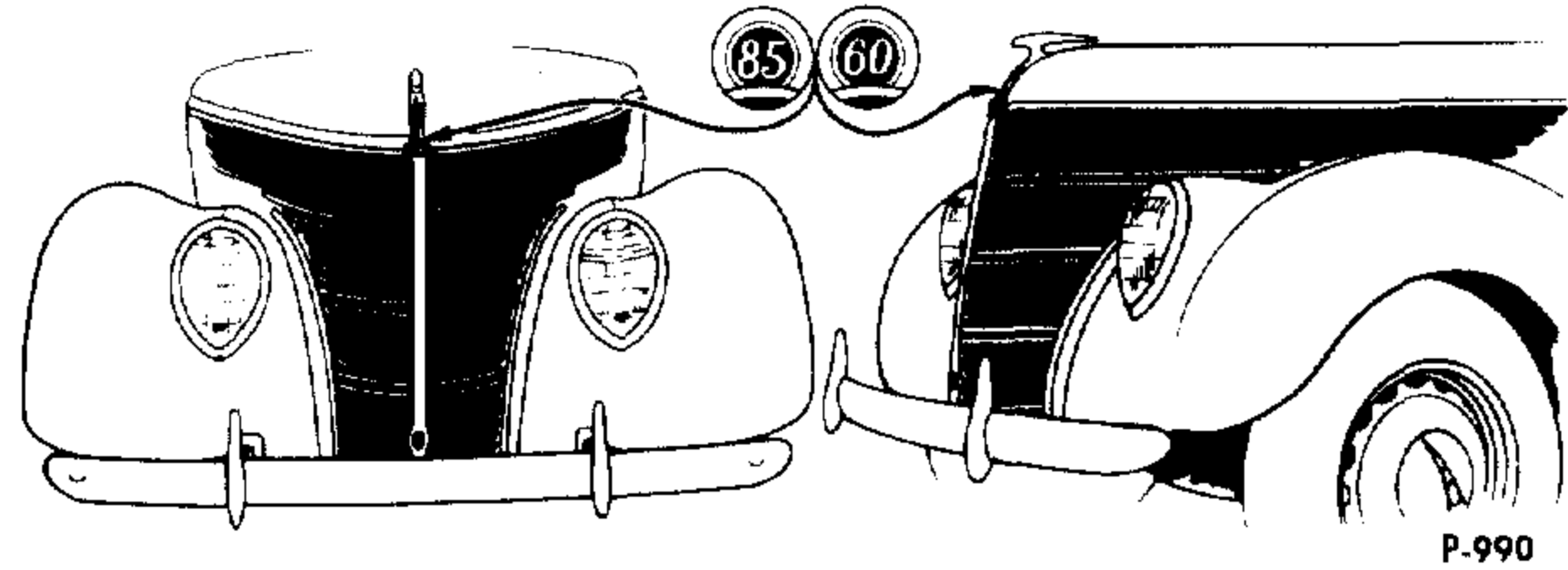

MODEL 81A FORD STANDARD
*85 HP. 8-Cylinder Engine
MODEL 82A FORD 60 HP. 8-Cylinder Engine
(112" Wheelbase)

BODY TYPE	N A M E	BODY TYPE	N A M E
700-B	De Luxe Tudor Sedan	760-B	De Luxe Convertible Club Coupe
700-C	Standard Tudor Sedan	770-A	Standard (5-Window) Coupe
720	De Luxe Club Coupe	770-B	De Luxe (5-Window) Coupe
730-B	De Luxe Fordor Sedan	770-C	Standard (5-Window) Coupe (with pickup)
730-C	Standard Fordor Sedan	780-A	Standard Sedan Delivery
740	De Luxe Convertible Sedan	780-B	De Luxe Sedan Delivery
750	De Luxe Phaeton	790	Station Wagon
760-A	De Luxe Convertible Coupe		

*Listed throughout Catalogue as 90 HP.



1938

FORD COMMERCIAL AND TRUCK MODELS

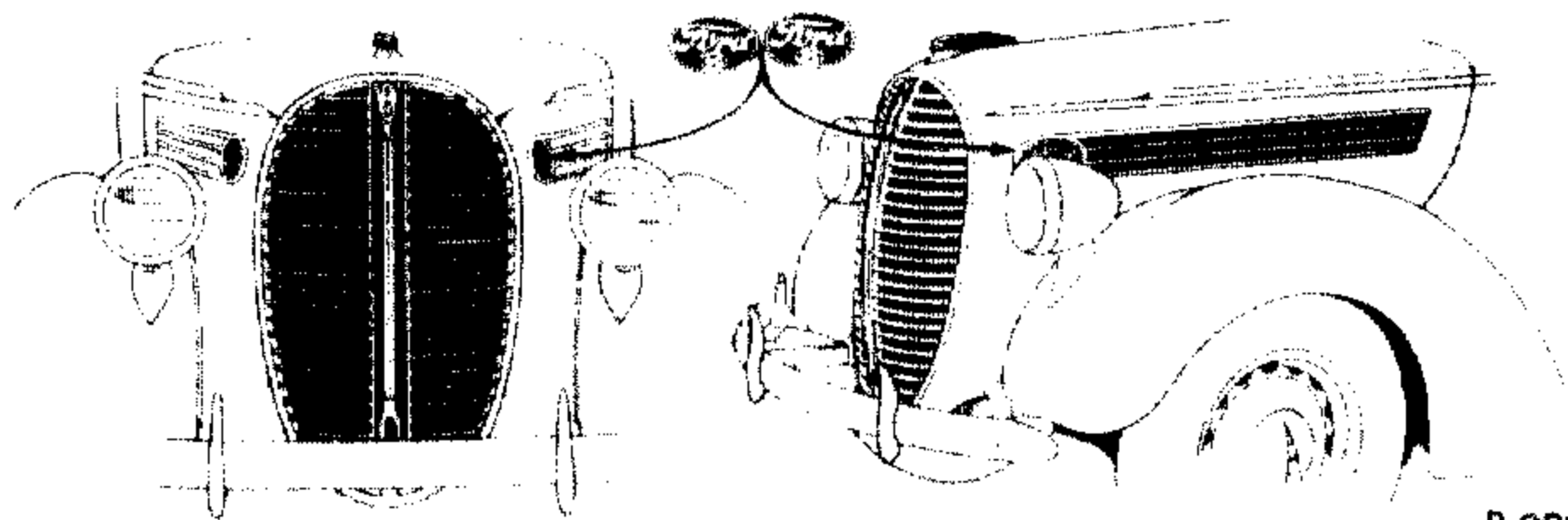

P-991

MODEL 81C FORD COMMERCIAL
*85 HP. 8-Cylinder Engine

MODEL 82C FORD COMMERCIAL
60 HP. 8-Cylinder Engine
(112" Wheelbase)

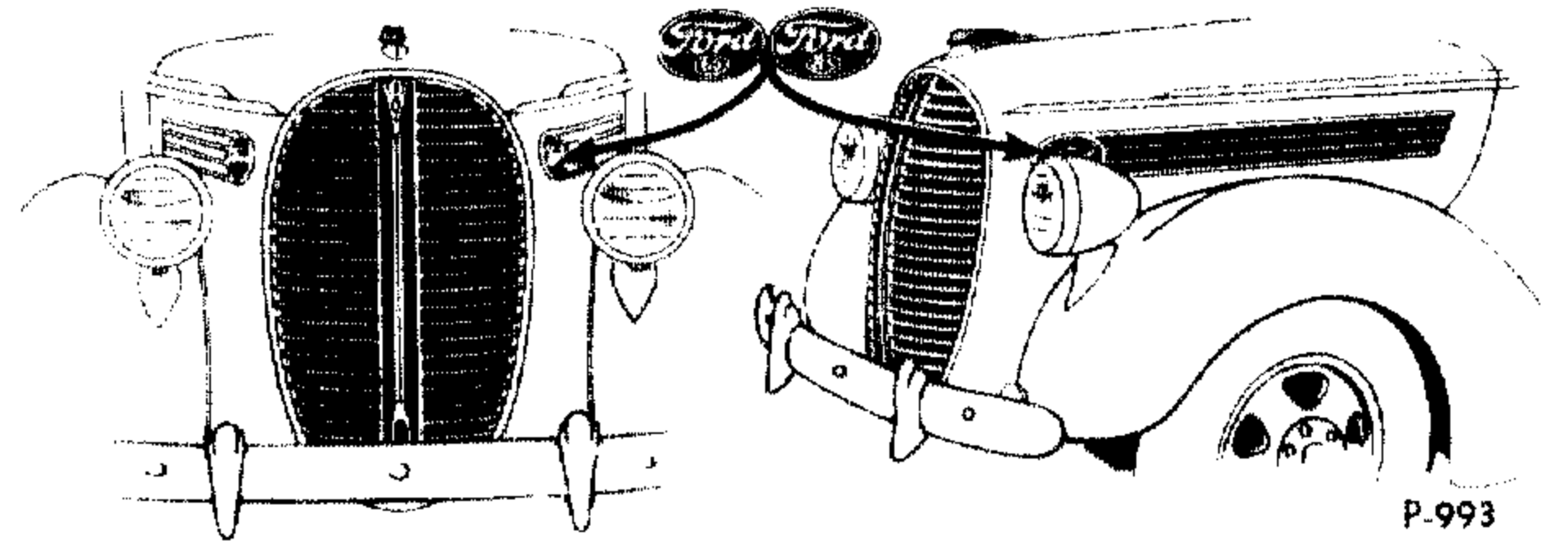

P-993

FORD REGULAR TRUCK
*85 HP. 8-Cylinder Engine

MODEL	WHEELBASE
81T.....	134"
817T.....	157"
§ 81U.....	134"
▷811T.....	191"
◇ School Bus Chassis	
§ Dump Chassis	

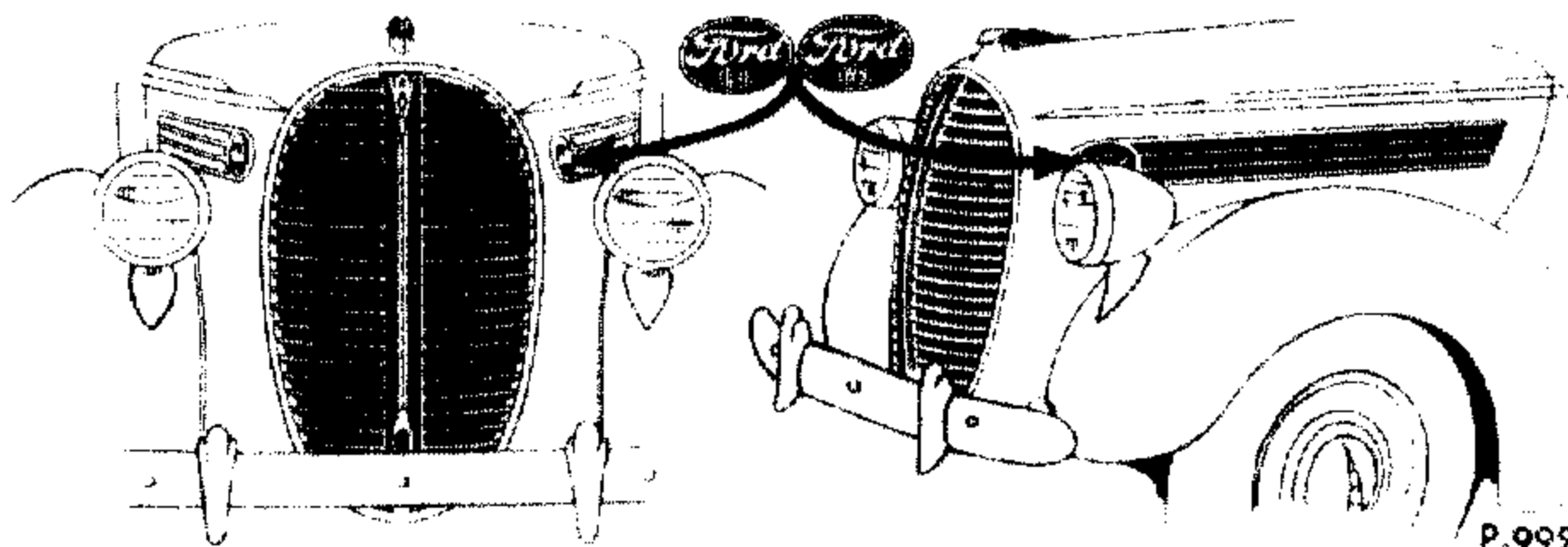

P-992

MODEL 81Y FORD 1 TON TRUCK
*85 HP. 8-Cylinder Engine

MODEL 82Y FORD 1 TON TRUCK
60 HP. 8-Cylinder Engine
(122" Wheelbase)

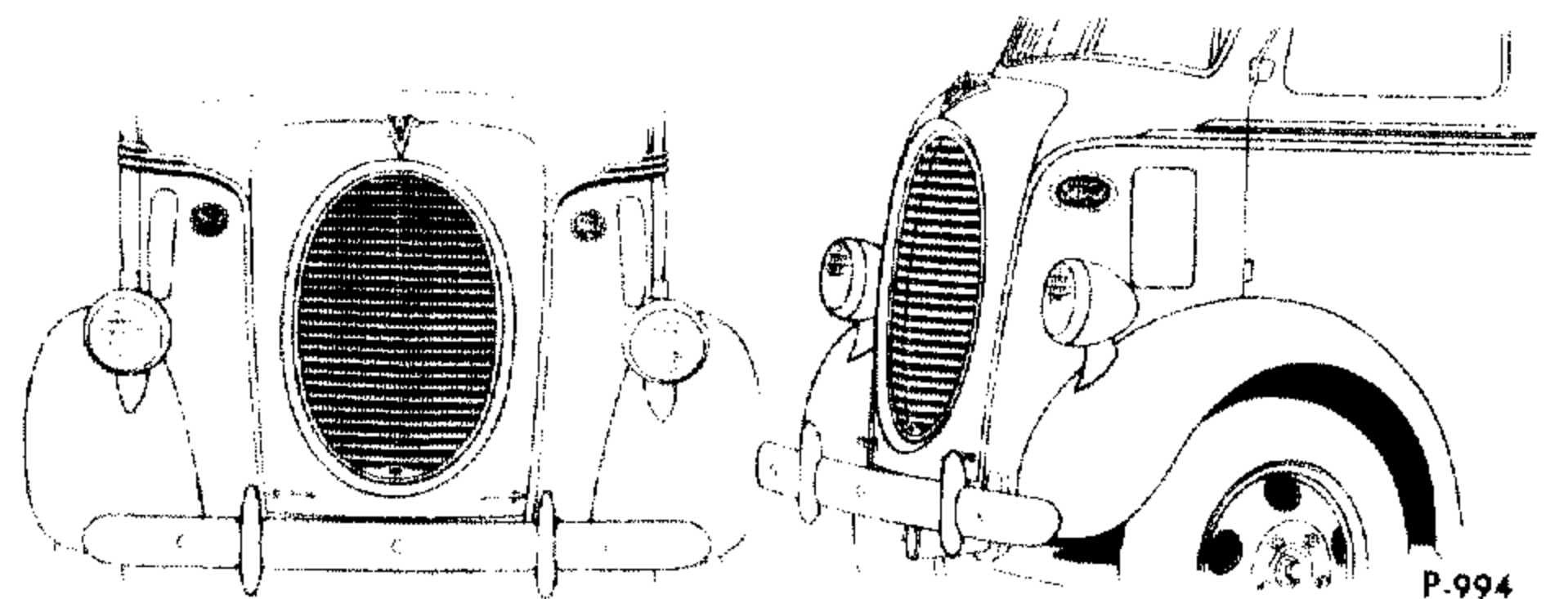

P-994

FORD CAB-OVER-ENGINE TRUCK
*85 HP. 8-Cylinder Engine

MODEL	WHEELBASE
811W.....	101"
81W.....	134"
817W.....	157"
§811Z.....	101"
§ Dump Chassis	

BODY TYPE	NAME	BODY TYPE	NAME
204	Dump Body (Wood) (134" Wheelbase)	830	Pickup (112" Wheelbase)
W-204	Dump Body (Wood) (101" Cab-Over-Engine)	830	Express (122" Wheelbase)
208	Dump Body (Galion) (134" Wheelbase)	900	Platform (122" Wheelbase)
208	Dump Body (Galion) (101" Cab-Over-Engine)	900	Platform (134" Wheelbase)
800	Platform (112" Wheelbase)	900	Platform (101" Cab-Over-Engine)
805	Platform and Rack Assembly (112" Wheelbase)	920	Panel Delivery (122" Wheelbase)
810	Closed Cab (112" Chassis)	920	Panel Delivery (134" Wheelbase)
810	Closed Cab (122", 134" and 157" Chassis)	950	Platform (157" Wheelbase)
810	Closed Cab (Cab-Over-Engine Chassis)	950	Platform (134" Cab-Over-Engine)
820	Panel Delivery (112" Wheelbase)	955	Platform and Rack Assembly (157" Wheelbase)
		955	Platform and Rack Assembly (134" Cab-Over-Engine)

*Listed throughout Catalogue as 90 HP.

1939

FORD PASSENGER CAR MODELS

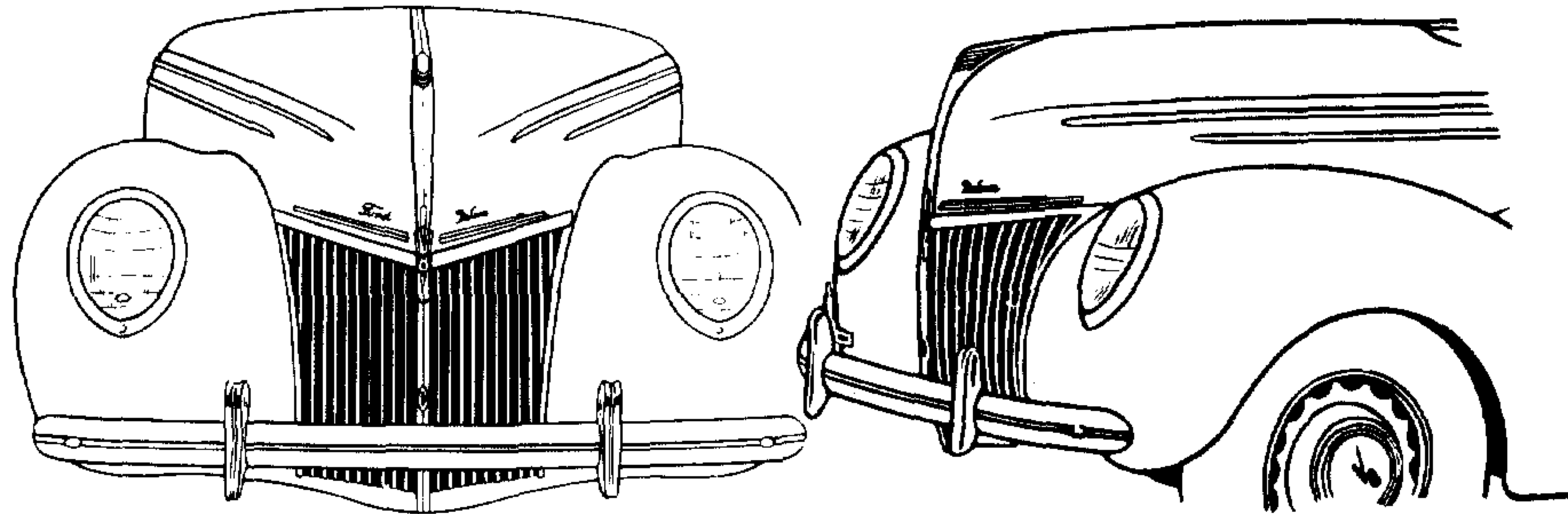

P-995

MODEL 91A FORD DELUXE
***85 HP. 8-Cylinder Engine**
 (112" Wheelbase)

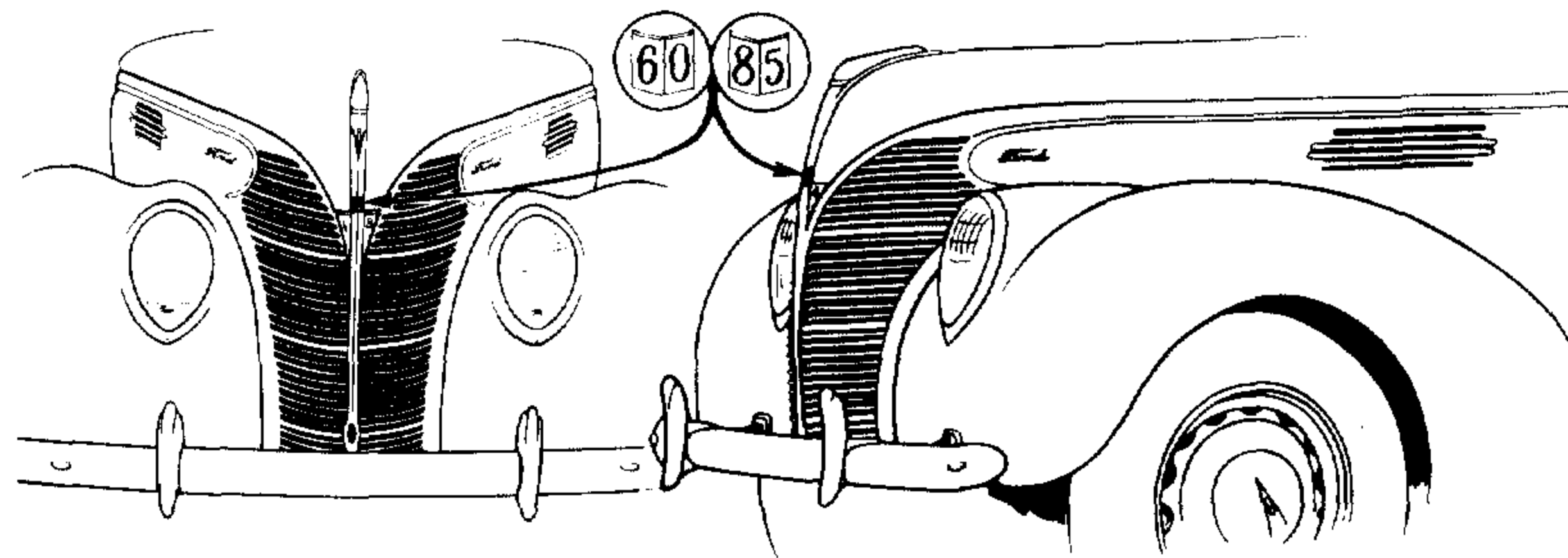

P-996

MODEL 91A FORD STANDARD *85 HP. 8-Cylinder Engine
MODEL 922A FORD 60 HP. 8-Cylinder Engine
 (112" Wheelbase)

BODY TYPE	N A M E	BODY TYPE	N A M E
70-A	Standard Tudor Sedan	76	De Luxe Convertible Coupe
70-B	De Luxe Tudor Sedan	77-A	Standard (5-Window) Coupe
73-A	Standard Fordor Sedan	77-B	De Luxe (5-Window) Coupe
73-B	De Luxe Fordor Sedan	78	Sedan Delivery
74	De Luxe Convertible Fordor Sedan	79	Station Wagon

*Listed throughout Catalogue as 90 HP.

1939

FORD COMMERCIAL AND TRUCK MODELS

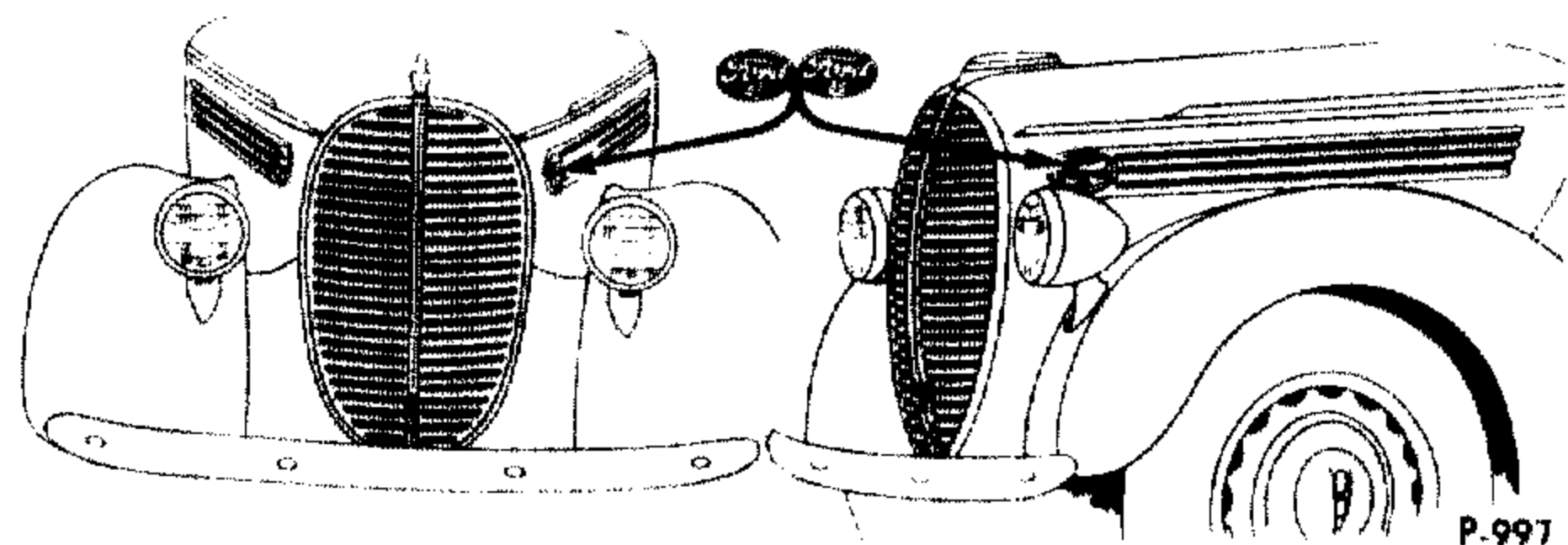

FORD COMMERCIAL

MODEL	WHEELBASE
60 HP. 922C	
*85 HP. 91C	
**95 HP. 99C	112"

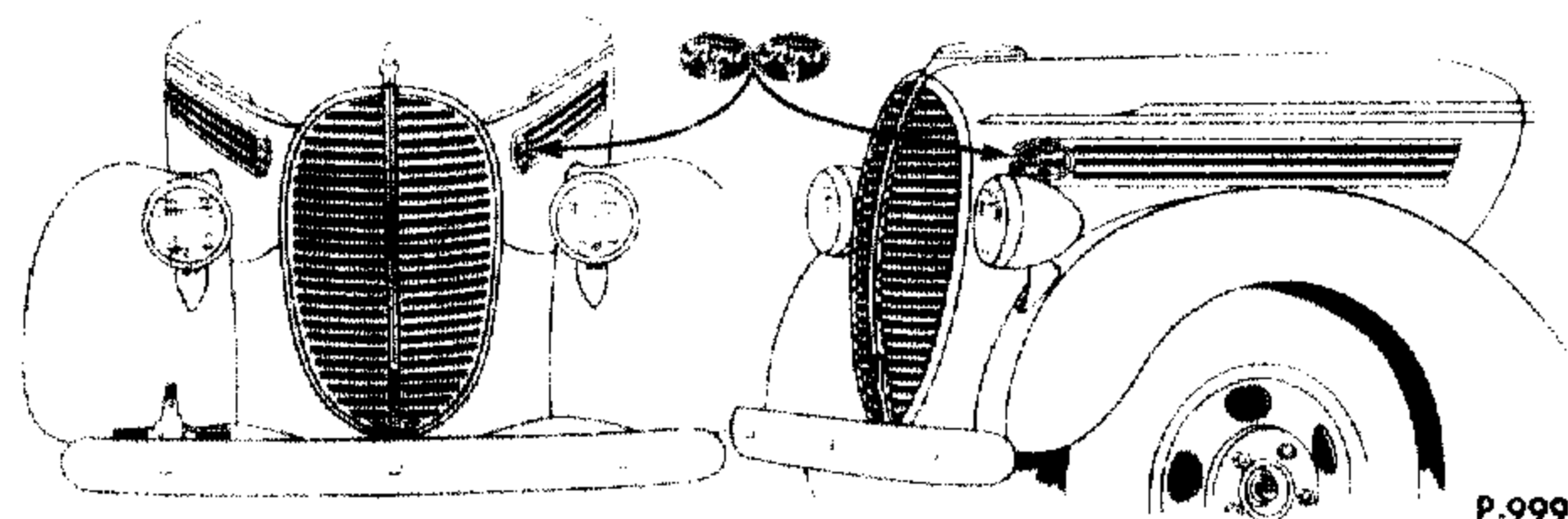

FORD REGULAR TRUCK

MODEL	WHEELBASE
*85 HP. 91T	
**95 HP. 99T	134"
917T	157"
◇911T	191"
§ 91U	134"
◇ School Bus Chassis	§ Dump Chassis

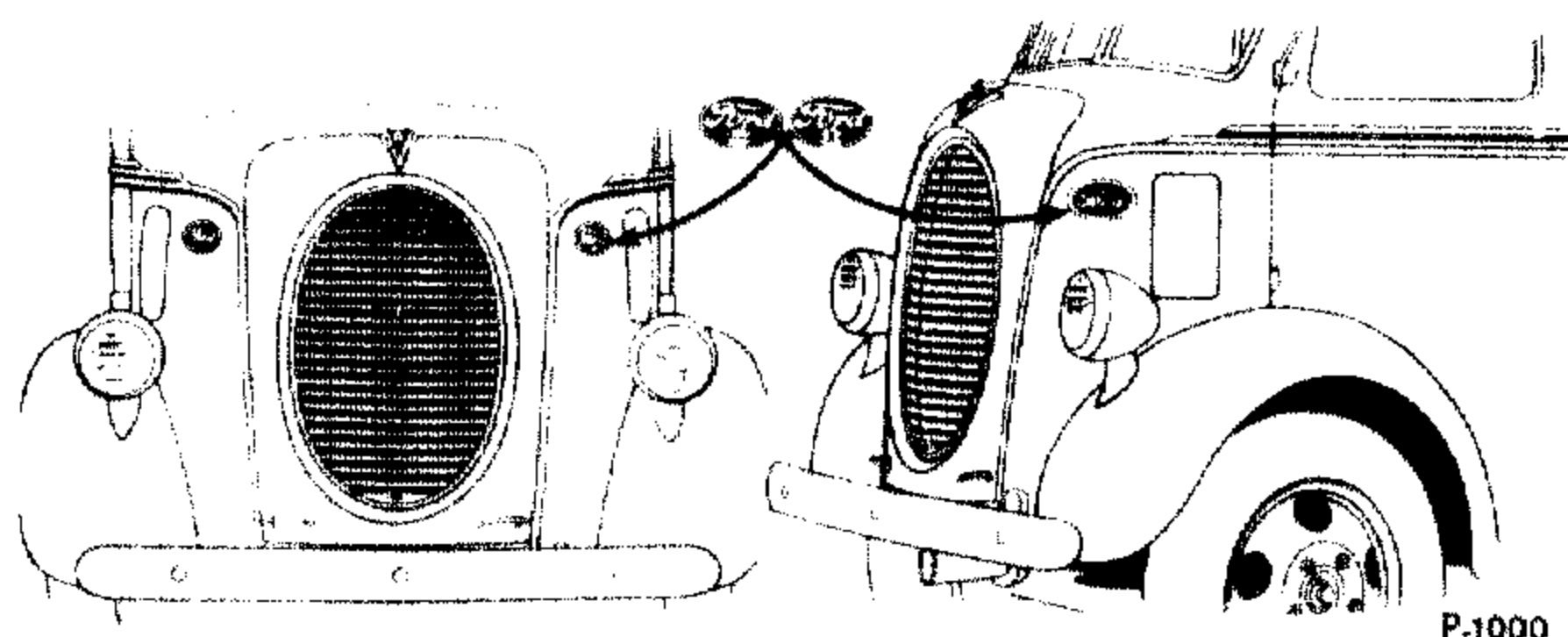

FORD CAB-OVER-ENGINE

MODEL	WHEELBASE
*85 HP. 991W	101"
**95 HP. 991W	134"
91W	157"
917W	101"
§911Z	§991Z
§Dump Chassis	

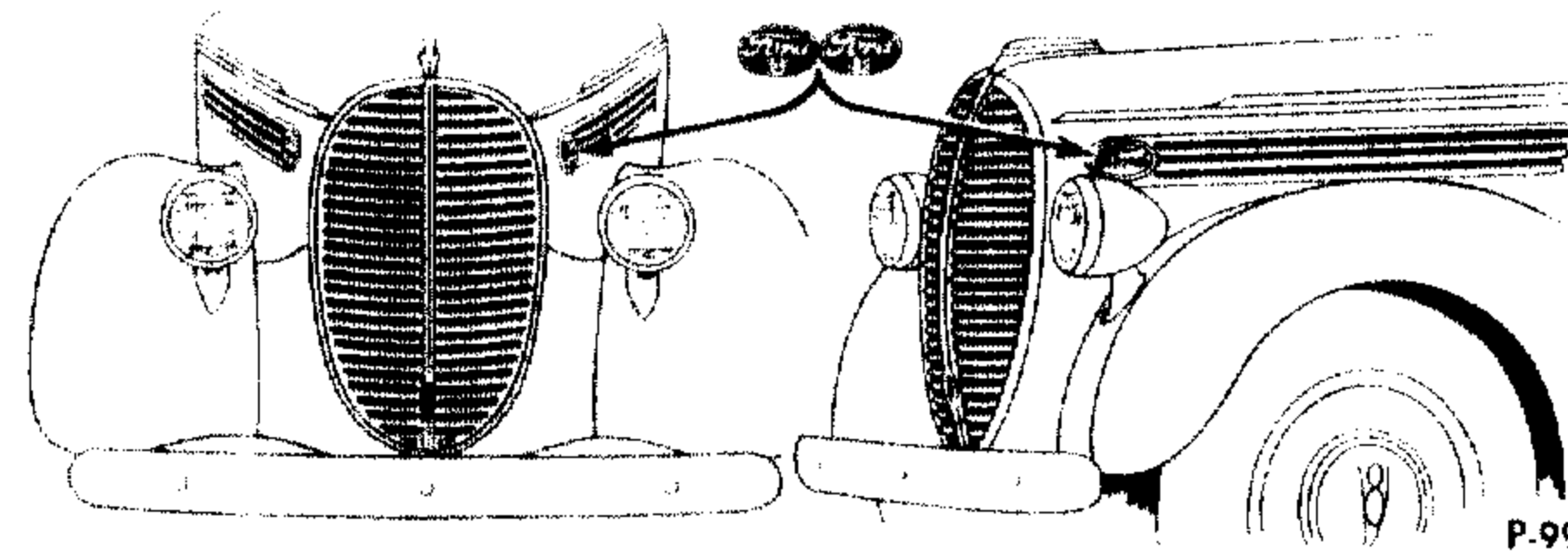

FORD 1 TON TRUCK

MODEL	WHEELBASE
60 HP. 92Y	
*85 HP. 91Y	122"
*95 HP. 99Y	

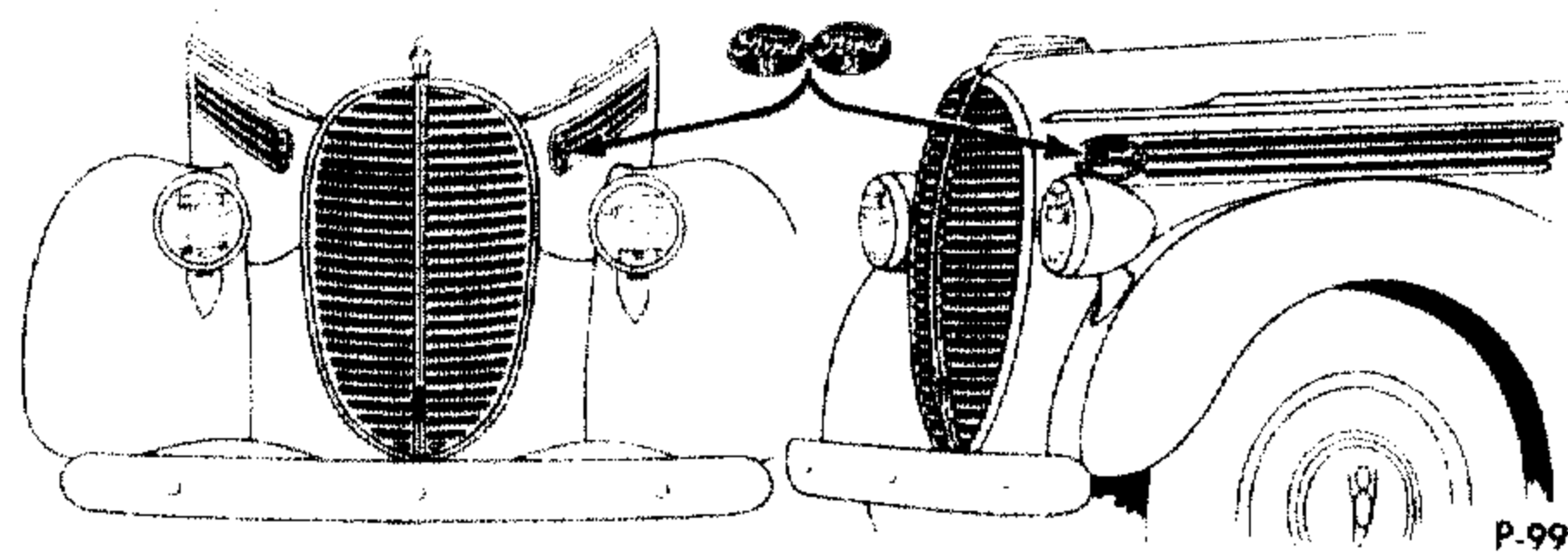

FORD 3/4 TON TRUCK

MODEL	WHEELBASE
60 HP. 92D	
*85 HP. 91D	122"
**95 HP. 99D	

BODY TYPE	NAME	BODY TYPE	NAME
80	Platform (112" Wheelbase)	82	Panel Delivery (3/4 Ton) (122" Wheelbase)
80	Platform (3/4 Ton) (122" Wheelbase)	82	Panel Delivery (1 Ton) (122" Wheelbase)
80	Platform (1 Ton) (122" Wheelbase)	82	Panel Delivery (134" Wheelbase)
80	Platform (134" Regular and 101" Cab-Over-Engine)	83	Pickup (112" Wheelbase)
80	Platform (134" Cab-Over-Engine)	83	Express (3/4 Ton) (122" Wheelbase)
80	Platform (157" Wheelbase)	83	Express (1 Ton) (122" Wheelbase)
81	Closed Cab (122" Chassis)	87	Dump Body (Wood) (134" Wheelbase)
81	Closed Cab (122", 134" and 157" Chassis)	88	Dump Body (Galion) (134" Wheelbase)
81	Closed Cab (Cab-Over-Engine Chassis)	87	Dump Body (Wood) (101" Cab-Over-Engine)
82-A	Panel Delivery (with slats) (112" Wheelbase)	88	Dump Body (Galion) (101" Cab-Over-Engine)
82-B	Panel Delivery (with masonite) (112" Wheelbase)		

*Listed throughout Catalogue as 90 HP.
 **Listed throughout Catalogue as 100 HP.

1940

FORD PASSENGER CAR MODELS

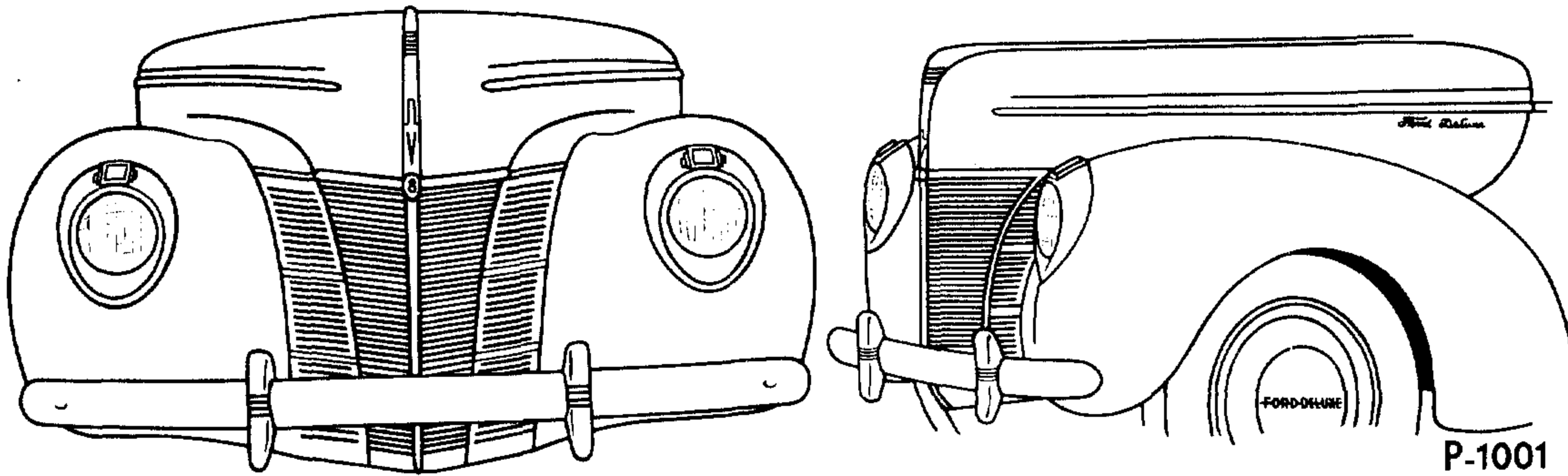

MODEL 01A FORD DELUXE
***85 HP. 8-Cylinder Engine**
 (112" Wheelbase)

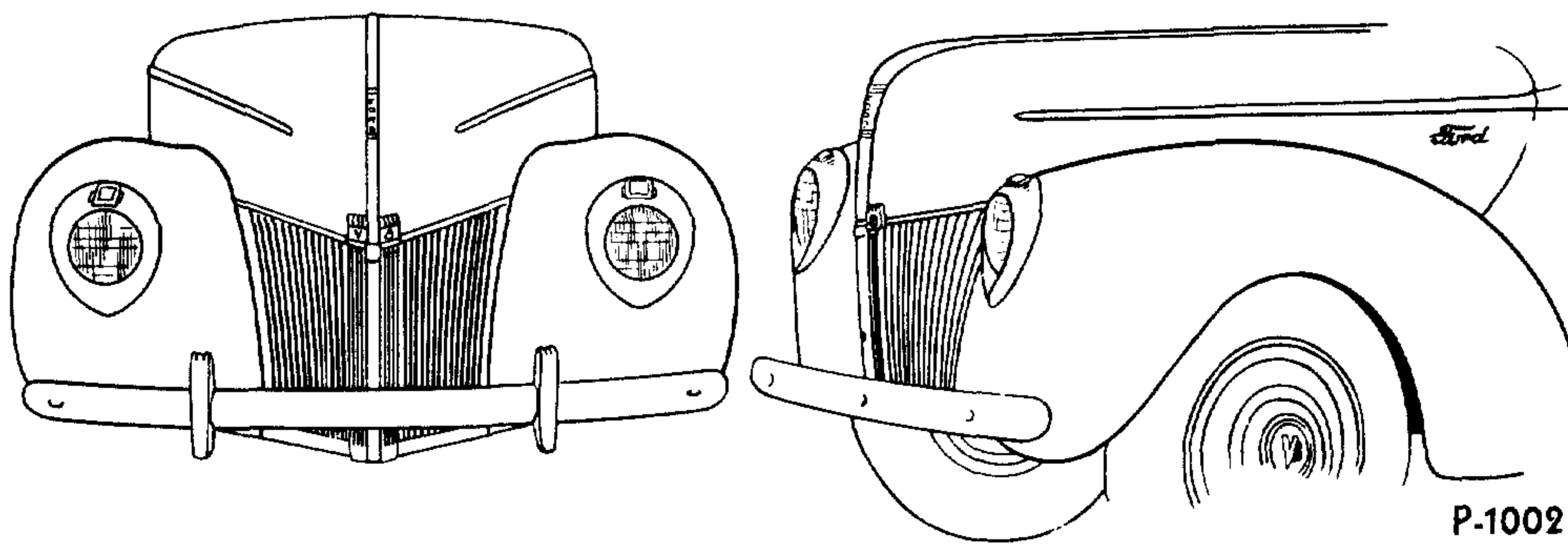

MODEL 01A FORD—STANDARD *85 HP. 8-Cylinder Engine
MODEL 022A FORD—60 HP. 8-Cylinder Engine
 (112" Wheelbase)

BODY TYPE	N A M E	BODY TYPE	N A M E
66	De Luxe Convertible Club Coupe	73-B	De Luxe Fordor Sedan
67-A	Standard Business Coupe	77-A	Standard (5-Window) Coupe
67-B	De Luxe Business Coupe	77-B	De Luxe (5-Window) Coupe
70-A	Standard Tudor Sedan	78	De Luxe Sedan Delivery
70-B	De Luxe Tudor Sedan	79-A	Standard Station Wagon
73-A	Standard Fordor Sedan	79-B	De Luxe Station Wagon

*Listed throughout Catalogue as 90 HP.

1940

FORD COMMERCIAL AND TRUCK MODELS

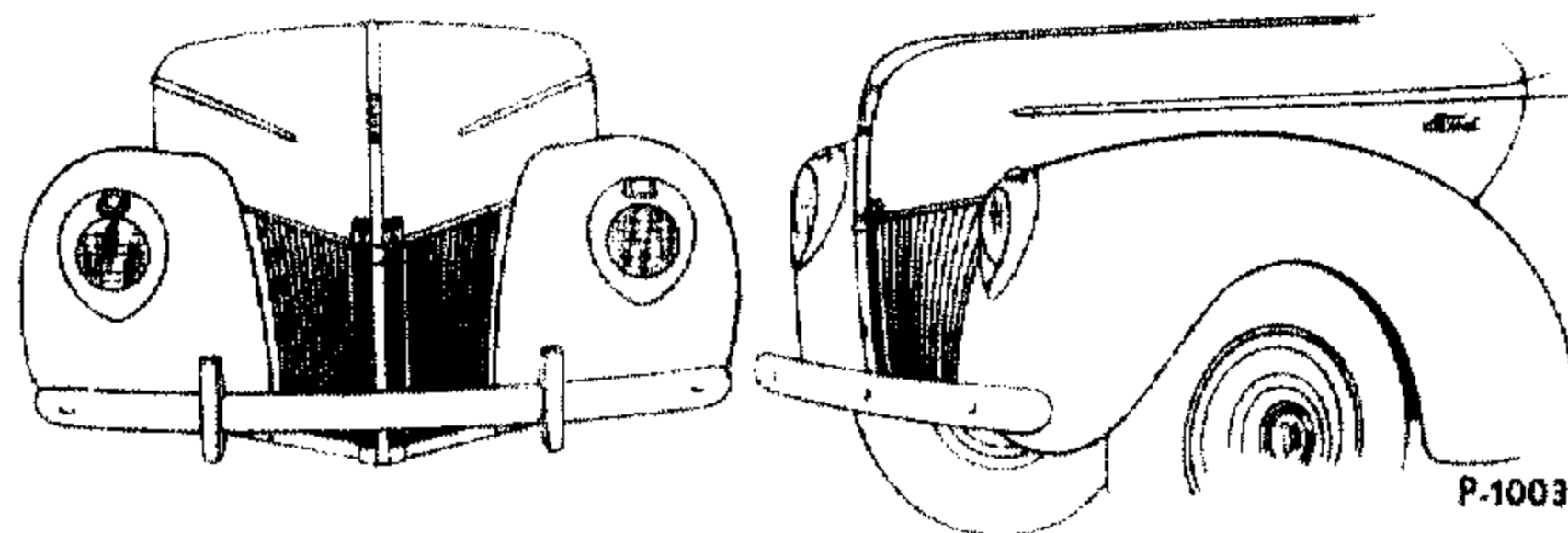

P-1003

FORD COMMERCIAL

60 HP.	*85 HP.	**95 HP.	WHEELBASE
02C	01C	09C	112"

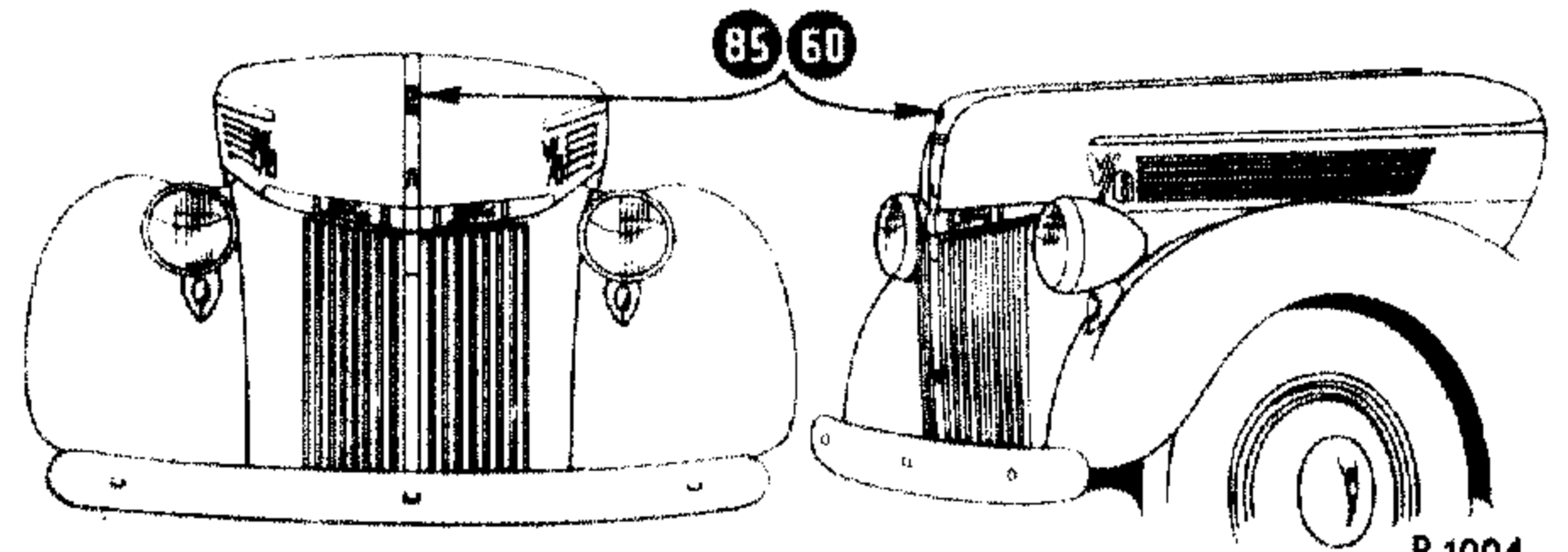

P-1004

FORD 3/4 TON TRUCK

60 HP.	*85 HP.	**95 HP.	WHEELBASE
02D	01D	09D	122"

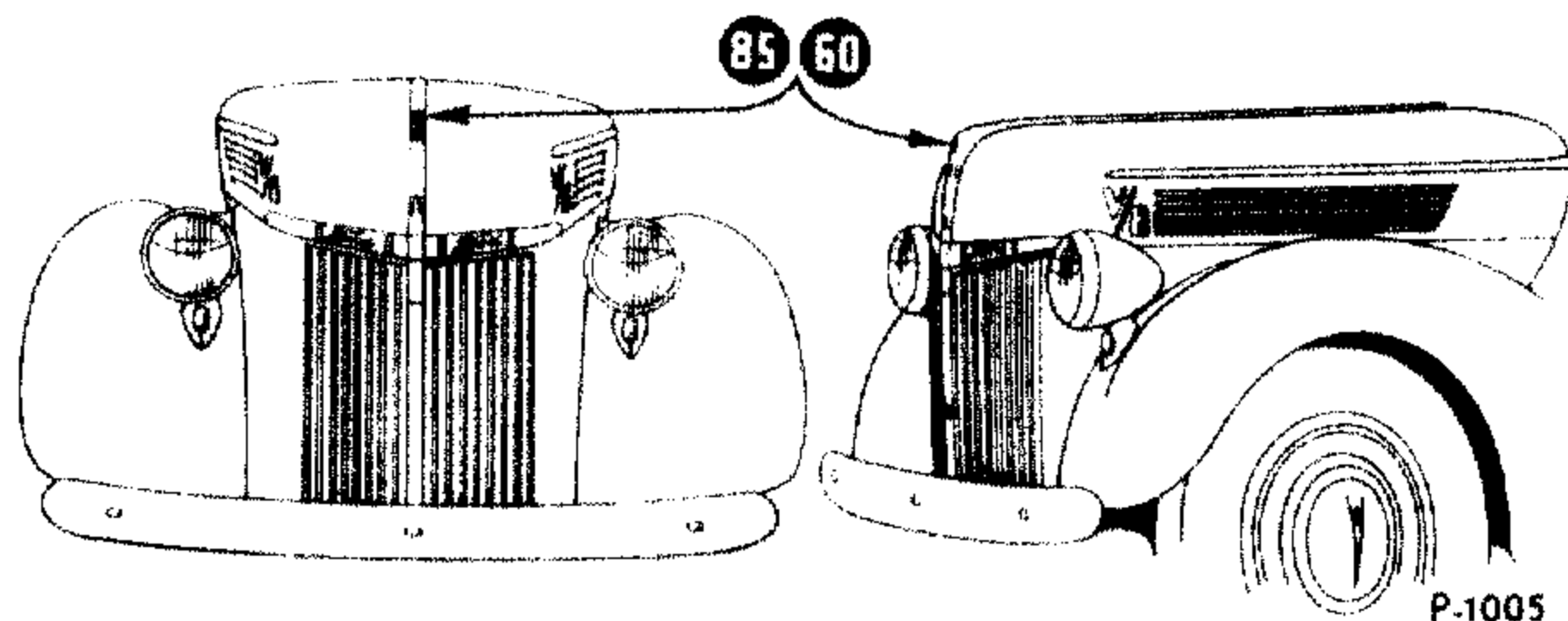

P-1005

FORD 1 TON TRUCK

60 HP.	*85 HP.	**95 HP.	WHEELBASE
02Y	01Y	09Y	122"

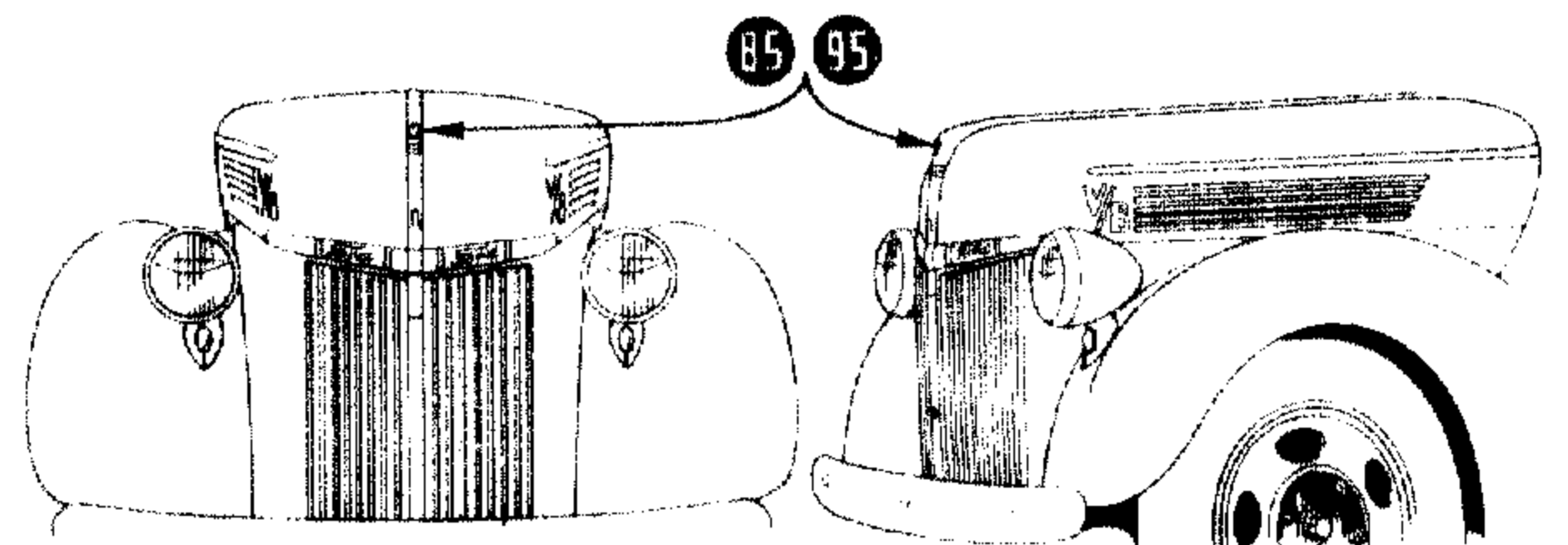

P-1006

FORD REGULAR TRUCK

MODEL	*85 HP.	**95 HP.	WHEELBASE
01T	09T		134"
018T	098T		158"
§ 01U	§ 09U		134"
◇ 014T	◇ 094T		194"

◇ School Bus Chassis
§ Dump Chassis

FORD CAB-OVER-ENGINE →

MODEL	*85 HP.	**95 HP.	WHEELBASE
011W	091W		101"
01W	09W		134"
018W	098W		158"

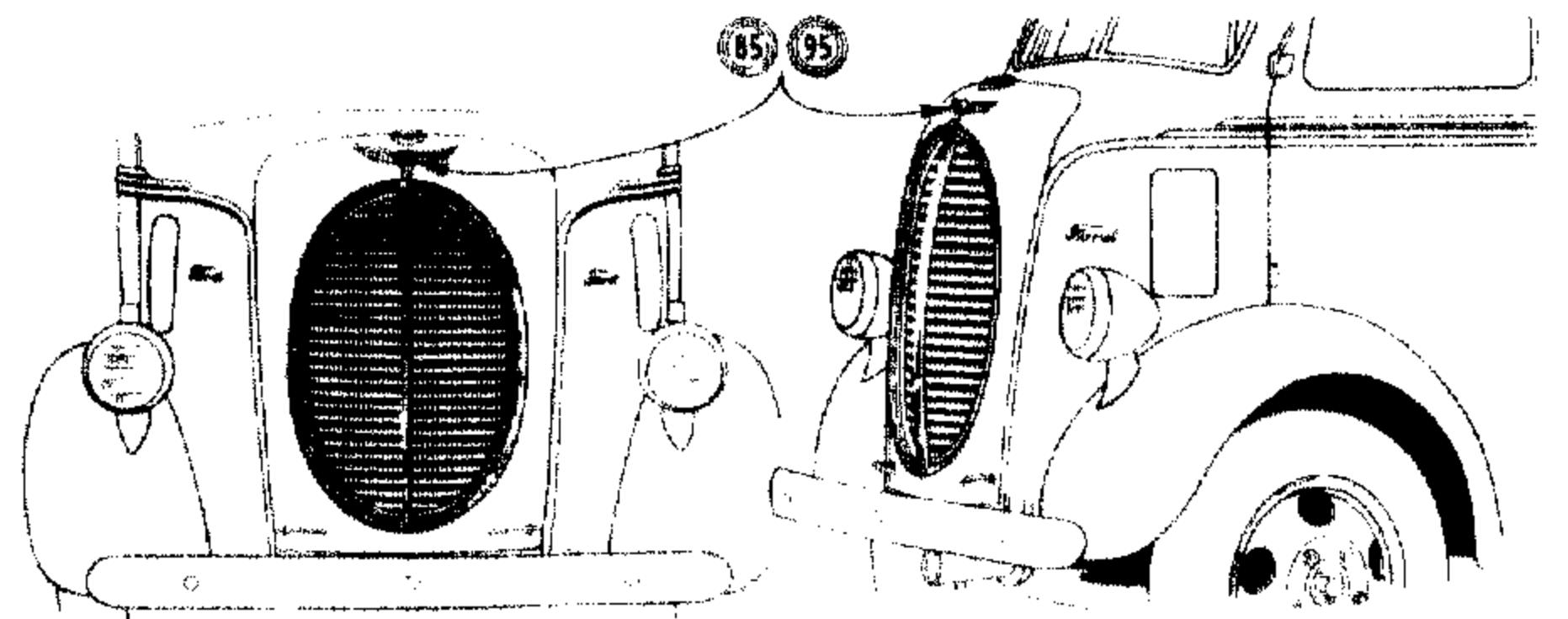

P-1007

BODY TYPE	NAME	BODY TYPE	NAME
80	Platform (112" Wheelbase)	81	Closed Cab (Cab-Over-Engine)
80	Platform (3/4 Ton) (122" Wheelbase)	82-A	Panel Delivery (with slats) (112" Wheelbase)
80	Platform (1 Ton) (122" Wheelbase)	82-B	Panel Delivery (with masonite) (112" Wheelbase)
80	Platform (134" Reg.) (101" Cab-Over-Engine)	82	Panel Delivery (3/4 Ton) (122" Wheelbase)
80	Platform (134" Cab-Over-Engine)	82	Panel Delivery (1 Ton) (122" Wheelbase)
80	Platform (158" Wheelbase—Reg.)	82	Panel Delivery (134" Wheelbase)
81	Closed Cab (112" Wheelbase)	83	Pickup (112" Wheelbase)
81	Closed Cab (122", 134", 158" Wheelbase—Reg.)	83	Express (3/4 Ton) (122" Wheelbase)
	*Listed throughout Catalogue as 90 HP.	83	Express (1 Ton) (122" Wheelbase)
	**Listed throughout Catalogue as 100 HP.		

1941

FORD PASSENGER CAR MODELS

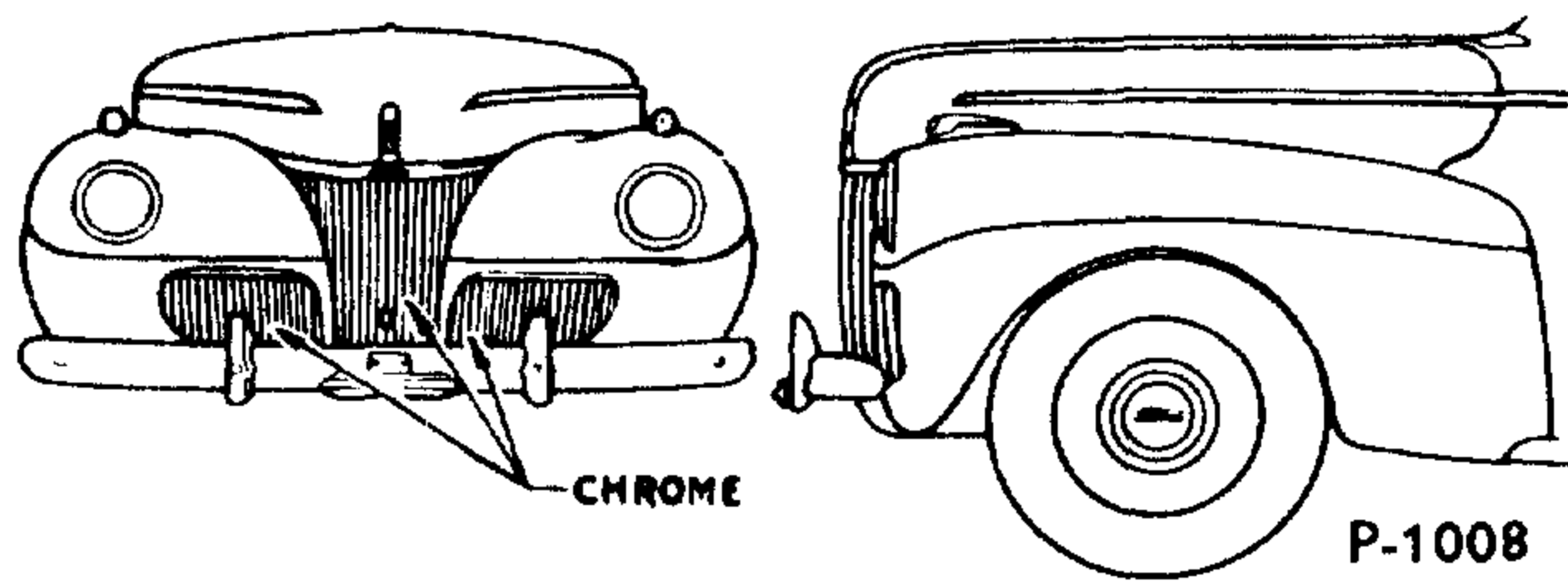

MODEL 11A FORD SUPER DELUXE
90 HP. 8-Cylinder Engine
 (114" Wheelbase)

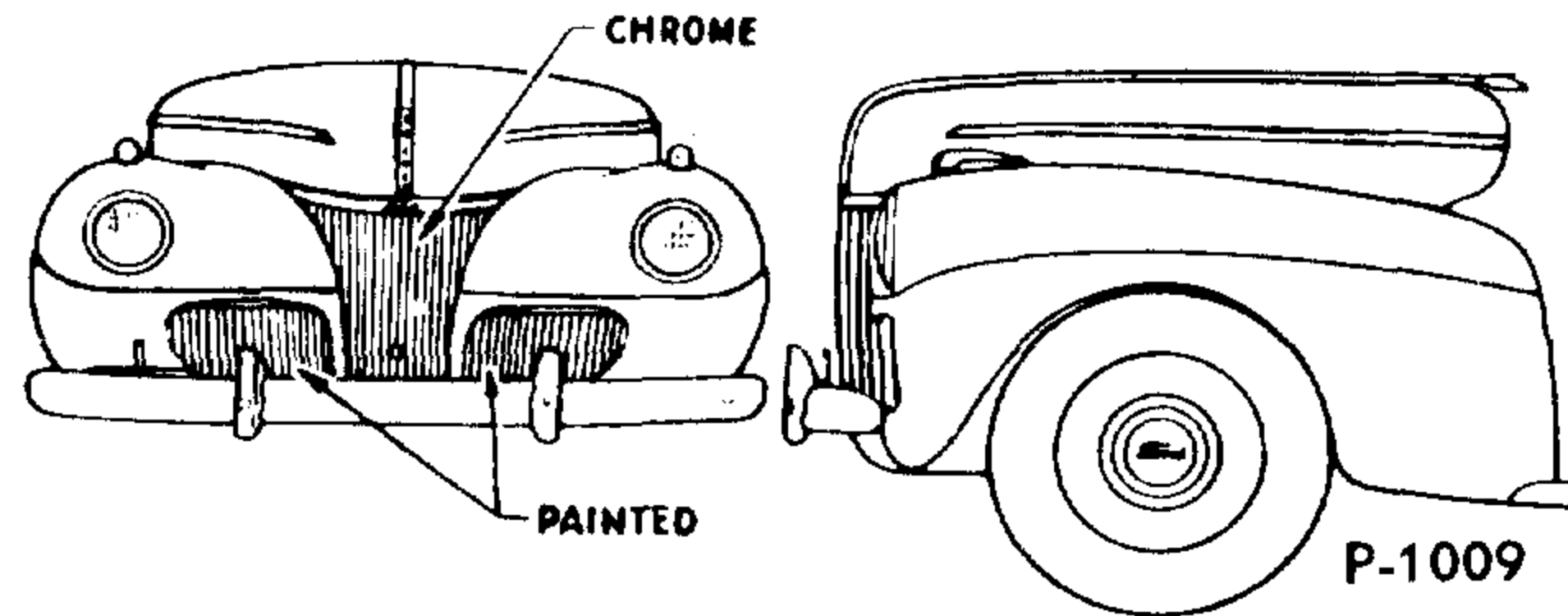

MODEL 11A FORD DELUXE
90 HP. 8-Cylinder Engine

MODEL 11A FORD SPECIAL
90 HP. 8-Cylinder Engine

MODEL 1GA FORD DELUXE
90 HP. 6-Cylinder Engine

MODEL 1GA FORD SPECIAL
90 HP. 6-Cylinder Engine
 (114" Wheelbase)

BODY TYPE	N A M E	BODY TYPE	N A M E
67-A	De Luxe Coupe (with auxiliary seats)	73-B	Super De Luxe Fordor Sedan
67-B	Super De Luxe Coupe (with auxiliary seats)	73-C	Special Fordor Sedan
70-A	De Luxe Tudor Sedan	76	Super De Luxe Convertible Club Coupe
70-B	Super De Luxe Tudor Sedan	77-A	De Luxe (5-Window) Coupe
70-C	Special Tudor Sedan	77-B	Super De Luxe (5-Window) Coupe
72	Super De Luxe Sedan Coupe	77-C	Special Coupe (5-Window)
73-A	De Luxe Fordor Sedan	79-A	De Luxe Station Wagon
		79-B	Super De Luxe Station Wagon

1941 FORD COMMERCIAL AND TRUCK MODELS

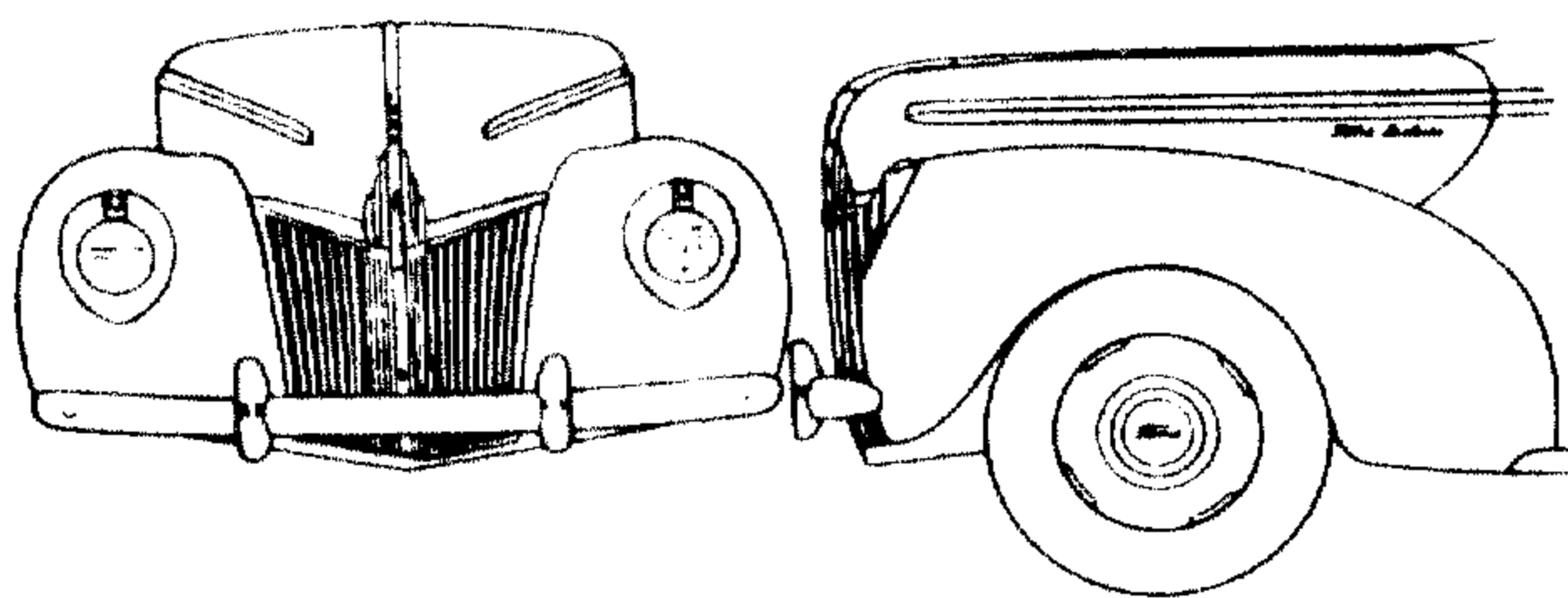

P-1010

FORD COMMERCIAL
(112" Wheelbase)

MODEL	ENGINE	HP.
11C	8 cylinder.....	90
1GC	6 cylinder.....	90
1NC	4 cylinder.....	40
19C	8 cylinder.....	100

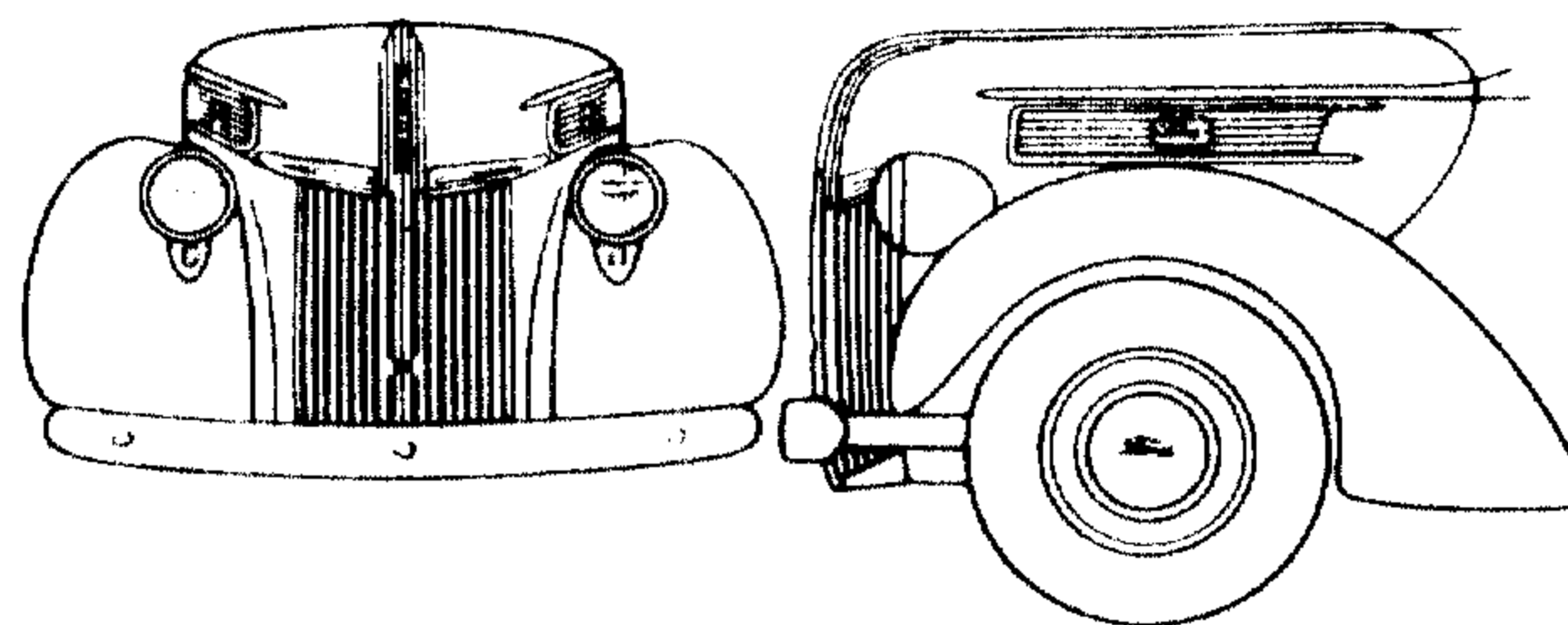

P-1011

FORD 3/4 TON TRUCK
(122" Wheelbase)

MODEL	ENGINE	HP.
11D	8 cylinder.....	90
1GD	6 cylinder.....	90
1ND	4 cylinder.....	40
19D	8 cylinder.....	100

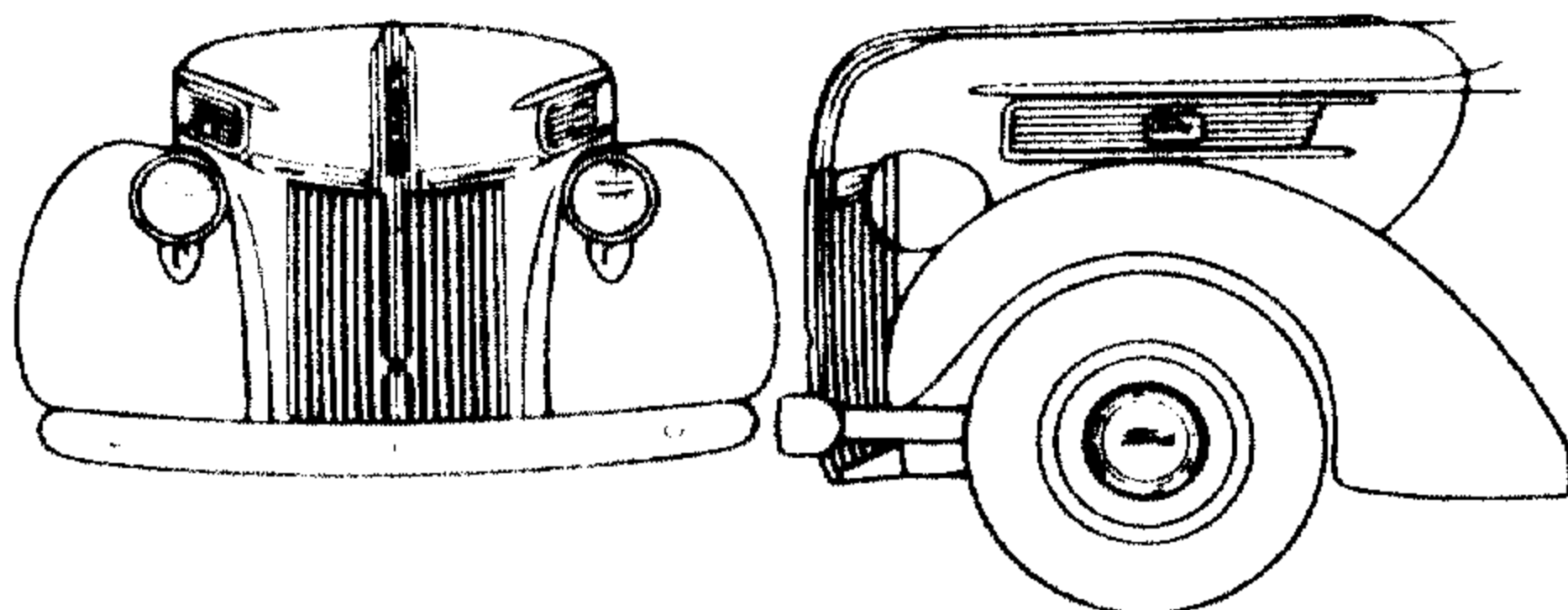

P-1012

FORD 1 TON TRUCK
(122" Wheelbase)

MODEL	ENGINE	HP.
11Y	8 cylinder.....	90
1GY	6 cylinder.....	90
1NY	4 cylinder.....	40
19Y	8 cylinder.....	100

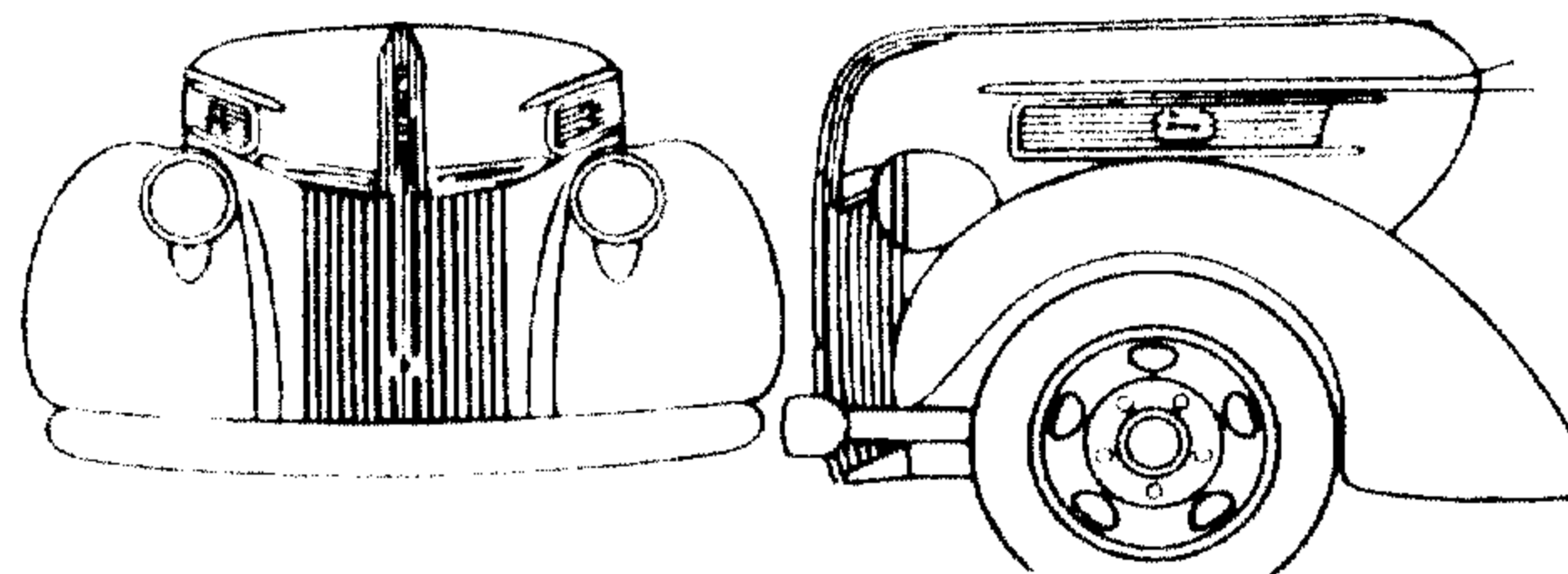

P-1013

FORD REGULAR TRUCK

MODEL and ENGINE			WHEELBASE
8 Cylinder 90 HP.	8 Cylinder 100 HP.	6 Cylinder 90 HP.	
11T	19T	1GT.....	134"
118T	198T	1G8T.....	158"
§ 11U	§ 19U	§1GU.....	134"
◇114T	◇194T	◇1G4T.....	194"
§Dump Chassis		◇School Bus Chassis	

FORD CAB-OVER-ENGINE →

MODEL and ENGINE		WHEELBASE
8 Cylinder 90 HP.	8 Cylinder 100 HP.	
111W	191W.....	101"
11W	19W.....	134"
118W	198W.....	158"

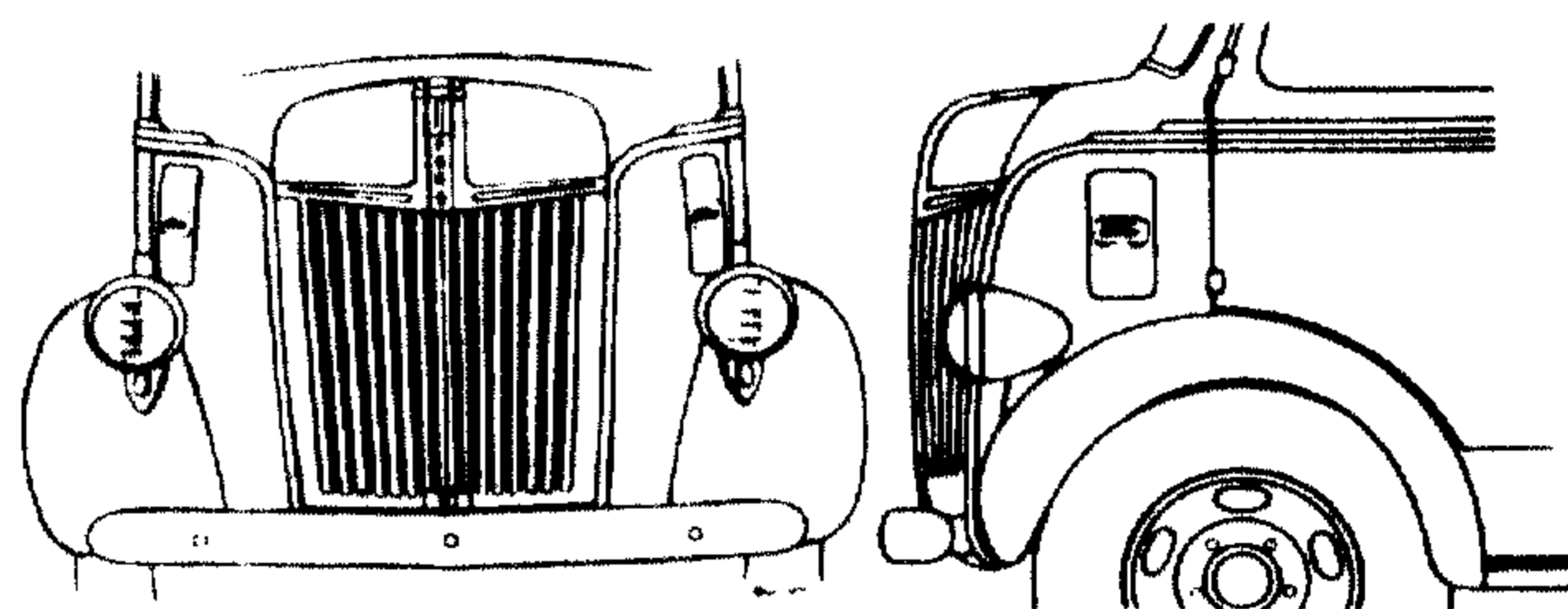

P-1014

BODY TYPE	NAME	BODY TYPE	NAME
78	Sedan Delivery (112" Wheelbase)	81	Closed Cab (101", 134", 158" Cab-Over-Engine)
80	Platform (112" Wheelbase)	82-A	Panel Delivery (with slats) (112" Wheelbase)
80	Platform (3/4 Ton) (122" Wheelbase)	82-B	Panel Delivery (with masonite) (112" Wheelbase)
80	Platform (1 Ton) (122" Wheelbase)	82	Panel Delivery (3/4 Ton) (122" Wheelbase)
80	Platform (134" Reg.) (101" Cab-Over-Engine)	82	Panel Delivery (1 Ton) (122" Wheelbase)
80	Platform (134" Cab-Over-Engine)	82	Panel Delivery (134" Wheelbase)
80	Platform (158" Wheelbase)	83	Pickup (112" Wheelbase)
81	Closed Cab (112" Wheelbase)	83	Express (3/4 Ton) (122" Wheelbase)
81	Closed Cab (122", 134", 158" Wheelbase)	83	Express (1 Ton) (122" Wheelbase)

1942

FORD PASSENGER CAR MODELS

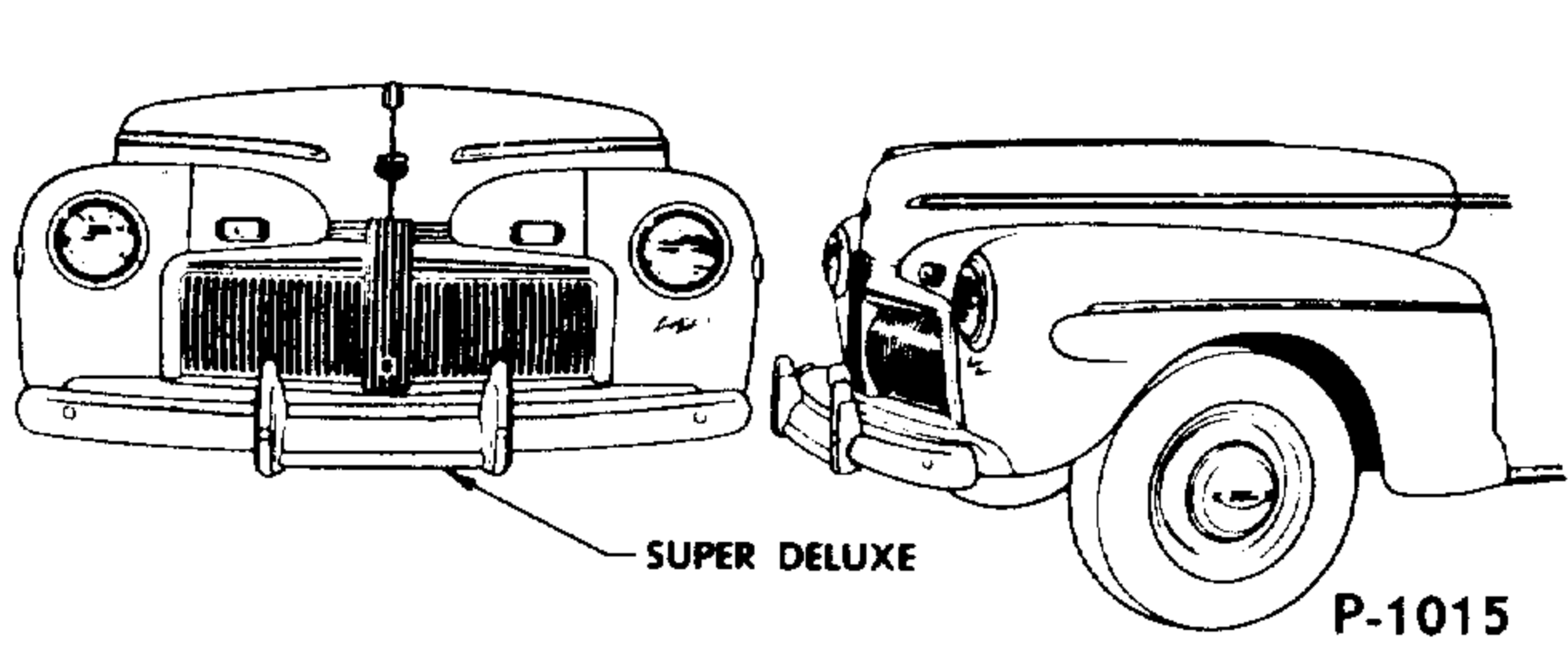

MODEL 21A FORD SUPER DELUXE
 90 HP. 8-Cylinder Engine
 (114" Wheelbase)

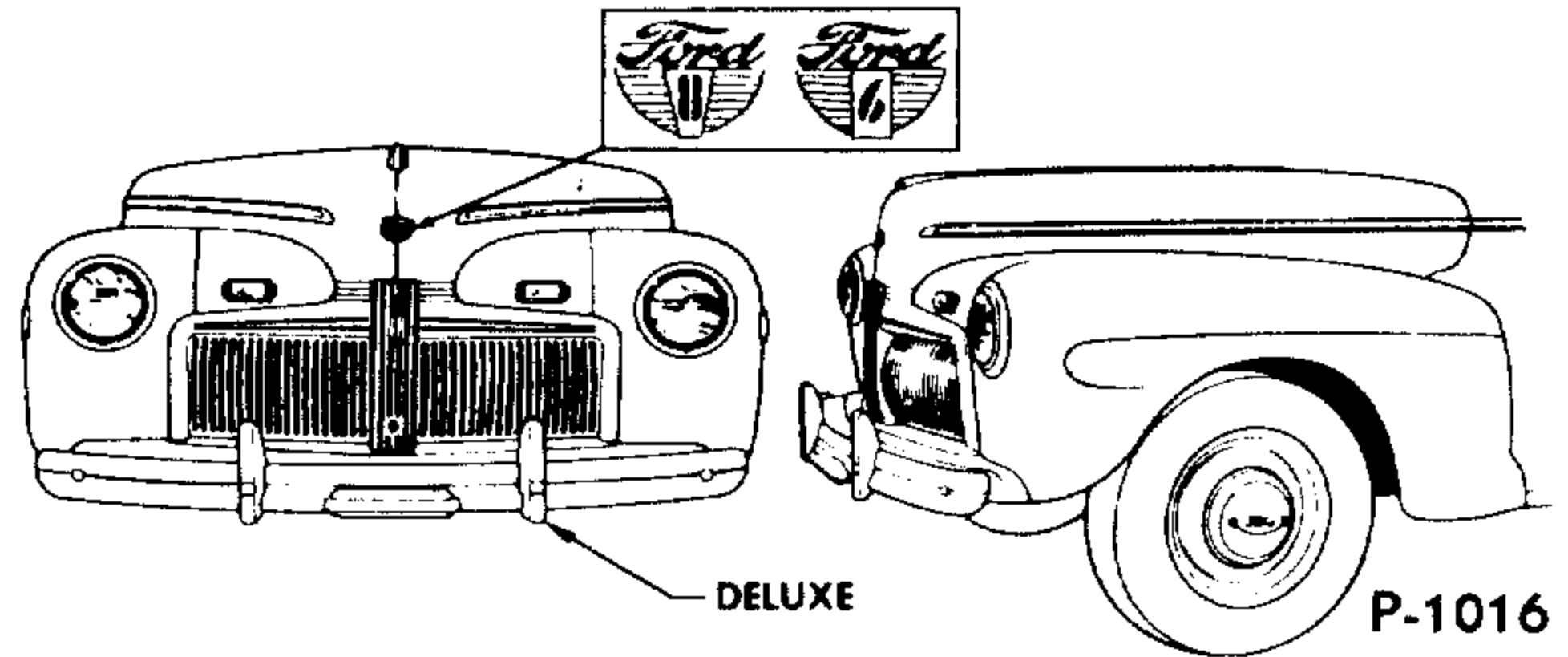

MODEL 21A FORD DELUXE
 90 HP. 8-Cylinder Engine
MODEL 2GA FORD DELUXE
 90 HP. 6-Cylinder Engine
 (114" Wheelbase)

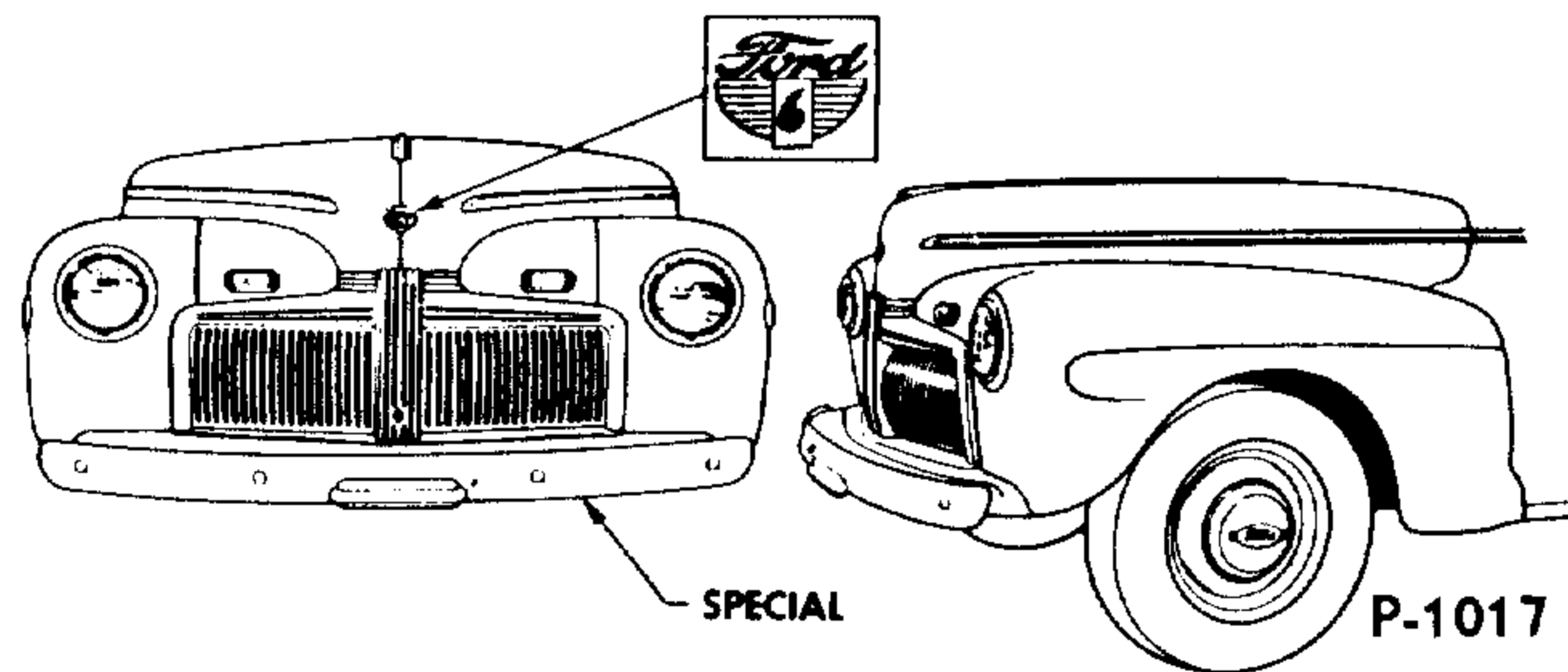

MODEL 2GA FORD SPECIAL
 90 HP. 6-Cylinder Engine
 (114" Wheelbase)

BODY TYPE	N A M E	BODY TYPE	N A M E
70-A	De Luxe Tudor Sedan	73-C	Special Fordor Sedan
70-B	Super De Luxe Tudor Sedan	76	Super De Luxe Convertible Club Coupe
70-C	Special Tudor Sedan	77-A	De Luxe (5-Window) Coupe
72-A	De Luxe Sedan Coupe	77-B	Super De Luxe (5-Window) Coupe
72-B	Super De Luxe Sedan Coupe	77-C	Special Coupe (5-Window)
73-A	De Luxe Fordor Sedan	78	De Luxe Sedan Delivery
73-B	Super De Luxe Fordor Sedan	79-B	Super De Luxe Station Wagon

1942 FORD COMMERCIAL AND TRUCK MODELS

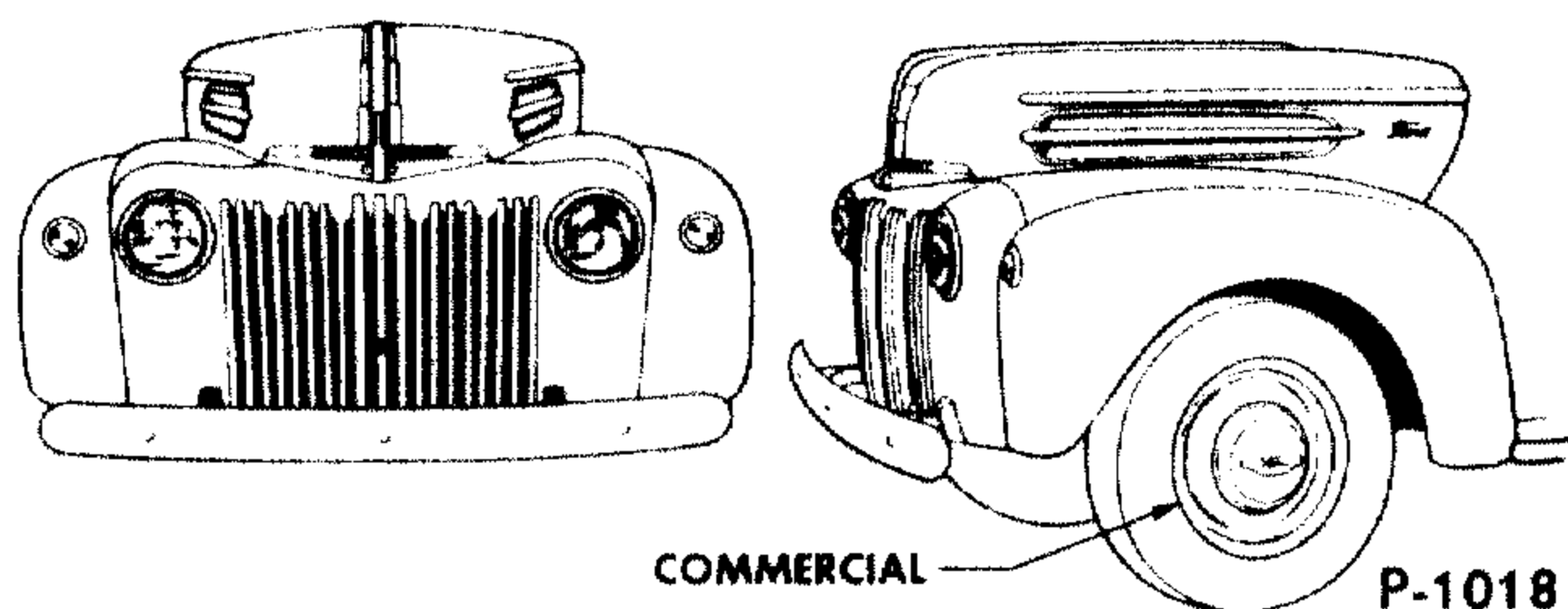

COMMERCIAL P-1018

FORD COMMERCIAL OR LIGHT TRUCK (114" Wheelbase)

MODEL	ENGINE	HP.
29C	8 cylinder.....	100
21C	8 cylinder.....	90
2GC	6 cylinder.....	90
2NC	4 cylinder.....	40

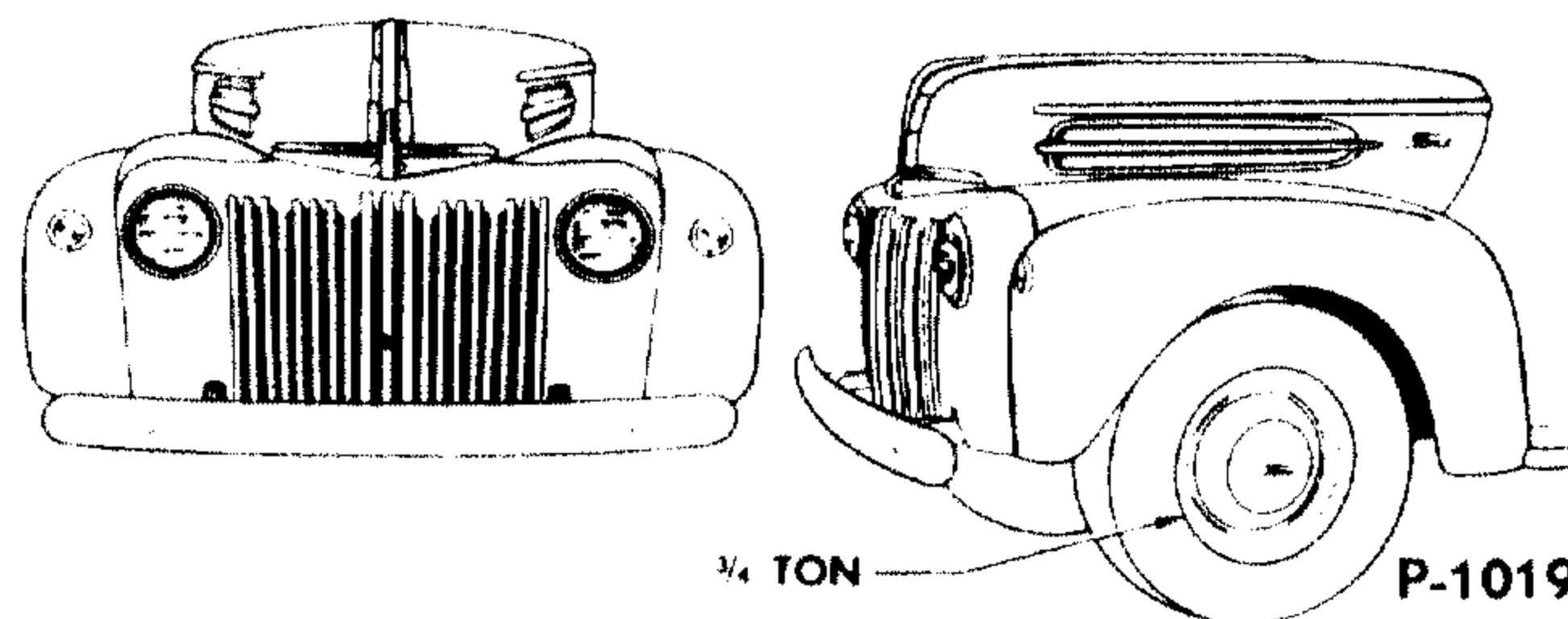

3/4 TON P-1019

FORD 3/4 TON TRUCK (122" Wheelbase)

MODEL	ENGINE	HP.
29D	8 cylinder.....	100
21D	8 cylinder.....	90
2GD	6 cylinder.....	90
2ND	4 cylinder.....	40

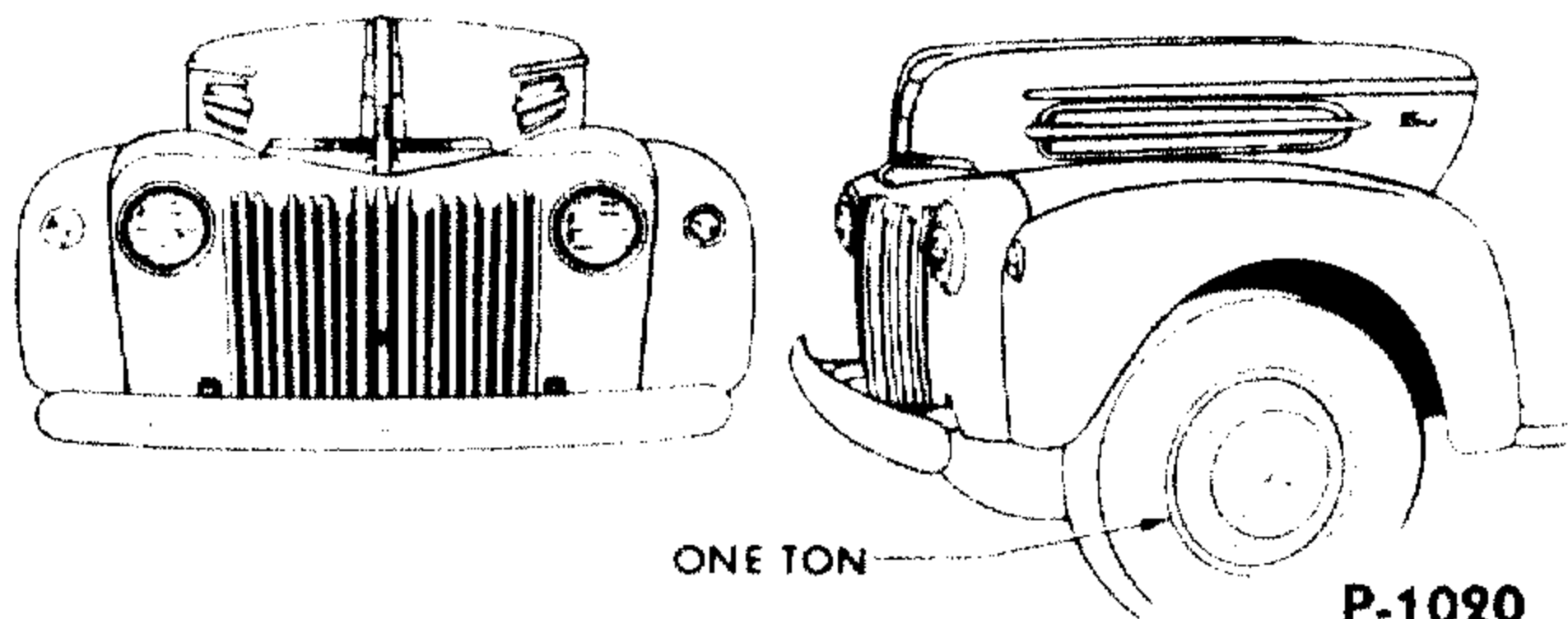

ONE TON P-1020

FORD 1 TON TRUCK (122" Wheelbase)

MODEL	ENGINE	HP.
21Y	8 cylinder.....	90
2GY	6 cylinder.....	90
2NY	4 cylinder.....	40
29Y	8 cylinder.....	100

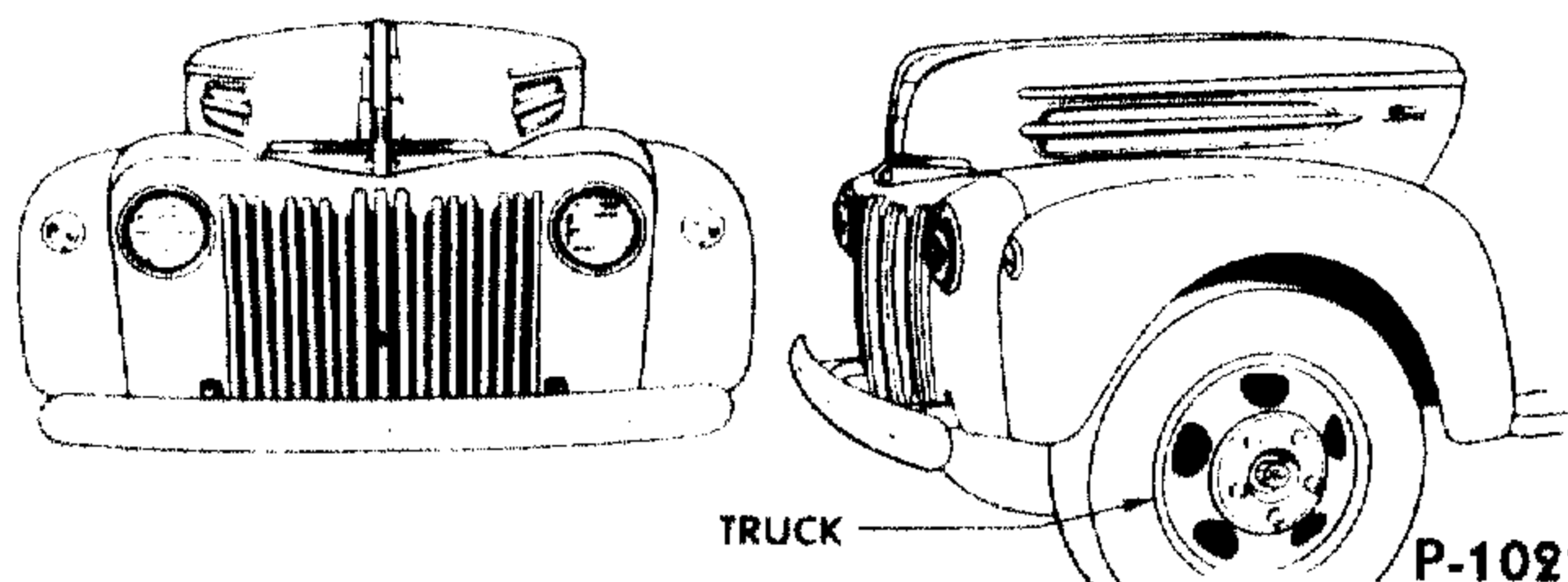

TRUCK P-1021

FORD REGULAR TRUCK

MODEL and ENGINE			WHEELBASE
8 Cylinder 90 HP.	8 Cylinder 100 HP.	6 Cylinder 90 HP.	
21T	29T	2GT	134"
218T	298T	2G8T	158"
§ 21U	§ 29U	§ 2GU	134"
◇ 294T	◇ 294T	◇ 2G4T	194"
§ Dump Chassis		◇ School Bus Chassis	

FORD CAB-OVER-ENGINE →

MODEL and ENGINE		WHEELBASE
8 Cylinder 90 HP.	8 Cylinder 100 HP.	
211W	291W	101"
21W	29W	134"
218W	298W	158"

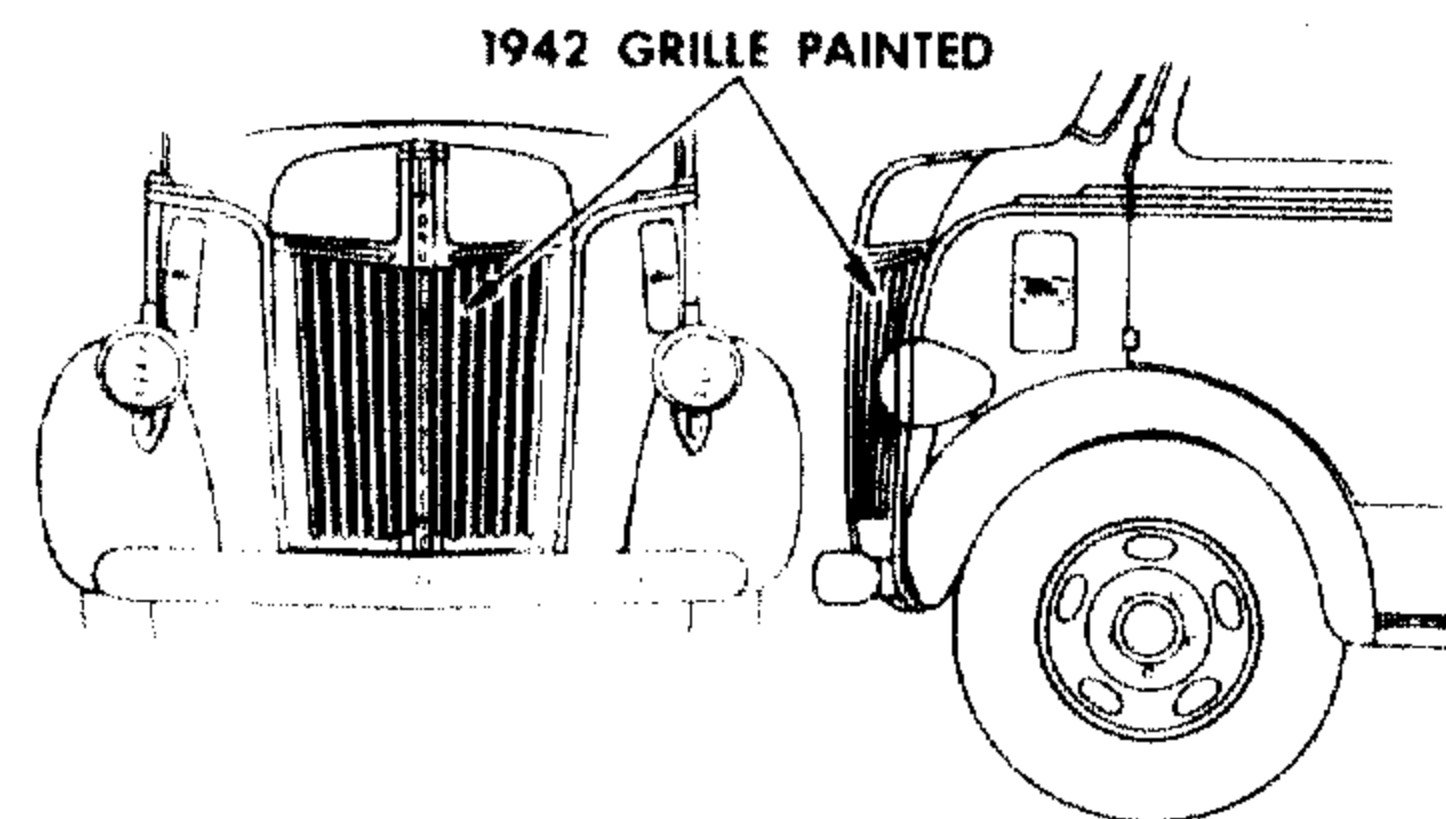

1942 GRILLE PAINTED

P-1022

BODY TYPE	NAME	BODY TYPE	NAME
80	Platform (114" Wheelbase)	82-A	Panel Delivery (with slats) (114" Wheelbase)
80	Platform (3/4 Ton) (122" Wheelbase)	82-B	Panel Delivery (with masonite) (114" Wheelbase)
80	Platform (1 Ton) (122" Wheelbase)	82	Panel Delivery (3/4 Ton) (122" Wheelbase)
80	Platform (134" Regular and 101" Cab-Over-Engine)	82	Panel Delivery (1 Ton) (122" Wheelbase)
80	Platform (134" Cab-Over-Engine)	82	Panel Delivery (134" Wheelbase)
80	Platform (158" Wheelbase)	83	Pickup (114" Wheelbase)
81	Closed Cab (114" Wheelbase)	83	Express (3/4 Ton) (122" Wheelbase)
81	Closed Cab (122", 134", 158" Wheelbase)	83	Express (1 Ton) (122" Wheelbase)
81	Closed Cab (101", 134", 158" Cab-Over-Engine)		

1943

NO CIVILIAN PASSENGER CARS OR TRUCKS WERE
MANUFACTURED DURING THE YEAR 1943.

1944

FORD TRUCK MODELS

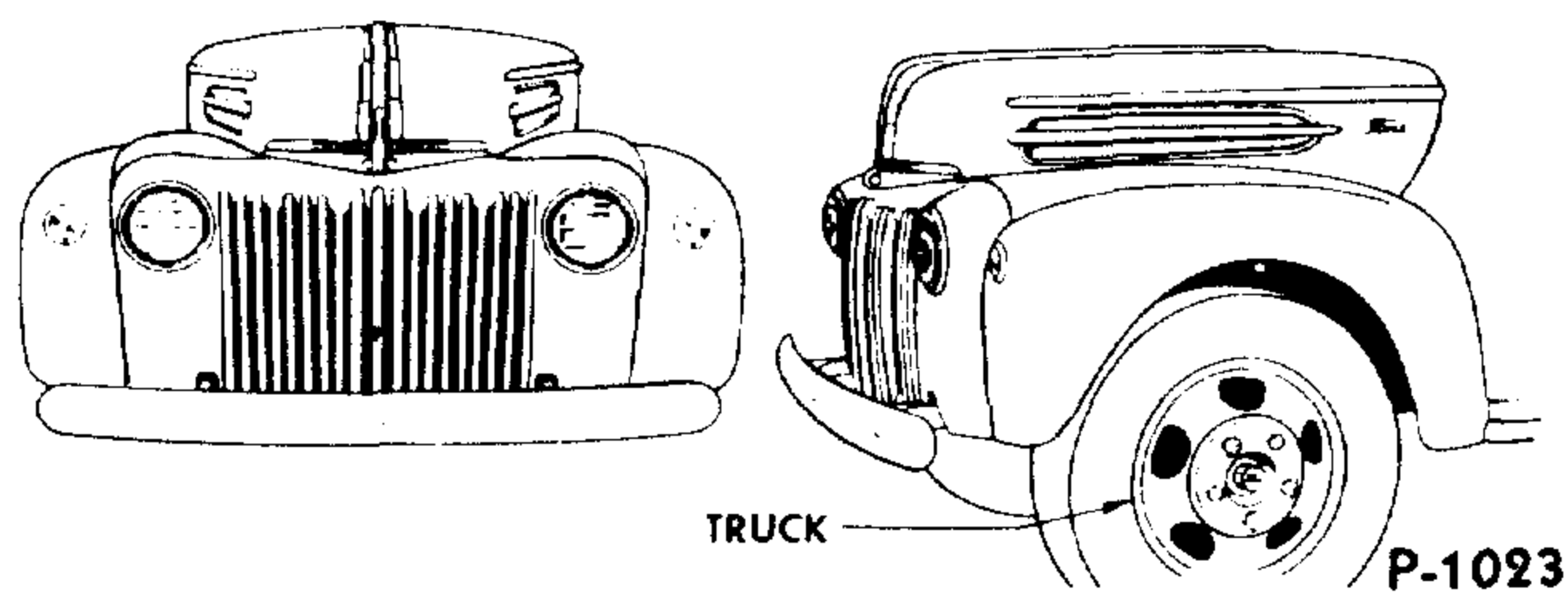

FORD REGULAR TRUCK

MODEL		WHEELBASE
498T	8 cylinder, 100 HP.....	158"
◇494T	8 cylinder, 100 HP.....	194"
◇School Bus Chassis		

BODY TYPE	NAME
81	Closed Cab (158" Wheelbase)

1945

FORD COMMERCIAL AND TRUCK MODELS

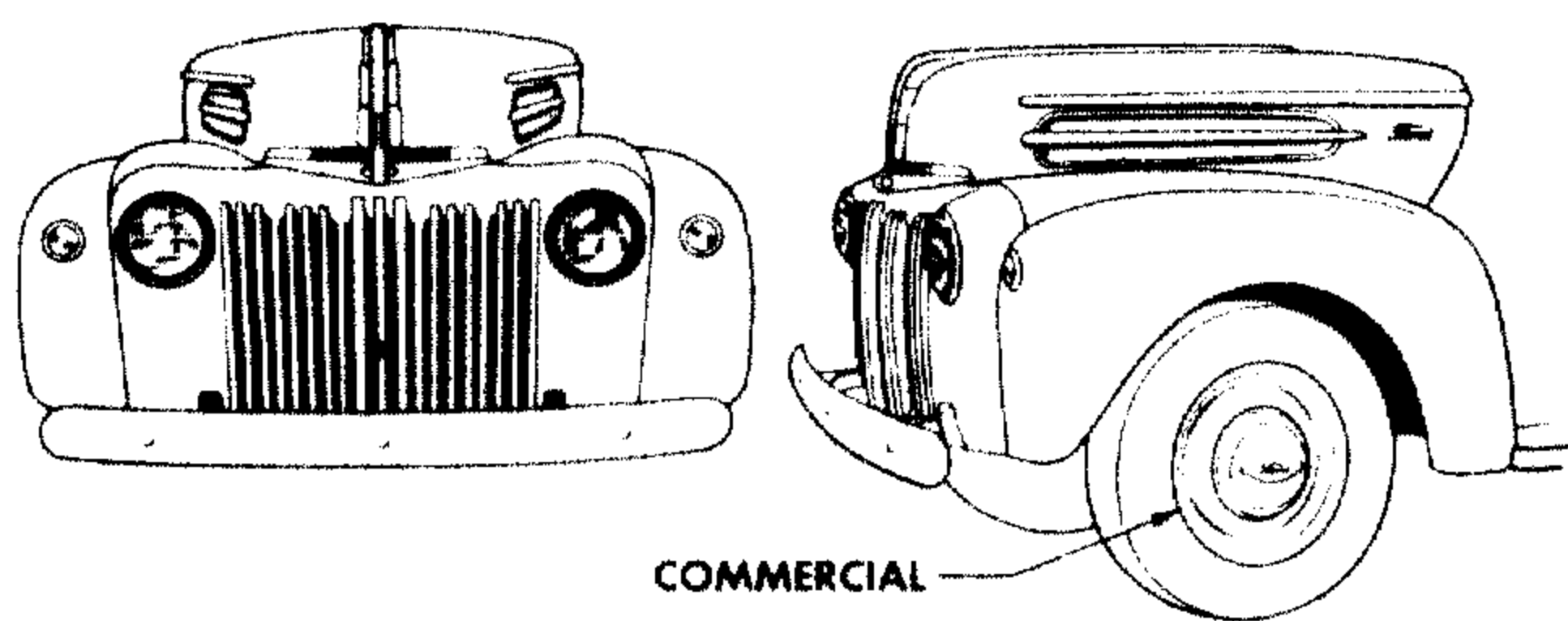

COMMERCIAL

P-1024

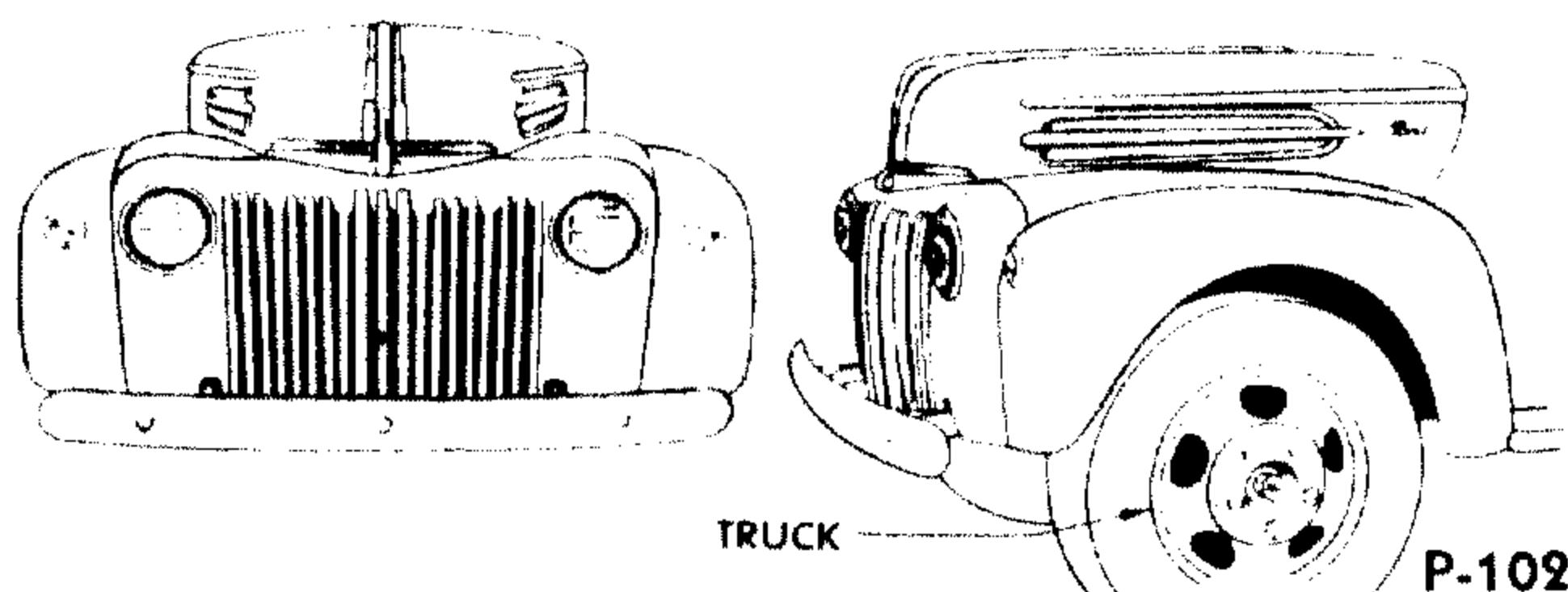

TRUCK

P-1025

FORD COMMERCIAL OR LIGHT TRUCK (114" Wheelbase)

MODEL	ENGINE	HP.
59C	8 cylinder	100

FORD REGULAR TRUCK

MODEL and ENGINE	WHEELBASE
59T 8 cylinder 100 HP.	134"
598T 8 cylinder 100 HP.	158"
594T 8 cylinder 100 HP.	194"
School Bus Chassis	

BODY TYPE	NAME	BODY TYPE	NAME
80	Platform (114" Wheelbase)	81	Closed Cab (134" Wheelbase)
80	Platform (134" Wheelbase)	81	Closed Cab (158" Wheelbase)
80	Platform (158" Wheelbase)	82-A	Panel Delivery (with slats) (114" Wheelbase)
81	Closed Cab (114" Wheelbase)	83	Pickup (114" Wheelbase)



1946

FORD PASSENGER CAR MODELS

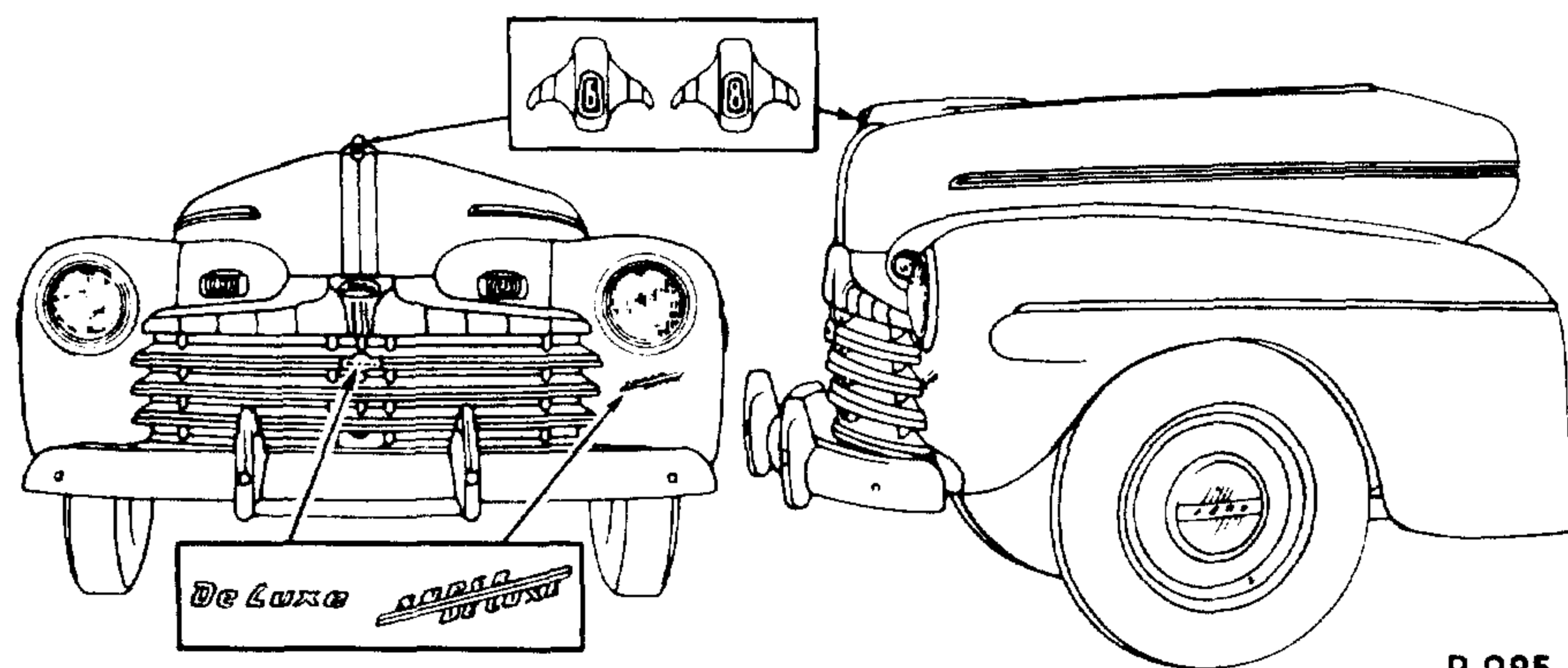

P-925

MODEL 69A FORD DELUXE OR SUPER DELUXE—100 HP. 8-Cylinder Engine

MODEL 6GA FORD DELUXE OR SUPER DELUXE—90 HP. 6-Cylinder Engine

(114" Wheelbase)

BODY TYPE	NAME	BODY TYPE	NAME
70-A	De Luxe Tudor Sedan	76	Super De Luxe Convertible Club Coupe
70-B	Super De Luxe Tudor Sedan	77-A	De Luxe (5-Window) Coupe
71	Sportsman Coupe	77-B	Super De Luxe (5-Window) Coupe
72-B	Super De Luxe Sedan Coupe	78	De Luxe Sedan Delivery
73-A	De Luxe Fordor Sedan	79-B	Super De Luxe Station Wagon
73-B	Super De Luxe Fordor Sedan		



1946

FORD COMMERCIAL AND TRUCK MODELS

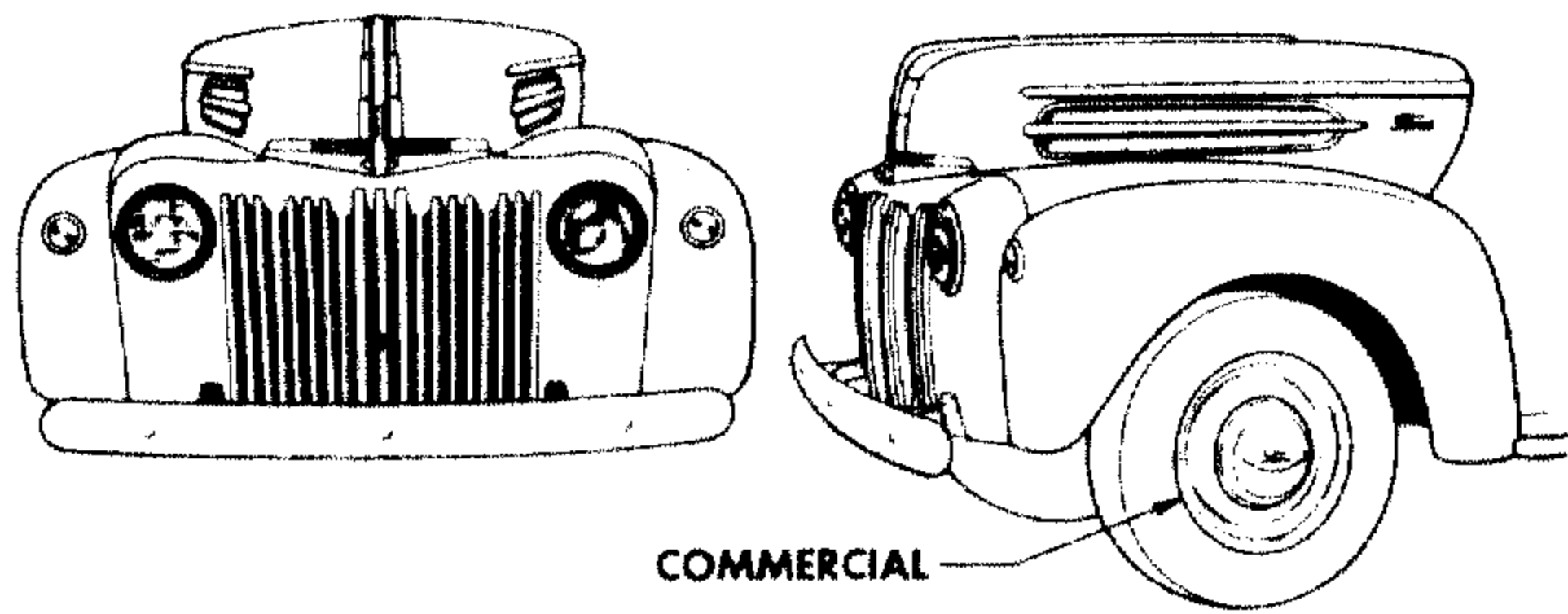

P-1026

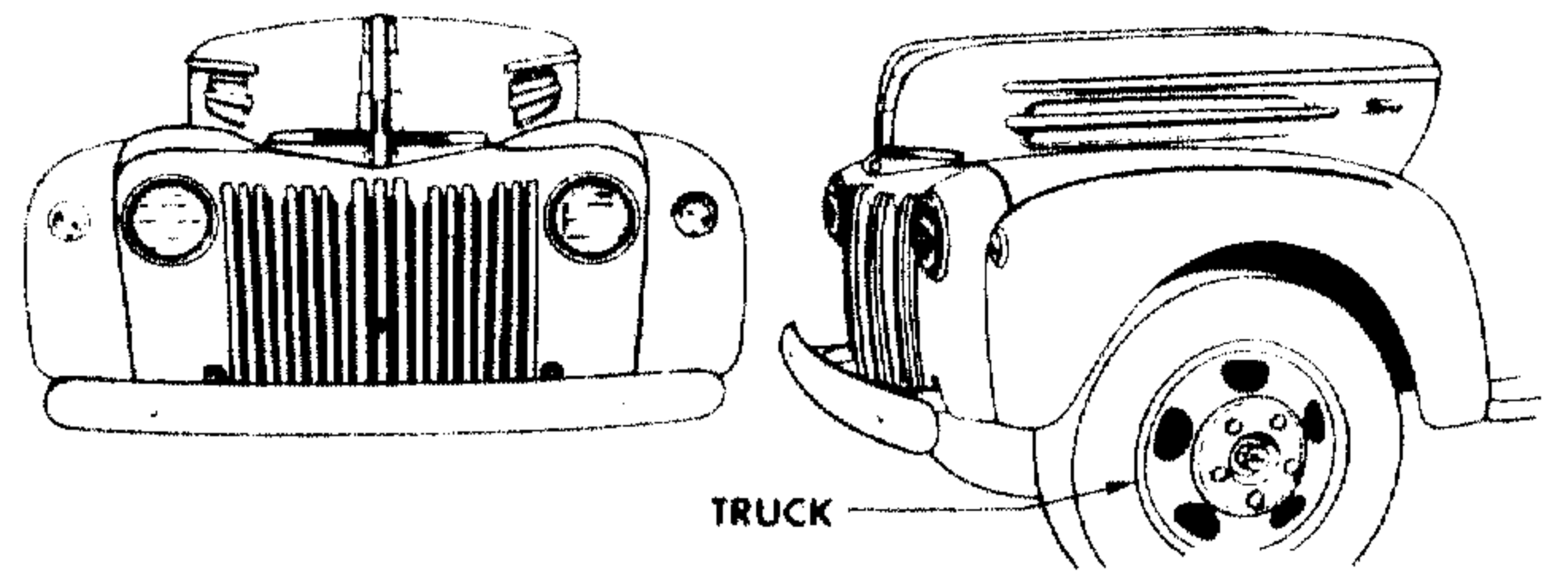

P-1028

FORD COMMERCIAL OR LIGHT TRUCK (114" Wheelbase)

MODEL	ENGINE	HP.
69C	8 cylinder	100
6GC	6 cylinder	90

FORD REGULAR TRUCK

MODEL and ENGINE		WHEELBASE
8 Cylinder 100 HP.	6 Cylinder 90 HP.	
69T	6GT	134"
698T	6G8T	158"
§ 69U	§6GU	134"
694T		194"

§Dump Chassis
⊙School Bus Chassis

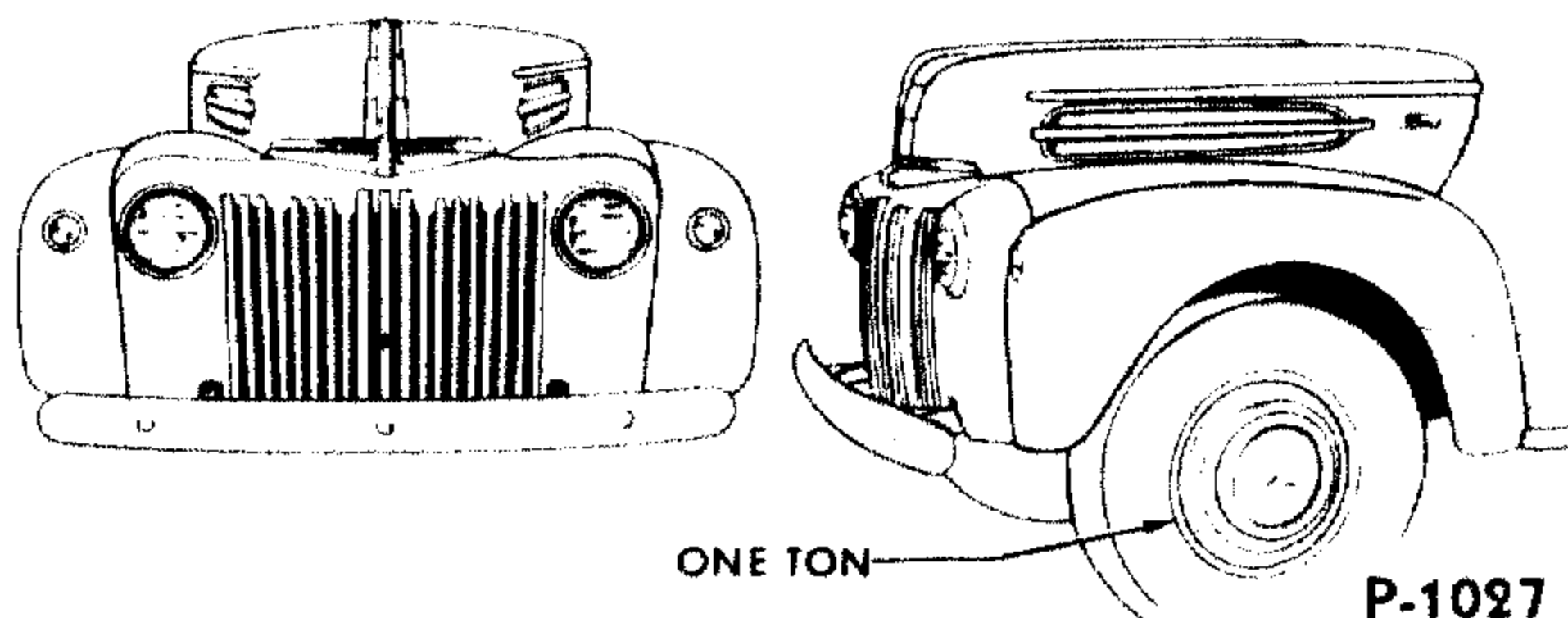

P-1027

FORD 1 TON TRUCK (122" Wheelbase)

MODEL	ENGINE	HP.
69Y	8 cylinder	100
6GY	6 cylinder	90

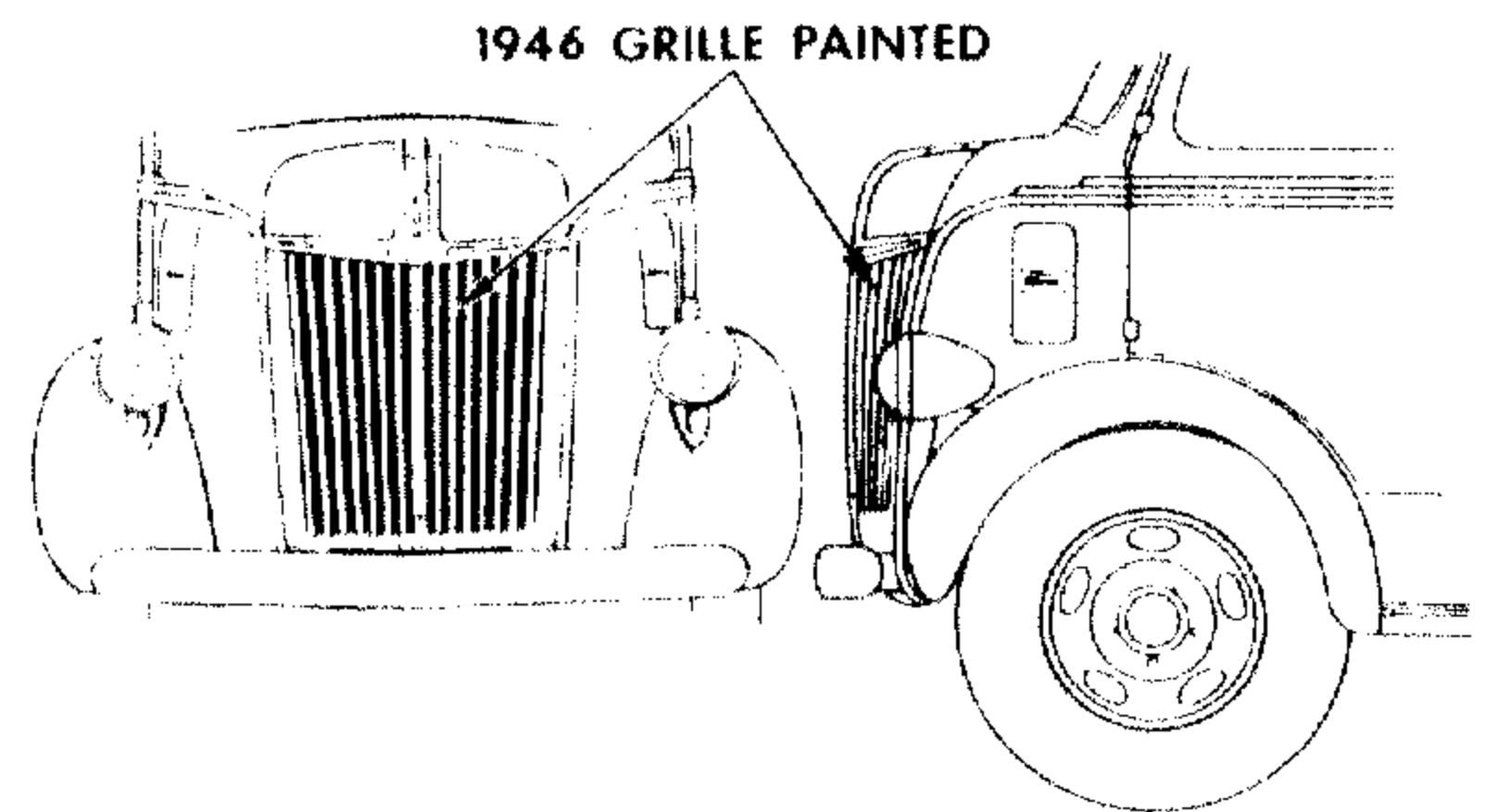

P-1029

FORD CAB-OVER-ENGINE

MODEL and ENGINE		WHEELBASE
8 Cylinder 100 HP.		
691W		101"
69W		134"
698W		158"

BODY TYPE	NAME	BODY TYPE	NAME
80	Platform (114" Wheelbase)	81	Closed Cab (122", 134", 158" Wheelbase)
80	Platform (1 Ton) (122" Wheelbase)	81	Closed Cab (101", 134", 158" Cab-Over-Engine)
80	Platform (134" Regular and 101" Cab-Over-Engine)	82-A	Panel Delivery (with slats) (114" Wheelbase)
80	Platform (134" Cab-Over-Engine)	82	Panel Delivery (1 Ton) (122" Wheelbase)
80	Platform (158" Wheelbase)	83	Pickup (114" Wheelbase)
81	Closed Cab (114" Wheelbase)	83	Express (1 Ton) (122" Wheelbase)

1947

FORD PASSENGER CAR MODELS

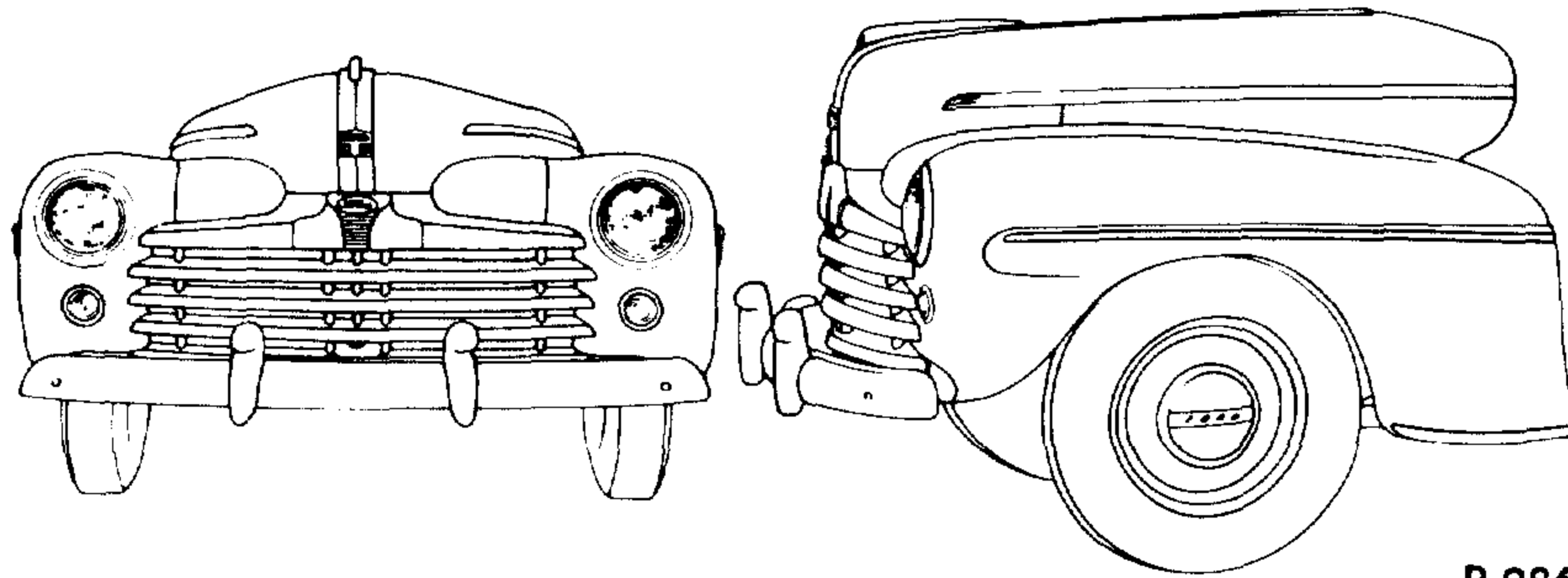

P-926

MODEL 79A FORD DELUXE OR SUPER DELUXE—100 HP. 8-Cylinder Engine

MODEL 7GA FORD DELUXE OR SUPER DELUXE—90 HP. 6-Cylinder Engine

**MODEL 7HA FORD DELUXE OR SUPER DELUXE—95 HP. 6-Cylinder Engine
(114" Wheelbase)**

BODY TYPE	N A M E	BODY TYPE	N A M E
70-A	De Luxe Tudor Sedan	76	Super De Luxe Convertible Club Coupe
70-B	Super De Luxe Tudor Sedan	77-A	De Luxe (5-Window) Coupe
71	Sportsman Coupe	77-B	Super De Luxe (5-Window) Coupe
72-B	Super De Luxe Sedan Coupe	78	De Luxe Sedan Delivery
73-A	De Luxe Fordor Sedan	79-B	Super De Luxe Station Wagon
73-B	Super De Luxe Fordor Sedan		



1947

FORD COMMERCIAL AND TRUCK MODELS

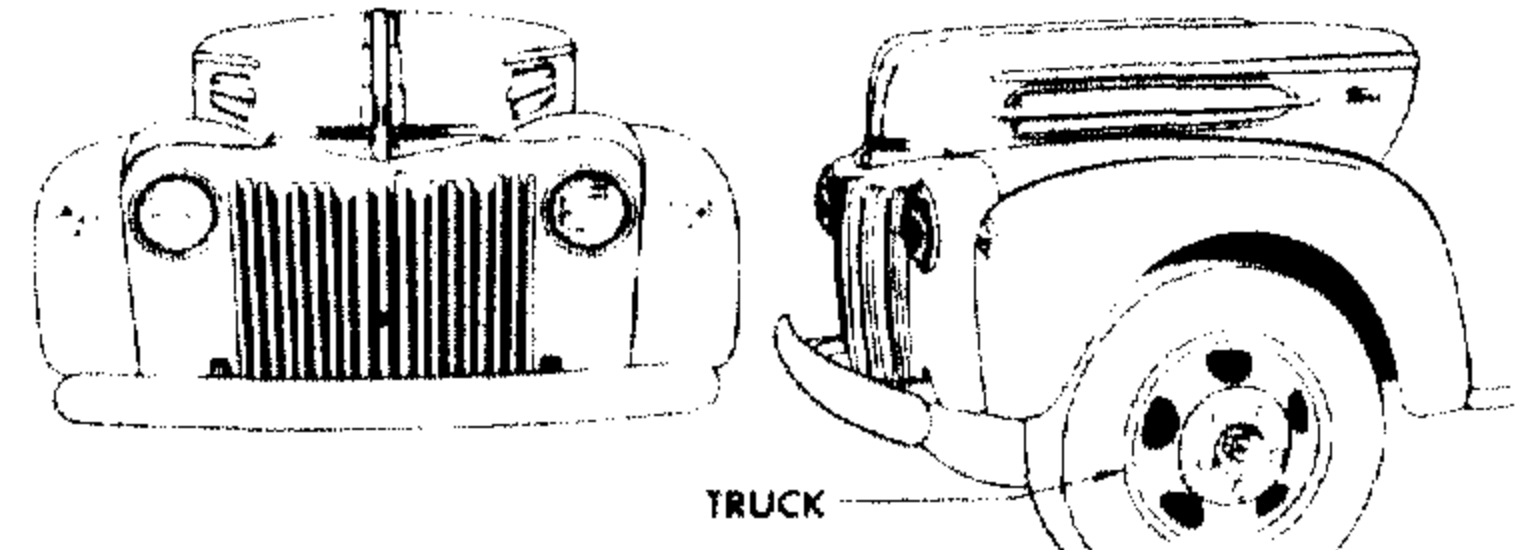
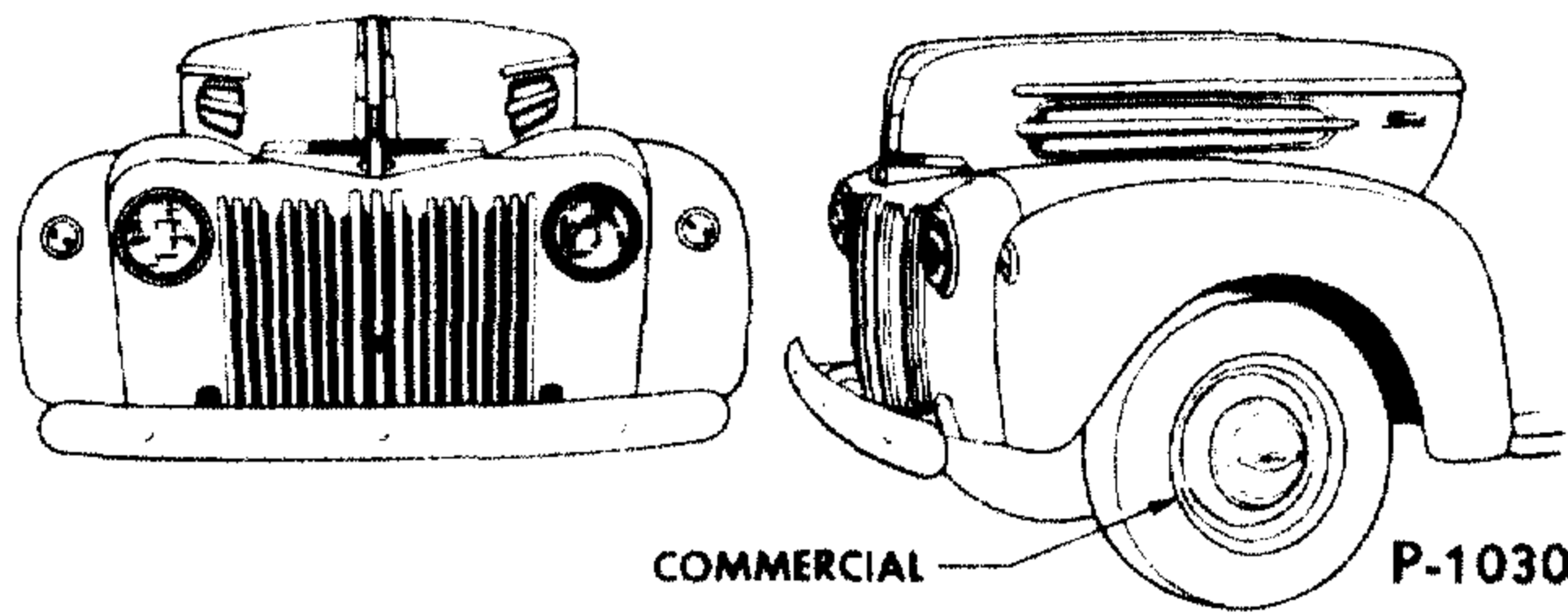

FORD COMMERCIAL OR LIGHT TRUCK

MODEL	ENGINE	HP.
79C	8 cylinder.....	100
7GC	6 cylinder.....	90
7HC	6 cylinder.....	95

FORD REGULAR TRUCK

MODEL	8 Cylinder 100 HP.	6 Cylinder 90 HP.	6 Cylinder 95 HP.	WHEELBASE
79T		7GT	7HT.....	134"
798T		768T	7H8T.....	158"
794T		7G4T	7H4T.....	194"

• School Bus Chassis

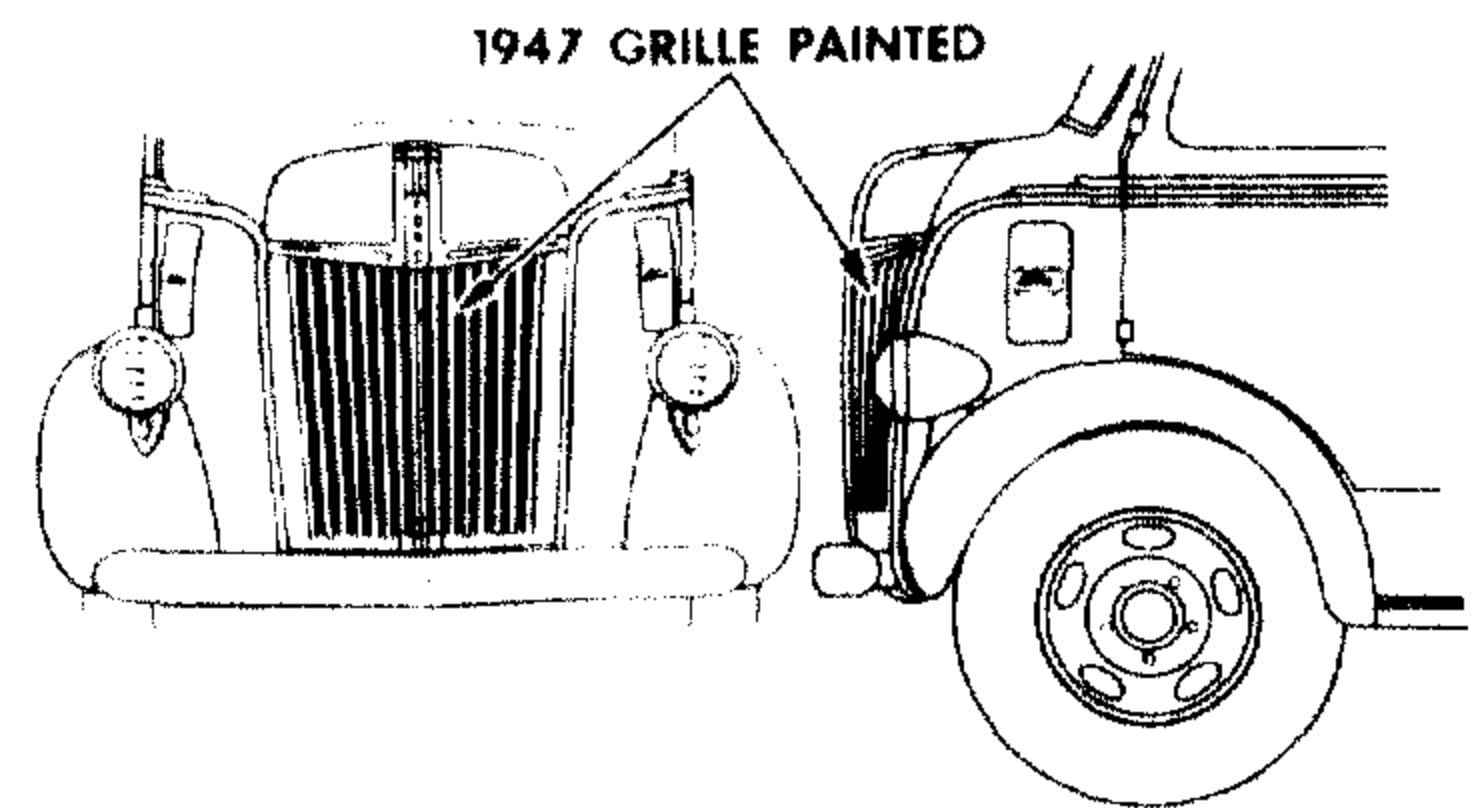
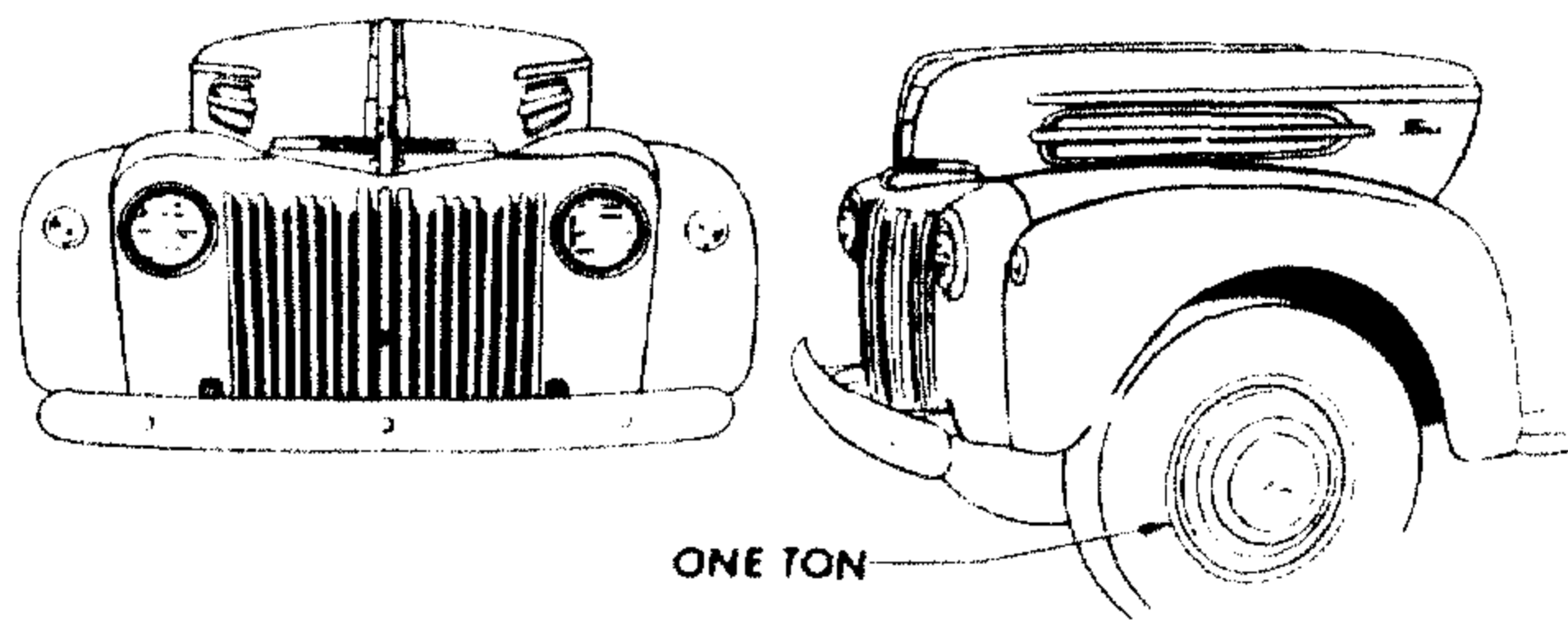

FORD 1 TON TRUCK

MODEL	ENGINE	HP.
79Y	8 cylinder.....	100
7GY	6 cylinder.....	90
7HY	6 cylinder.....	95

FORD CAB-OVER-ENGINE

MODEL	ENGINE	HP.	WHEELBASE
791W	8 cylinder	100.....	101"
79W	8 cylinder	100.....	134"
798W	8 cylinder	100.....	158"

BODY TYPE	NAME	BODY TYPE	NAME
80	Platform (114" Wheelbase)	81	Closed Cab (122", 134", 158" Wheelbase)
80	Platform (1 Ton) (122" Wheelbase)	81	Closed Cab (101", 134", 158" Cab-Over-Engine)
80	Platform (134" Regular and 101" Cab-Over-Engine)	82-A	Panel Delivery (114" Wheelbase)
80	Platform (134" Cab-Over-Engine)	82	Panel Delivery (1 Ton) (122" Wheelbase)
80	Platform (158" Wheelbase)	83	Pickup (114" Wheelbase)
81	Closed Cab (114" Wheelbase)	83	Express (1 Ton) (122" Wheelbase)

1948

FORD PASSENGER CAR MODELS

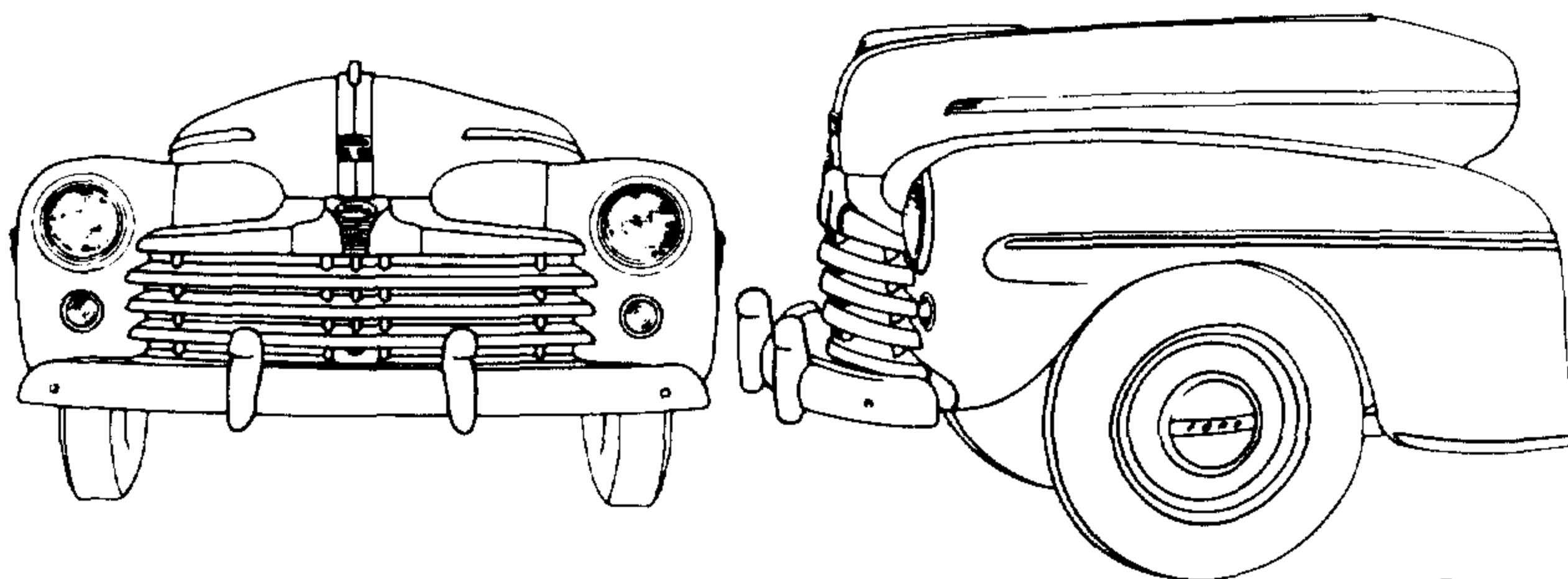

P.926

MODEL 89A FORD DELUXE OR SUPER DELUXE—100 HP. 8-Cylinder Engine

**MODEL 8HA FORD DELUXE OF SUPER DELUXE—95 HP. 6-Cylinder Engine
(114" Wheelbase)**

BODY TYPE	N A M E	BODY TYPE	N A M E
70-A	De Luxe Tudor Sedan	76	Super De Luxe Convertible Club Coupe
70-B	Super De Luxe Tudor Sedan	77-A	De Luxe (5-Window) Coupe
72-B	Super De Luxe Sedan Coupe	77-B	Super De Luxe (5-Window) Coupe
73-A	De Luxe Fordor Sedan	78	De Luxe Sedan Delivery
73-B	Super De Luxe Fordor Sedan	79-B	Super De Luxe Station Wagon

NOTE: The model prefix has been omitted from the various "Body Types." For the model or type required the model prefix should be added; for example, if a closed cab for a 90 HP. 8 cyl. engine 134" Wheelbase, 1942 truck is required the model number is 21T81. Should a closed cab for a 1942 6 cyl. 134" Wheelbase be required the model number is 2GT81, the 81 indicating any closed cab and 21T or 2GT the model number.

CHASSIS PARTS CATALOGUE

Alphabetical Index

Part Name	Basic Part No.	Part Name	Basic Part No.	Part Name	Basic Part No.
Back up lamp	18275	Bar (rear bumper)	17757	Bearing (u/joint)	7074
Baffle (brake grease)	2060	Bar (rear bumper center)	17963	Bearing (water pump)	8530
Baffle (brake grease)	2239	Bar (rear fender guard)	17785	Bearing (worm roller)	4615
Baffle (brake grease)	2240	Bar (rear spring clip)	5708-12	Bearing (worm thrust)	4696
Baffle (carb. air)	9437	Bar (rear track)	4264	Bellcrank (accelerator)	9724
Baffle (coupling shaft brg.)	4805	Bar (stabilizer brkts.)	3535	Bellcrank (accelerator)	9732
Baffle (float bowl)	9553	Bar (torsion)	5494	Bellcrank (shift rod support)	4279
Baffle (grille)	8365	Base (front axle bumper)	3022	Belt (fan)	8577
Baffle (radiator filler)	8067	Base (jack)	17088	Belt (fan)	8620
Baffle (trans. bearing oil)	7080	Base (radiator ornament)	8218	Belt (generator)	8620-21
Baffle (trans. main dr. gear)	7040	Base (rear axle bumper)	3022	Belt (water pump)	8577
Baffle (valve chamber cover)	6524	Base (regulator)	10545	Bezel (ignition switch)	11580
Baffle (valve chamber cover)	6540	Battery	10655	Bezel (inst. cluster)	10876
Bag (heater conn. parts)	18463	Battery cable	14195	Blade (windshield wiper)	17528
Bail (dist. cap cover)	12144	Battery cable	14300-01	Block (axle gear thrust)	4194
Bail (distributor coil)	12137	Battery Corrosion Arrestor	10682	Block (cylinder)	6010
Bail (dist. term. housing)	12109	Battery indicator	10844	Block (generator fuse)	14524
Bail (fuel pump strainer)	9387	Bearing assy (water pump)	8578	Blower (hot air heater)	18456
Bail (strg. light. switch)	3647	Bearing (clutch pilot)	7600	Body (brake booster)	2329
Bail & nut (sediment bulb)	9166	Bearing (clutch throw-out)	7580	Body (brake booster)	2366
Ball (carb. pump check)	9576	Bearing (clutch thrust)	7580	Body (brake bstr. cyl.)	2425
Ball (front radius rod)	3446	Bearing (connecting rod)	6211	Body (brake bstr. vac. cont.)	2327
Ball (gear shift lever)	7213	Bearing (countershaft gear)	7113	Body (brake bstr. valve)	2419
Ball (joint)-shock absorber	18118	Bearing (coupling shaft)	4812	Body (brake bstr. valve)	2441
Band (emergency brake)	2610	Bearing (crankshaft main)	6331-38	Body (brake bstr. valve)	6557
Band (generator cover)	10142	Bearing (drive shaft)	4635	Board (running)	16450-51
Band (hand brake & lining)	2548	Bearing (drive shaft center)	4658	Board (running)	16459
Band (oil filter mounting)	18664	Bearing (drive shaft roller)	4645	Board (running)	16468-69
Band (spare wheel lock)	18309	Bearing (driving pinion)	4625	Board (running)	16472-73
Band (spare whl. & tire lock)	18304	Bearing (driving pinion)	4221	Board (running)	16480-81
Band (spare whl. & tire lock)	18307-08	Bearing (fan spindle)	8626	Board (running)	16500-14
Band (starter front)	11125	Bearing (flywheel)	7600	Body (carburetor main)	9511
Band (wheel)	18303	Bearing (front wheel)	1201-16	Body (carb. throttle)	9506
Bar (bumper)-front	17757	Bearing (gen. armature)	10093	Body (carburetor throttle)	9518
Bar (bumper impact)	17757	Bearing (gen. end plate)	10094	Body (carburetor & plugs)	9507
Bar (bumper impact)-rear	17781	Bearing (gen. end plate)	10095	Body (dist. terminal)	12105
Bar (bumper outer)	17960	Bearing (generator shaft)	10094	Body (fuel pump)	9351-54
Bar (bumper)-rear	17906	Bearing (htr. blower shaft)	15125	Body (fuel pump)	9375
Bar (carburetor nozzle)	9920-21	Bearing (oil pump shaft)	6560	Body (ign. lock switch)	3704
Bar (carburetor nozzle)	9922-23	Bearing (pinion gear)	4621	Body (main)	9513
Bar (drive shaft guard)	4695	Bearing (power take off)	7271	Body (oil pump)	6603
Bar (fender apron support)	16156	Bearing (rear wheel)	1225	Body (oil pump)	6604
Bar (front bumper)	17752	Bearing (rear wheel)	1240-44	Body (parking lamp)	13778
Bar (front bumper back)	17760	Bearing (release)	7580	Body (radiator cap)	8109
Bar (front bumper cross)	17773	Bearing (speedometer gear)	17269	Body (rear lamp)	13408
Bar (front spring clip)	5458	Bearing (spindle bolt)	3123	Body (rear lamp)	13439
Bar (front spring shackle)	5468	Bearing (steering shift)	3551	Body (spare wheel lock)	18328
Bar (front track)	3530	Bearing (strg. worm roller)	3571	Body (throttle)	9514
Bar (fuel gauge)	9272	Bearing (trans. ball)	7065	Body (throttle)	9656
Bar (oil pressure gauge)	9274	Bearing (trans. countershaft)	7121	Body (upper)	9520
Bar (radiator grille)	8145	Bearing (trans. main dr. gear)	7025	Body (vac. cont. & check vlv.)	4071
Bar (radiator shell tie)	8232	Bearing (trans. pilot)	7120	Body (w/s washer pump)	17613
Bar (radiator support cross)	5071			Body & contact (light sw.)	11657



CHASSIS PARTS CATALOGUE

Alphabetical Index

Part Name	Basic Part No.	Part Name	Basic Part No.	Part Name	Basic Part No.
Body & plugs (carburetor)	9507	Bolt (oil filter return)	18661	Brace (front fender)	16088-89
Body & plugs (carburetor)	9512	Bolt (oil pump cover)	6607	Brace (front fender)	16094
Body & socket (rear lamp)	13407	Bolt (power take off lever)	7276	Brace (front fender apron)	16067
Body, arm & link (shock abs.)	18043-44	Bolt (radius rod)	2216	Brace (grille panel)	8363
Bolt (arm to bar)	17758	Bolt (radius rod)	2248	Brace (hood)	16934-35
Bolt (axle radius rod)	3033	Bolt (radius rod)	4769	Brace (hood catch)	8048
Bolt (axle radius rod)	3040	Bolt (rear spring perch)	4024	Brace (hood panel)	16863
Bolt (axle rod)	3032	Bolt (rear spring shackle)	5780	Brace (muffler inlet)	5274
Bolt (battery clamp)	5175	Bolt (rear track bar)	4268	Brace (rad. core to fender)	8046
Bolt (brake conn.)	2150	Bolt (regulator cover)	10624	Brace (radiator grille)	8214
Bolt (brake hsg. plate)	2056	Bolt (shift fork cover)	4273	Brace (radiator grille)	8232
Bolt (brake hsg. plate)	2216	Bolt (spare wheel bracket)	1447	Brace (radiator grille)	8272-73
Bolt (brake hsg. plate)	2248-9	Bolt (spare wheel carrier)	1408-58	Brace (radiator grille)	8426
Bolt (brake operating wedge)	2052	Bolt (spare wheel carrier)	1437	Brace (radiator to frame)	16863
Bolt (brake rocker arm)	2522	Bolt (spare wheel carrier)	1447	Brace (rear bumper ext.)	17832
Bolt (bumper arm)	17758	Bolt (spare wheel carr. arm)	1466	Brace (rear fender)	16341
Bolt (bumper bar center)	17765	Bolt (spare whl. carr. hinge)	1471	Brace (rear fender)	16446
Bolt (bumper bar end)	17834	Bolt (spare wheel clamp)	1454	Brace (running board)	16489
Bolt (bumper end)	17920	Bolt (spare wheel lock)	1440	Brace (spr. whl. carrier)	1408
Bolt (bumper guard)	17825	Bolt (spare wheel lock)	1495	Brace (steering col. brkt.)	3658
Bolt (bumper guard)	17908	Bolt (spindle)	3115-16	Brace (torsion bar bracket)	5510
Bolt (cap to coupling shaft)	4522	Bolt (spring tie)	5721	Brace & body bracket	5138-9
Bolt (coupling shaft)	4819	Bolt (starter frame)	11079	Bracket (accelerator)	9728
Bolt (coupling shaft hsg.)	4825	Bolt (starter through)	11091	Bracket (air cleaner)	9629
Bolt (coupling shaft hsg.)	4833	Bolt (steering gear housing)	4522	Bracket (antenna control)	18892
Bolt (coupling shaft supt.)	4522	Bolt (trans. bearing ret.)	5098	Bracket (apron support)	16078
Bolt (c/shaft bearing)	6345-46	Bolt (u/joint housing)	4522	Bracket (auxiliary spring)	5700
Bolt (c/shaft main brg. cap)	6344	Bolt (wheel hub front)	1107-8	Bracket (axle gear lever)	4172
Bolt (cylinder connection)	2276	Bolt (wheel hub rear)	1118-19	Bracket (back up lamp)	15517
Bolt (cyl. front cover)	12148	Bolt & collar (fender)	16336	Bracket (btry. tray to frame)	5170
Bolt (diff. carrier)	4272	Booster (brake)	2005	Bracket (battery support)	5153
Bolt (diff. gear case)	4216-7	Boot (brake cable)	2597	Bracket (body to frame)	5075
Bolt (dist. mounting)	12148	Boot (diaphragm conn. rod)	4096	Bracket (brake bstr.)-front	2031
Bolt (eng. radius rod)	6046	Boot (gear shift lever)	7242	Bracket (brake bstr.)-rear	2032
Bolt (eng. radius rod brkt.)	6042	Boot (master cylinder)	2180	Bracket (brake pedal)	2467
Bolt (engine rod)	6045	Boot (parking lamp socket)	13225	Bracket (brake pedal & shaft)	2473
Bolt (engine support)	6047	Boot (rear fender)	16349-50	Bracket (brake rocker arm)	2520
Bolt (front spring tie)	5345	Boot (ride stab. swivel)	3042-43	Bracket (brake rod spring)	2504
Bolt (gear shift housing)	12148	Boot (wheel cylinder)	2206-07	Bracket (brake shaft)	2458
Bolt (gear shift lever)	7216	Boss (oil filter to oil pan)	6692	Bracket (brake shaft)	2478
Bolt (generator frame)	10166	Boss (oil level indicator)	6751	Bracket (cable support)	4120
Bolt (gen. frame thru)	10120	Bowl (carb.)	9512	Bracket (carb. mounting)	9626
Bolt (gen. pulley)	10143	Bowl (fuel pump)	9355	Bracket (carb. throttle)	9791
Bolt (hand brake)	2799	Bowl (sediment bulb)	9161-62	Bracket (check valve)	4077
Bolt (hand brake lever)	4522	Box (terminal)	14560	Bracket (choke & throttle)	9796
Bolt (headlamp bracket)	1447	Brace (air cleaner)	9629	Bracket (clutch shaft)	7507
Bolt (headlamp swivel)	13020	Brace (air cleaner)	9663	Bracket (clutch & brk. shaft)	2467
Bolt (headlamp tie rod)	13119	Brace (arm cross)	17783	Bracket (cowl lamp)	13322
Bolt (horn brkt. mtg.)	13834	Brace (battery support)	5168	Bracket (cross member)	5194
Bolt (inter. shift rod supt.)	4075	Brace (bumper end guard)	17862	Bracket (defroster pipe)	18547
Bolt (manifold)	9427	Brace (cross member)	5068	Bracket (diaphragm support)	4095
Bolt (master cyl. fitting)	2077	Brace (fender apron support)	16146	Bracket (dist. contact point)	12160
Bolt (muffler bracket)	4522	Brace (frame cross member)	5048	Bracket (dist. contact point)	12196-97

CHASSIS PARTS CATALOGUE

Alphabetical Index

Part Name	Basic Part No.	Part Name	Basic Part No.	Part Name	Basic Part No.
Bracket (dual high shifter)	4902	Bracket (hood rod guide)	16651	Bracket (rear view mirror)	17741-42
Bracket (electric air horn)	13828	Bracket (hood side)	16836	Bracket (reflector)	13382
Bracket (eng. front support)	6037-38	Bracket (hood side support)	16804-05	Bracket (road lamp)	15206
Bracket (eng. radius rod)	6040	Bracket (hood support)	16794-95	Bracket (road lamp)	15209
Bracket (eng. stabilizer)	6808	Bracket (horn)	13830-31	Bracket (roadlamp)	18160
Bracket (engine support)	5086-87	Bracket (hot air heater)	15120	Bracket (running board)	5130
Bracket (fan mounting)	8632	Bracket (hot water heater)	15152	Bracket (running board)	5145-A2
Bracket (fender guard bar)	17798	Bracket (hot water heater)	18597	Bracket (running board)	16457
Bracket (fender guard bar)	17845	Bracket (ign. coil)	12257	Bracket (running board)	16462
Bracket (fender shield)	18977-79	Bracket (instrument lamp)	13720	Bracket (running board)	16470-71
Bracket (fender shield)	18983-89	Bracket (lamp control)	13469	Bracket (running board)	16489-94
Bracket (frame)	5076-8	Bracket (license & guard)	17768	Bracket (running board)	16575
Bracket (frame corner)	5031	Bracket (master cylinder)	2467	Bracket (shift rod)	4173
Bracket (frame eng. support)	5059	Bracket (mirror)	17697	Bracket (shock absorber)	18183-84
Bracket (frame side member)	5048-49	Bracket (mirror)	17745	Bracket (spare wheel carrier)	1415-16
Bracket (frame to body)	5078	Bracket (motor support mtg.)	17485	Bracket (spare wheel carrier)	1433
Bracket (front brake hose)	2082	Bracket (muffler)	5256-8	Bracket (spare wheel carrier)	1453
Bracket (front fender)	16025	Bracket (muffler pipe)	5259	Bracket (spare wheel mounting)	1434
Bracket (front fender)	16032-33	Bracket (muffler pipe)	5260-61	Bracket (speedometer cable)	4083
Bracket (front fender)	16047-48	Bracket (oil filter mounting)	18665	Bracket (speedometer cable)	17263
Bracket (front fender)	16088-94	Bracket (pedal rod arm)	2520	Bracket (spotlight)	15323
Bracket (front fender apron)	16120-23	Bracket (radiator)	8341	Bracket (spotlight)	18573-74
Bracket (front license)	5034-8	Bracket (rad. air defl.)	8221	Bracket (spring pivot)	5785
Bracket (front spring RH)	5338	Bracket (rad. core to hood)	8046-47	Bracket (stabilizer)	3554
Bracket (front spring LH)	5339	Bracket (radiator grille)	8342	Bracket (stabilizer bar)	5485
Bracket (front spring RH)	5340	Bracket (radiator grille)	8458	Bracket (starting motor)	11140
Bracket (front spring LH)	5341	Bracket (radiator grille)	16556	Bracket (steering column)	3523
Bracket (fuel tank)	9046	Bracket (rad. support panel)	16142-43	Bracket (steering column)	3678
Bracket (gear shift tube)	7318	Bracket (rad. support rod)	8140	Bracket (steering gear)	5102
Bracket (generator)	10151	Bracket (rad. & eng. supt.)	5057-58	Bracket (strg. gear frame)	5104
Bracket (gen. to cyl. block)	6129	Bracket (rad. on frame)	5073-74	Bracket (strg. gear switch)	3569
Bracket (hand brake)	2845	Bracket (rad. to frame)	5069-70	Bracket (stop light switch)	13481
Bracket (hand brake cable)	2808	Bracket (rear brake hose)	2073	Bracket (tail light)	13459
Bracket (hand brake conduit)	2830	Bracket (rear bumper)	17928	Bracket (tire & fire unit)	17942
Bracket (hand brake equal.)	2770	Bracket (rear fender)	16180-82	Bracket (top control cable)	16930
Bracket (hand brake lever)	2795	Bracket (rear fender)	16240	Bracket (torsion bar)	5486-87
Bracket (hand brake lever)	2848	Bracket (rear fender)	16339	Bracket (tray to fndr. apron)	5168
Bracket (hand brake screw)	2654	Bracket (rear fender)	16340	Bracket (valve chamber pipe)	6788
Bracket (headlamp)	13125	Bracket (rear fender)	16341	Bracket (w/s washer mounting)	17614
Bracket (headlamp)	13126	Bracket (rear fender)	16445	Bracket (w/s wings)	18254
Bracket (heater control)	18449	Bracket (rear lamp)	13406	Bracket (w/s wiper hose)	17594
Bracket (heater support)	18479	Bracket (rear lamp)	13432	Bracket (w/s wiper vac. tank)	17645-47
Bracket (hood catch)	8050	Bracket (rear lamp)	13468	Bracket & clamp (mirror)	17681-82
Bracket (hood catch)	8098	Bracket (rear lamp)	13470-73	Bracket & strap (w/s washer)	17606
Bracket (hood catch)	16628-29	Bracket (rear lamp socket)	13423	Bracket & stud (shock abs.)	18164-65
Bracket (hood catch cable)	16930	Bracket (rear lamp & license)	13469	Brake booster cyl. kit	2337
Bracket (hood catch lever)	16639	Bracket (rear license)	13406	Brake booster repair kit	2309
Bracket (hood catch rod)	16627	Bracket (rear spring shackle)	5775	Brake cylinder kit	2128
Bracket (hood catch rod)	16638	Bracket (rear spring shackle)	5785	Brake cylinder kit	2221
Bracket (hood control cable)	16930	Bracket (rear track bar)	4266-67	Brake drum assy (front)	1102-05
Bracket (hood hinge)	8220	Bracket (spring shackle)	5335-37	Brake drum assy (rear)	1113-15
Bracket (hood hinge)	8226	Bracket (rear view mirror)	17698	Brake kit	18370
Bracket (hood hinge)	16726	Bracket (rear view mirror)	17708	Brake lining kit	2007

CHASSIS PARTS CATALOGUE

Alphabetical Index

Part Name	Basic Part No.	Part Name	Basic Part No.	Part Name	Basic Part No.
Cable (carburetor choke)	9700	Cap (radiator)	8100	Clamp (air cleaner)	9613
Cable (emergency brake)	2275	Cap (radiator grille)	8118	Clamp (air cleaner)	9628
Cable (generator to regulator)	14420	Cap (rear axle hsg.)	4190	Clamp (air cleaner bracket)	9654
Cable (heater valve control)	18496	Cap (spare wheel lock)	18310	Clamp (air cleaner hose)	9653
Cable (hood catch control)	16919	Cap (spindle grease ret.)	3333	Clamp (arm to bar)	17756
Cable (shift)	4138	Cap (spring seat)	5796-7	Clamp (arm to bar)	17758
Cable (solenoid to pump)	14506	Cap (starter end plate)	11053	Clamp (asbestos hose-heater)	18499
Cable (starter motor to relay)	14431	Cap (steering housing)	3589	Clamp (bar center)	17762
Cable (throttle)	9775	Cap (universal joint housing)	4513	Clamp (bar center)	17765
Cable & conduit (frt.brake)	2494	Cap (universal joint housing)	4520	Clamp (battery)	5163
Cable & conduit (hand brake)	2853	Cap (univ.joint knuckle dust)	7077	Clamp (battery)	5165
Cable & conduit (rear brake)	2498	Cap (water pump)	8514	Clamp (brake booster body)	2350
Cable, conduit & end (speed.)	4085	Cap (wheel hub)	1130-31	Clamp (brake bstr. vac. hose)	2344
Cam (brake shoe pin)	2028-9	Carburetor assy.	9510	Clamp (brake cable conduit)	2505
Cam (distributor)	12210	Carburetor-less choke lever	9509	Clamp (brake conduit)	2502
Cam (dist.-& weights)	12176	Carburetor Chart- Page 433		Clamp (brake plate conduit)	2102
Cam (hand brake band)	2632	Carburetor repair kit	9590	Clamp (breather hose)	2342
Cam (rear brake)	2230	Carrier (battery)	10732	Clamp (bumper arm)	17830
Cam & shaft (high & inter.)	7280	Carrier (dual high planet).	4851	Clamp (carb. nozzle bar)	9928
Cam & shaft (low & reverse)	7282	Carrier (spare wheel)	1379	Clamp (chain housing)	17546
Camshaft	6250	Carrier (spare wheel)	1380	Clamp (choke control)	9791
Camshaft Bearing Chart- Page 254		Carrier (spare wheel)	1429	Clamp (cyl. block drain)	8040
Camshaft (rear brake)	2231	Carrier (spare wheel)	1433	Clamp (distributor cap)	12144
Camshaft gear	6256	Carrier (tire)	1433	Clamp (emergency brake rod)	13512
Camshaft Gear Chart-Page 251		Carrier & bearing cap (diff.)	4141	Clamp (front fender spacer)	16088
Camshaft & gear	6251	Cartridge (oil filter)	18662	Clamp (front spring)	5330
Cap (brake adjusting brkt.)	2043-4	Case (battery)	10660	Clamp (fuel tank filler)	8287
Cap (brake booster breather)	2363	Case (differential)	4119	Clamp (headlamp)	13083
Cap (brake bstr. vac. valve)	2326	Case (diff. gear)	4205-6	Clamp (heat indicator cable)	10882
Cap (choke lever shaft)	9645	Case (diff. gear support)	4027	Clamp (heater connection)	18572
Cap (clock)	15036	Case (fuel & oil gauge)	9271	Clamp (heater muffler pipe)	18507
Cap (condenser)	12312	Case (gear support)	4127	Clamp (hold down)	5171
Cap (c/shaft rear bearing)	6327	Case (headlamp)	13026	Clamp (hood control cable)	16877
Cap (crankshaft bearing)	6330	Case (head lamp & support)	13010	Clamp (hood lock cable)	16907
Cap (crankshaft rear bearing)	6325	Case (hot water heater)	15149	Clamp (hot air heater shroud)	18553
Cap (distributor)	12105	Case (ignition lock switch)	3712	Clamp (hot water heater)	18481
Cap (dist. primary term.)	12249	Case (temp. & ammeter gauge)	10887	Clamp (manifold)	9443
Cap (dist. term. body)	12115	Case (transmission)	7005-6	Clamp (muffler)	5251-52
Cap (distributor vent)	12147	Case & support (headlamp)	13009	Clamp (muffler cross pipe)	5253
Cap (drag link grease ret.)	3333	Casing (speedometer shaft)	17261	Clamp (muffler inlet pipe)	5270
Cap (front hub dust)	1190	Casing & shaft (speedometer)	17260	Clamp (muffler pipe)	5256-61
Cap (front hub inner)	1139	Catch (hood)	16750	Clamp (muffler tail pipe)	5265
Cap (front radius rod ball)	3440	Catch (hood auxiliary)	16892	Clamp (oil filter hose)	18639
Cap (fuel tank)	9030	Catch (hood top latch)	16626-27	Clamp (oil filter inlet hose)	18692-93
Cap (fuel tank locking)	18416	Center & End Bumper Guard	18383	Clamp (oil filter inlet tube)	18690
Cap (gear shift lever)	7220	Channel (spare wheel carrier)	1443	Clamp (oil filter return hose)	18643
Cap (gear shift tube brkt.)	7319	Check (hood catch latch)	16718	Clamp (oil filter return tube)	18695
Cap (gen. end)	10091	Check (pump)	9573	Clamp (oil gauge wire)	14588
Cap (gen. end plate)	10118	Check (vane)	9543	Clamp (oil pump spring)	6618
Cap (idle needle spring)	9579	Choke Control Rod Chart- Page 446		Clamp (parking lamp wire)	14588
Cap (master cylinder filler)	2162	Cigar Lighter	7004600	Clamp (radiator hose)	8261
Cap (oil filler)	6766			Clamp (radiator hose)	8287
				Clamp (rear spring)	5703-24

Alphabetical Index

Part Name	Basic Part No.	Part Name	Basic Part No.	Part Name	Basic Part No.
Clamp (ride stabilizer)	3555	Clip (fast idle rod)	9565	Clip (speedometer cable)	2244
Clamp (ride stabilizer boot)	3055-56	Clip (foot switch)	14585	Clip (speedometer cable)	14565
Clamp (road lamp bracket)	15211	Clip (foot switch wiring)	14197	Clip (speedometer cable)	14577
Clamp (road lamp bracket)	15226	Clip (front fender)	16046	Clip (speedometer cable)	14585
Clamp (spare tire moulding)	1359	Clip (front license)	13145	Clip (speedometer cable)	17264
Clamp (spare wheel)	1446	Clip (fuel gauge air line)	9279	Clip (speedometer cable)	17278-79
Clamp (speedometer conduit)	4044	Clip (fuel gauge indicator)	14194	Clip (stop light switch)	14565
Clamp (spindle conn. rod)	3287	Clip (fuel line)	2244	Clip (stop light switch)	14586
Clamp (steering column)	3507	Clip (fuel line)	14565-85	Clip (starter drive spring)	11383
Clamp (stop light switch)	13511	Clip (fuel line to frame)	2081	Clip (term. box to generator)	14577
Clamp (stop light sw. chain)	13512	Clip (fuel tank gauge)	14586	Clip (throttle cont. rod)	9776
Clamp (throttle control rod)	9797	Clip (fuse block)	14586	Clip (vacuum tube)	14577
Clamp - "U"	5251	Clip (fuse block)	14588	Clip (wheel hub cap)	1034
Clamp & chain (brake spring)	13511	Clip (generator wiring)	14197	Clip (window lift wire)	14577
Clamp & sleeve (coil)	14570	Clip (glove compartment clock)	14586	Clip (window lift wiring)	14588
Clamp (wiring)	14570-72	Clip (hand brake cable)	2279	Clip (window solenoid)	14586
Cleaner (carburetor air)	9600	Clip (hand brake cable)	2814	Clip (wiper tube&speed cable)	14577
Cleaner (cooling system)	18442	Clip (hand brake cable)	14565	Clip (wire)	14464
Clevis (brake cable)	2460	Clip (headlamp wire)	14585	Clip (wire)	14588
Clevis (brake cable)	2466	Clip (headlamp wire)	14586	Clip (wire)	14595
Clevis (brake pedal)	2466	Clip (headlamp wire)	14588	Clip (wiring)	14564
Clevis (brake valve oper.rod)	2461	Clip (headlamp wire)	14598	Clip (wiring)	14577
Clevis (clutch pedal)	7532	Clip (headlamp wiring)	14197	Clip (wiring starter switch)	14585
Clevis (emer.brake equalizer)	2121	Clip (headlamp wiring)	14565	Clip (wiring to side member)	14585
Clevis (gear shift rod)	7354	Clip (hd. & prk. lp. wire)	14199	Clip (wiring to radiator)	14565
Clevis (hand brake cable)	2484	Clip (hood)	16750	Clocks	15005
Clip (ammeter wire)	14585	Clip (hood)	16779	Clutch Chart- Page 338	
Clip (brake bstr. vac. tube)	2279	Clip (hood latch cable)	14598	Clutch disc	7550
Clip (brake pipe)	2081	Clip (hood latch cable)	16828-29	Clutch Disc Repl. Chart- Page 344	
Clip (brake pipe)	2244	Clip (hood lock cable)	16931	Clutch (dual high stationary)	4842
Clip (brake pipe)	2281	Clip (hood lock fender flange)	16899	Clutch pressure plate	7563
Clip (brake retracting spring)	2442	Clip (horn wiring)	2081	Cock (radiator drain)	8115
Clip (brake tube)	14586	Clip (instrument panel)	14585	Coil (cutout unit shunt)	10514-17
Clip (carb. choke cont. rod)	9610	Clip (inst. panel lamp)	14595	Coil (distributor)	12024
Clip (choke)	9761	Clip (inst. panel lamp wire)	14585	Coil (dist.-less condenser)	12036
Clip (choke control)	16828	Clip (latch rod spring)	16873	Coil (generator field)	10175
Clip (choke & throttle rod)	9718	Clip (license lamp)	14586	Coil (ignition)	12000
Clip (choke to throttle rod)	9798	Clip (license lamp wiring)	14577	Coil (ignition)	12029
Clip (cigar lighter wire)	14586	Clip (light switch wiring)	14565	Coil (ignition)	12029
Clip (cowl wiring)	14197	Clip (lighting switch wiring)	14577	Coil (starter field)	11080-82
Clip (cowl wiring)	14577-85	Clip (lighting switch wiring)	14585	Coil (starter field)	11083-85
Clip (cowl wiring)	14588-92	Clip (oil & temp. gauge)	14197	Collar (brake bstr. push rod)	2440
Clip (cowl wiring)	14592	Clip (oil filter tube)	6738	Collar (carb. throttle lever)	9614
Clip (cowl wiring)	14598	Clip (parking lamp)	2224	Collar (clutch shaft)	7516
Clip (cowl wiring to dash)	14199	Clip (prk. lamp lens ret.)	13214	Collar (clutch & brake pedal)	7507
Clip (cross over conduit)	12288	Clip (rear lamp lens)	13439	Collar (dist. shaft)	12195
Clip (dimmer switch wire)	14565	Clip (rear lamp wire)	14565	Collar (gen. bearing adjusting)	10135
Clip (distributor vac. tube)	2244	Clip (rear lamp wire)	14577	Collar (rear brake camshaft)	2244
Clip (dome lamp switch)	14588	Clip (rear lamp wire)	14585-86	Collar (w/s wiper pivot shaft)	17579
Clip (dome lamp to switch)	14565	Clip (rear lamp wire)	14588	Commutator (gen. armature)	10025
Clip (dome light switch)	14586	Clip (rear lamp wire)	14592	Condenser (distributor)	12300
Clip (dome light wire)	14281	Clip (rear spring)	5701-05	Condenser (horn)	13814
Clip (emer.brake conduit)	2279	Clip (rear wdo. lift wiring)	14588	Condenser (ign. coil)	12300

CHASSIS PARTS CATALOGUE

Alphabetical Index

Part Name	Basic Part No.	Part Name	Basic Part No.	Part Name	Basic Part No.
Conductor (dist. breaker)	12215	Connector(wiper & dist.vacuum)	17595	Cover (sediment bulb)	9165
Conduit (dome lamp wire)	14543	Connector (wire)	14564	Cover (shift fork)	4052
Conduit (dome lamp to switch)	14541	Connector (wire & sleeve)	14487	Cover (spare wheel)	18302
Conduit (headlamp wire)	14578	Contact (horn)	13836	Cover (spare wheel lock)	18313
Conduit (headlamp wire)	14597	Contact (horn lower)	13864	Cover (speedometer)	17259
Conduit (hd. lp. & horn wire)	14579	Contact (spotlight switch)	18579	Cover (spindle con. rod dust)	3333
Conduit (horn wire)	14582	Contact (starter switch)	11458	Cover (spring)	5507
Conduit (ignition cable)	12110	Control (carburetor choke)	9700	Cover (spring canvas)	5509
Conduit (license lamp wire)	14597	Control (defroster valve)	18548	Cover (starter pinion)	6677
Conduit (rear lamp wire)	14597	Control (starter hand switch)	11475	Cover (starter switch)	11481
Conduit (spark plug wires)	12112	Control (throttle)	9775	Cover (steering gear hsg.)	3580
Cone (drive shift rear brg.)	4672	Control (vacuum w/s wiper)	17534	Cover (steering gear hsg.)	3584
Cone & roller (differential)	4242	Control (w/s washer)	17604	Cover (terminal box)	14561
Cone & roller(driving pinion)	4221	Control (w/s wiper less knob)	17470	Cover (trans. power take off)	7165
Cone & roller(frt.wheel brg.)	1201	Control & check valve (vac.)	4076	Cover (valve chamber)	6520
Cone & roller(frt.wheel brg.)	1216	Core (hot water heater)	18476	Cover (valve chamber)	6756
Cone & rollers(pinion brg.)	4621	Core (hot water heater)	15133	Cover (water pump)	8508
Cone & roller(rear wheel brg.)	1240	Cork (univ.joint hsg. cap)	4516	Cover (water pump hole)	8528
Cone & roller(rear wheel brg.)	1244	Cotter pin (pump link)	9580	Cover (wheel cylinder)	2055
Connecting rod	6200	Countershaft (transmission)	7111	Cover (w/s washer jar)	17616
Connecting Rod Bearing Chart- Page 248		Counterweight (exhaust valve)	9458	Cover (wiring on dash)	14600
Connection (battery ground)	14301	Coupling (carb. control rod)	9702	Cover & bail (gen.)	10129
Connection (brake cyl. inlet)	2080	Coupling (drive shaft)	4684	Crank (starting)	17036
Connection (brake cyl.inlet)	2277	Coupling(radiator drain cook)	8077	Crankshaft	6303
Connection (clutch bearing)	7557	Cover(accelerator pedal hub)	9777	Crankshaft gear	6306
Connection (cyl. head outlet)	8250	Cover (air cleaner)	4079	Cross member (frame)	5012
Connection (cyl.water inlet)	6087	Cover (axle housing)	4033	Cross member (frame)	5019-20
Connection (cyl. water inlet)	8275	Cover (brake brkt. hole)	2473	Cross member (frame)	5025-30
Connection (engine ground)	14303	Cover (carburetor air)	9602	Cross member (frame)	5035-52
Connection (fuel line)	9288	Cover (clutch housing)	7518	Cross member (frame)	5096
Connection (hand brake lever)	2637	Cover (crank hole)	8424	Cross member (frame)	5134
Connection (oil filter tube)	18670	Cover (cylinder front)	6019	Cross member - No.4	5032
Connection (oil pump)	6633	Cover (cylinder timing gear)	6017	Cup (accelerator shaft brkt.)	9794
Connection (w/s washer tee)	17615	Cover (dist. breaker dust)	12276	Cup (brake booster piston)	2399
Connection (w/s wiper tube)	17540	Cover (float bowl)	9559	Cup (brake booster piston)	2408
Connection(w/s wiper tube "T")	17489	Cover (front spring)	5305-07	Cup (brake shoe spring)	2071
Connector (brake bstr. cyl.)	2420	Cover (fuel gauge)	9326	Cup (clutch release brg.)	7558
Connector (brake line)	2074	Cover (fuel gauge tank unit)	9284	Cup (differential bearing)	4222
Connector (clock)	15027	Cover (fuel pump)	9355	Cup (diff. bearing)	4241
Connector (cutout to gen.)	10550	Cover (gen. oil wick)	10146	Cup (drive shaft bearing)	4672
Connector (dist. to sp. plug)	12275	Cover (governor opening)	18223	Cup (driving pinion bearing)	4616
Connector (front brake pipe)	2075	Cover (grille)	8110	Cup (frt. wheel brg.-inner)	1202
Connector (hand brake lever)	2853	Cover (grille moulding joint)	8181	Cup (frt. wheel brg.-outer)	1217
Connector (oil filter tube)	18672	Cover (light switch lower)	11655	Cup (gear shift bracket)	7314
Connector (rear lamp wire)	14587	Cover (oil filter)	18687	Cup (gen. oil)	10083
Connector(release brg.grease)	7557	Cover (oil pan)	6366	Cup (master cylinder)	2173
Connector (roadlamp wire)	14487	Cover (oil pump drive)	6664	Cup (oil)	9658
Connector (stoplight switch)	14487	Cover (oil pump screen)	6611	Cup (rear wheel brg.-outer)	1239
Connector (vacuum tank)	17545	Cover (oil pump and tube)	6615	Cup (rear wheel grease ret.)	1176
Connector (w/s wiper adapter)	17644	Cover (parking lamps)	13216	Cup (rear wheel inner brg.)	1243
Connector (windshield wiper)	14471	Cover (rad. shell mldg.)	8268-69	Cup (steering gear bearing)	3552-53
Connector (w/s wiper tube)	17597	Cover (rear spring)	5505	Cup(transfer shaft roller brg.)	7168-69
		Cover (regulator)	10560	Cup (wheel brake cyl.)	2201-2

Alphabetical Index

Part Name	Basic Part No.	Part Name	Basic Part No.	Part Name	Basic Part No.
Gasket (dist. breaker plate)	12173	Gasket (oil pan drain plug)	12410	Gasket set (carburetor)	9502
Gasket (distributor cap)	12108	Gasket (oil pump cover)	6619	Gasket set (distributor)	12104
Gasket (distributor coil)	12140	Gasket (oil pump drive cover)	6659	Gasket set (engine oil pan)	6781
Gasket (dist. term. hsg.)	12114	Gasket (oil pump screen cover)	6626	Gasket set (engine overhaul)	6008
Gasket (drive pinion)	4507	Gasket (oil return pipe)	6648	Gasket set (manifold)	9433
Gasket (drive pinion brg.)	4662	Gasket (parking lamp body)	13209	Gasket set (oil pan)	18512
Gasket (dual high front hsg)	12410	Gasket (parking lamp lens)	13085	Gasket set (trans. & u/joint)	7153
Gasket (end plate bearing)	10086	Gasket (parking lamp lens)	13211	Gasket set (u/joint)	7038
Gasket (eng. oil filter mtg.)	6838	Gasket (parking lamp lens)	13785	Gasket set (valve job)	6079
Gasket (fan front)	8638	Gasket (poppet valve body)	2382	Gas tank	9002
Gasket (fan rear)	8646	Gasket (power take off cover)	7166	Gate (reverse shifter shaft)	7232
Gasket (float bowl cover)	9561	Gasket (pump valve screw)	9608	Gauge (fuel)-instr. panel unit	9280
Gasket (fly wheel housing)	6396	Gasket (radiator cap)	8111	Gauge (fuel tank unit)	9275
Gasket (fuel gauge)	9307	Gasket (radiator cap)	8138	Gauge (oil)-engine unit	9278
Gasket (fuel gauge frame)	9321	Gasket (rear axle housing)	4035	Gauge (oil pressure)	9273
Gasket (fuel gauge glass)	9324	Gasket (rear axle housing)	4036	Gauge (temp.)	10883
Gasket (fuel pump)	18673	Gasket (rear axle hsg. cap)	4191	Gauge & hose (tire pump)	17052
Gasket (fuel pump cover)	9364	Gasket (rear axle shaft)	1144	Gear assy (steering)	3503
Gasket (fuel pump diaphragm)	9394	Gasket (rear lamp door)	13460	Gear (camshaft)	6256
Gasket (fuel pump drain plug)	9388	Gasket (rear lamp door)-outer	13461	Gear (coupling shaft)	4811
Gasket (fuel pump valve)	9363	Gasket (rear lamp white lens)	13447	Gear (crankshaft)	6306
Gasket (fuel pump valve)	9367	Gasket (rear wheel cyl.)	2149	Gear (diff. & driving pinion)	4209
Gasket (fuel pump to adapter)	9417	Gasket (rear wheel hub)	1183	Gear (drive)	4210
Gasket (fuel pump to cyl.)	9374	Gasket (regulator cover)	10623	Gear (driving)	4203
Gasket (fuel tank cap)	9035	Gasket (road lamp lens)	15216	Gear (driving & gear case)	4207
Gasket (fuel tank unit)	9276	Gasket (road lamp lens)	18566	Gear (flywheel ring)	6384
Gasket (gear shift housing)	7223	Gasket (sediment bulb)	9174	Gear (oil pump drive)	6254
Gasket (gear shift housing cap)	7207	Gasket (sediment bulb bowl)	9160	Gear (oil pump drive idler)	6655
Gasket (generator end cap)	10119	Gasket (shift fork cover)	4073	Gear (oil pump driven)	6610
Gasket (governor to cylinder)	6022	Gasket (spark plug)	12410	Gear (oil pump driving)	6614
Gasket (headlamp)	13044	Gasket (speedometer drive cap)	17275	Gear (oil pump shaft)	6652
Gasket (headlamp lens)	13066	Gasket (speed. & instr. glass)	10861	Gear (planetary)	4229
Gasket (headlamp ring)	13039	Gasket (steering gear housing)	3581	Gear (power take off)	4870
Gasket (horn diaphragm)	13817	Gasket (steering gear hsg.)	3592	Gear (power take off)	7254
Gasket (hot water heater)	18570	Gasket (steer. gear hsg. cap)	3594	Gear (sliding clutch)	4055
Gasket (instrument bezel)	10856	Gasket (steering housing cap)	3593-95	Gear (speedometer)-and cap	17270
Gasket (license plate lamp)	13568-69	Gasket (thermostat)	8590	Gear (speedometer driven)	17271
Gasket (license plate lamp)	13573	Gasket (timing gear cover)	6018	Gear (speedometer driving)	17285
Gasket (manifold)	9448	Gasket (torque tube housing)	4507	Gear (steering assy)	3504
Gasket (manifold to cylinder)	9441-42	Gasket (trans. bearing retainer)	7051	Gear (rear axle shaft)	4236
Gasket (master cyl. filler cap)	2167	Gasket (trans. bearing retainer)	7086	Gear (rear axle shaft)	4239
Gasket (muffler pipe manifold)	9450	Gasket (univ. joint housing cap)	4509	Gear (trans. countershaft)	7112
Gasket (needle valve seat)	9569	Gasket (univ. joint housing cap)	4515	Gear (trans. countershaft)	7113
Gasket (nozzle air bleed plug)	9925	Gasket (upper body to bowl)	9592	Gear (trans. high & inter.)	7102
Gasket (oil filter)	18689	Gasket (valve chamber cover)	6521	Gear (trans. high & third)	7101
Gasket (intake & exh. manifold)	9435	Gasket (ventilator tube)	6769	Gear (trans. intermediate)	7102
Gasket (oil filter bolt)	18675	Gasket (water pump)	8513	Gear (trans. intermediate)	7103
Gasket (oil filter cover)	18688	Gasket (water pump body)	8541-42	Gear (trans. low & reverse)	7100
Gasket (oil filter pipe boss)	6691	Gasket (water pump hole cover)	8529	Gear (trans. main drive)	7017
Gasket (oil level indicator)	6761	Gasket (water pump housing)	8507	Gear (trans. reverse idler)	7141
Gasket (oil level ind. boss)	6753	Gasket (water pump housing)	8543	Gear & bushing (dual high)	4862
Gasket (oil pan)	6710-11	Gasket (w/s wiper cont. stem)	17550	Generator	10001
Gasket (oil pan drain plug)	6734	Gasket (w/s wiper silencer)	2149	Generator assy	10000



CHASSIS PARTS CATALOGUE

Alphabetical Index

Part Name	Basic Part No.	Part Name	Basic Part No.	Part Name	Basic Part No.
Generator belt	8620-21	Grommet (fuel tank)	9066	Guard (rear fender)	17784
Generator brush	10069-70	Grommet (fuel tank)	9080	Guard (rear wheel)	16412
Generator brush set	10043	Grommet (fuel tank)	9081	Guard (rear wheel splash)	16412-13
Generator charge indicator	10850	Grommet (fuel tank)	9084	Guard (spare wheel)	17806
Generator Chart- Page 460		Grommet (fuel tank)	9085	Guard & brkt. (front license)	17768
Generator end plate	10050	Grommet (fuel tank filler)	16388	Guide (crank)	8210
Generator end plate	10129	Grommet (hand brake & pedal)	14607	Guide (emerg. cable stab.)	2271
Generator Regulator Chart- Page 482		Grommet (headlamp wire cond.)	14567	Guide (hood lock spring)	16927
Generator Repl. Chart- Page 458		Grommet (headlamp wiring)	13091	Guide (lever)	7320
		Grommet (hood catch cable)	14605	Guide (metering pin)	9527
				Guide (shift rod)	4057
				Guide (starting crank)	17769
Glass (draft deflector)	18294	Grommet (horn proj. support)	13822	Guide (vacuum cont. plunger)	4051
Glass (headlamp)	13060	Grommet (horn wire)	16386	Guide (valve)	6510-11
Glass (instrument)	10865	Grommet (horn wire conduit)	14567	Guide (water pump spring)	8573
Glass (instrument)	10880	Grommet (horn to fender)	13912	Gun (grease)	17125
Glass (mirror)	17704	Grommet (ignition cable)	12297	Gun (spray)	17051
Glass (tail lamp)	13450	Grommet (ignition wire)	14587	Gusset (cross to side member)	5049
Glass (windshield wing)	18258	Grommet (lugg. compt. wiring)	14567	Gusset (frame cross member)	5031-32
Glass (windshield wings)	18294	Grommet (oil filter)	18674	Gusset (frame cross member)	5051
Governor	18204	Grommet (rad. filler neck)	8071	Gusset (frame cross member)	5074
Governor kit (engine)	18204	Grommet (rad. filler pipe)	8373	Gusset (frame cross member)	5097
				Gusset (frame cross member)	5123
Governor (windshield wiper)	17475	Grommet (rear lamp wire)	14567	Gusset (frame cross member)	5146
Grease cup (clutch rel. brg.)	7558	Grommet (rear lamp wire)	16386		
Grease retainer (drag link)	3332	Grommet (rotary type control)	17558		
Grease retainer (P.T.O.)	7274	Grommet (speedometer cable)	14567		
Grease seal (diff. shaft)	4021	Grommet (speedometer cable)	14602		
Grease seal (diff. shaft)	4072	Grommet (speedometer cable)	14604		
Grease seal (u/joint spider)	7078	Grommet (speedometer cable)	14606		
Grille (front fender)	16034-35	Grommet (speedometer cable)	17266		
Grille (front fender horn)	16156	Grommet (starter sw. cont.)	14605		
Grille (radiator)	8150	Grommet (strtr sw. push rod)	11480		
		Grommet (starter switch rod)	14604		
Grille (radiator)	8151	Grommet (vent line frame)	14607	Handle (fuel valve)	9191
Grille (radiator)	8200-07	Grommet (windshield wiper)	16822	Handle (hood)	8215
Grille (radiator)	8242	Grommet (windshield wiper)	17511	Handle (hood)	16624
Grille (radiator)	8427	Grommet (windshield wiper)	17515	Handle (hood catch)	16644-45
Grommet (air deflector)	14615	Grommet (windshield wiper)	17518	Handle (hood lock)	16866
Grommet (airline)	14604	Grommet (windshield wiper)	17549	Handle (jack)	17081
Grommet (air & speedo. cable)	14567	Grommet (windshield wiper)	17558	Handle (lighting & horn sw.)	3616
Grommet (battery to switch)	14607	Grommet (windshield wiper)	17562	Handle (radiator shell catch)	8350-51
Grommet (brake rod)	17266	Grommet (w/s wiper conn. arm)	17577	Handle (spotlight)	15350
Grommet (bumper arm)-front	17772-73	Grommet (w/s wiper tube)	14602-04	Handle (spotlight)	15362
Grommet (bumper arm)-rear	17792-93	Grommet & sleeve-muffler brkt)	5283	Handle (spotlight)	18576
Grommet (carb. control rod)	14605	Grommet & sleeve (rad. brace)	5283	Handle (wheel nut wrench)	17034
Grommet (choke control)	14610	Ground cable (battery)	14301	Hanger (front bumper)	17752
Grommet (choke & throttle)	14612	Ground (hydraulic pump)	14519	Hanger (front bumper)	17760
Grommet (chk. & thrttl. rod)	14604	Guard (brake bstr. valve disc)	2393	Hanger (front spring)	5715
Grommet (choke & throttle rod)	14605	Guard (bumper bar)	17985	Hanger (front spring)	5465
Grommet (coil to dist.)	14604	Guard (bumper bar)	17996-97	Hanger (inner frame)	17925-26
Grommet (control rod dash)	9719	Guards (bumper end)	18383	Hanger (outer frame)	17958-59
Grommet (cowl lamp bracket)	13324	Guard (coupling shaft)	4690	Head (cylinder)	6049-50
Grommet (cross sill panel)	14610	Guard (front license plate)	17770	Head (differential carrier)	4202
Grommet (emergency cable)	2273	Guard (hand brake drum)	2625	Head gasket (cylinder)	6051
Grommet (fuel gauge indic.)	14604	Guard (rear bumper)	17984	Head (speedometer)	17255
				Head (starter drive)	11381

H

CHASSIS PARTS CATALOGUE

Alphabetical Index

Part Name	Basic Part No.	Part Name	Basic Part No.	Part Name	Basic Part No.
Jet (carburetor idling)	9596	Kit (rear shock absorber)	18008-09	Latch (gear shift lever)	7218
Jet (carburetor main)	9534	Kit (rear spring shackle)	5630	Latch (hood top)	16628
Jet (carb. main metering)	9533	Kit (rear wheel brake cyl.)	2128	Leaf (auxiliary spring)	5589-93
Jet (carburetor power)	9594	Kit (road lamp)	18207	Leaf (auxiliary spring)	5600-01
Jet (compensator)	9575	Kit (roadlamp bracket)	18160	Leaf (front spring)	5310
Jet (power)	9594	Kit (sediment bulb)	9155	Leaf (front spring)	5333
Jewel (hdlamp ind. light)	13586	Kit (spare wheel carrier)	1459	Leaf (rear spring)	5560
Joint (universal)	7088	Kit (spindle bolt & bushing)	3111	Leaf (rear spring)	5602-13
Joint (universal)	7090	Kit (spotlight)	18552	Lens (back up lamp)	15514
Journal (differential)	4211	Kit (thermostatic cont. fan)	8665	Lens (clearance lamp)	18735
Journal (universal joint)	7084-87	Kit (tie rod end)	3289		
K		Kit (tire repair)	17012	Lens (cowl lamp)	13308
		Kit (tire & fire unit)	18365	Lens (dome lamp)	13783
		Kit (universal joint)	7039	Lens (headlamp)	13060
		Kit (vacuum shift parts)	4007	Lens (license plate lamp)	13564
		Kit (water pump repair)	8591	Lens (parking lamp)	13082
		Kit (water pump repair)	18515	Lens (parking lamp)	13208
		Kit (wheel brake cyl.)	2221	Lens (rear lamp)	13445
		Kit (windshield washer)	18293	Lens (rear lamp-red)	13450
		Kit (w/s wiper)	17464-65	Lens (rear lamp-white)	13445
		Kit (w/s wiper)	17502	Lens ret. & cover (speedo.)	17254
Key (drive pinion)	4243	Kit (w/s wiper vac. tank)	17639	Lens & rim (dome lamp)	13779
Key (ign. switch lock)	11586	Knob (choke control & insert)	9703	Lens & rim (dome lamp)	13780
Key (main shaft washer)	7101	Knob (clock)	15032	Lens (road lamp)	15215
Key (rear axle shaft)	4243	Knob (heater defroster)	18562	Lens (spot light)	18565
Key (rear hub)	4243	Knob (hot water heater)	18519	Lever assy (w/s wiper)	17582-83
Key (spare wheel lock)	18306	Knob (ignition lock switch)	3690	Lever (accelerator shaft)	9739
Key (spare whl. & tire lock)	3685	Knob (inst. panel lamp sw.)	13741	Lever (brake)	2084
Key (speedometer drive)	4061	Knob (light switch & insert)	11661	Lever (brake camshaft)	2235-6
Key (steering wheel)	3609	Knob (throttle cont & insert)	9778	Lever (brake camshaft ext.)	2246-7
Key (steering & ignition)	3685	Knob (underseat htr. control)	18542	Lever (brake cross shaft)	2496-97
Kicker (carb. throttle)	9597	Knob (w/s wiper control)	17513	Lever (brake operating)	2088-89
King pin	3115-16	Knuckle (universal joint)	4841		
Kit (back up lamp)	18275	L		Lever (carb. accel. pump)	6856
Kit (brake)	18370			Lever (carb. accel. pump)	9531
Kit (brake booster cyl)	2337			Lever (carburetor choke)	9548
Kit (brake booster hyd. cyl.)	2422			Lever (carb. hand throttle)	9615
Kit (brake booster repair)	2309			Lever (carburetor idler)	9584
Kit (brake lining)	2007			Lever (carb. pump operating)	9583
Kit (brake master cyl. repair)	2004			Lever (clutch pedal shaft)	7524
Kit (brake vac. booster)	18161			Lever (elect. w/s wiper sw.)	17583
Kit (drg. lk. & spile. end)	3290			Lever (emergency brake)	2103
Kit (drag link & tie rod end)	3290			Lever (emergency brake)	2636
Kit (electrical wiring)	14293-4	Lace (radiator grille hood)	8222	Lever (emergency brake)	2646-47
Kit (engine governor)	18204	Lamp (back up lamp)	15500		
Kit (front shock absorber)	18006-07	Lamp (cowl)	13302	Lever (gear shift)	7202
Kit (front shock absorber)	18124-25	Lamp (dome)	13776-77	Lever (gear shift)	7209-10
Kit (fuel pump repair)	9349	Lamp kit (eng. compt. lamp)	15700	Lever (gear shift)	7302-03
Kit (grille insect screen)	8198	Lamp (instrument panel)	13705	Lever (gov. carb. throttle)	18213
Kit (horn & bracket)	13823	Lamp (license plate)	13550	Lever (hand brake)	2642-3
Kit (hot water htr. adapter)	18451	Lamp (luggage compartment)	13506	Lever (hand brake)	2780
Kit (license plate frames)	18350	Lamp (parking)	13200-01	Lever (hand brake)	2816
Kit (license plate frames)	18480	Lamp (rear)	13402-05	Lever (hand brake)	2833-4
Kit (oil filter)	18671	Lamp (rear)	13407	Lever (hand throttle)	9805
Kit (poppet valve repair)	2433	Lamp (utility)	15550	Lever (hood catch oper.)	16636
Kit (power take-off)	7275	Lamp (warning)	18702	Lever (ignition switch)	3735
		Lamp & bracket (cowl)	13302		

Alphabetical Index

Part Name	Basic Part No.	Part Name	Basic Part No.	Part Name	Basic Part No.
Pad (spring anti-squeak)	5599	Pin (fuel pump rocker arm)	9378	Pipe (heater exh. cross over)	18521
Pad (tail light bracket)	13449	Pin (gear shift conn. rod)	7331	Pipe (heater muffler inlet)	18483
Pad (w/s wiper chain housing)	17556	Pin (gear shift housing)	7224	Pipe (hot air heater intake)	18468
Pan assy. (engine oil)	6675	Pin (gear shift hsg. guard)	7206	Pipe (muffler connector)	5277
Pan (engine)	6774-5-6	Pin (gear shift interlock)	7235	Pipe (master cyl. fitting)	2234
Pan gasket (engine oil)	6710-11	Pin (gear shift lever)	7221	Pipe (master cyl. fitting)	2352
Pan gasket set (engine oil)	6781	Pin (gear shift tube)	7219	Pipe (muffler inlet)	5267
Panel (front fender)	16140-41	Pin (gear shift tube)	7337	Pipe (muffler outlet)	5253
Panel (front fender apron)	16043	Pin (gen. & strtr. end plate)	10088	Pipe (muffler outlet)	5255
Panel (front fender apron)	16052	Pin (hand brake lever)	2787	Pipe (oil filler)	6763
Panel (hood)	8327	Pin (high speed clutch plate)	4154	Pipe (oil filter)	18666-67
Panel (hood air deflector)	16613	Pin (hood locking handle)	16763	Pipe (oil return)	6645
Panel (hood auxiliary catch)	8162	Pin (ignition lock cylinder)	3729	Pipe (radiator)	8290-91
Panel (hood side)	16618-19	Pin (ignition lock sleeve)	3743	Pipe (radiator filler)	8360-67
Panel (radiator)	16140-41	Pin (lever guide spring)	7324	Pipe (radiator overflow)	8075
Panel (radiator grille)	8152	Pin (oil pump gear)	6661	Pipe (radiator o/flow)	8081
Panel (radiator grille)	8188-90	Pin (pedal clevis)	7533	Pipe (radiator to cylinder)	8436-37
Panel (radiator grille)	8202-04	Pin (piston)	6135	Pipe (valve chamber vent.)	6796
Panel (radiator grille)	8211	Pin (planetary gear)	4029	Piston (air valve)	9538
Panel (radiator grille)	8241	Pin (pump link)	9579	Piston (brake booster cyl.)	2368
Panel (rad. grille top)	8177	Pin (radius rod retaining)	3441	Piston (carburetor pump)	9631
Parking lamp	13200-01	Pin (rear spring shackle)	5780	Piston (master cylinder)	2169
Pawl (hand brake lever)	2786	Pin (shackle pin locking)	5782	Piston (pump)	9572
Pedal (accelerator)	9735	Pin (shift lever pivot)	4099	Piston (rear brake cylinder)	2195-6
Pedal (accelerator assy.)	9723	Pin (sldg. clutch shift fork)	4053	Piston (wheel brake cyl.)	2194-96
Pedal (brake)	2455	Pin (spindle bolt locking)	3122	Piston Chart	6110
Pedal (clutch)	7520	Pin (spring seat lock)	5798-9	Piston pin	6135
Pedal spring (brake)	2456	Pin (starter drive pinion)	11365	Piston Pin Chart- Page 242	
Pedal spring (clutch)	7523	Pin (throttle control lever)	9819	Piston, Pin & Retainer Chart	6108
Perch (front spring)	3030	Pin (transfer lever)	2835		
Pet cock (radiator)	8115	Pin (trans. countershaft)	7155	Piston Pin & Retainer Chart- Page 240	
Pin (brake emergency link)	2105	Pin (trans. thrust washer)	7073	Piston Ring Set Chart	6149
Pin (brake operating)	2075	Pin (shifter arm pivot)	77241	Piston Ring Set Chart- Page 244	
Pin (brake shoe anchor)	2027	Pin (vane check)	9547	Pivot (rev. gear shifter arm)	77236
Pin (brake shoe roller)	2045	Pin (wheel brg. nut lock)	4256	Plate (accel. foot rest)	9770
Pin (brake shoe spring)	2069	Pin, Piston & Retainer Chart	6108	Plate (arm to back bar)	17916
Pin (carburetor float hinge)	9558	Pinion (bevel drive)	4610	Plate (aux. catch striker)	16904
Pin (clutch & brake pedal)	2451	Pinion (differential)	4215	Plate (brake anchor pin)	2030
Pin (dist. terminal housing)	12126	Pinion (driving)	4609	Plate (brake booster piston)	2394-5
Pin (dist. weight pivot)	12183	Pinion (starter drive)	11367		
Pin (driv. gear thrust block)	4189	Pipe (brake)	2269	Plate (brake housing)	2013
Pin (drive pinion brg. lock)	4256	Pipe (c/case ventilation)	6762	Plate (brake housing-front)	2012
Pin (drive shaft)	4607	Pipe (c/shaft-ball check type)	6328	Plate (brake housing-rear)	2214
Pin (drive shaft coupling)	4707	Pipe (c/shaft rear brg. oil)	6326	Plate (bumper bar)	17756
Pin (dual high planet gear)	4856	Pipe (cylinder block oil)	6021	Plate (camshaft thrust)	6269
Pin (dual high shifter)	2835	Pipe (dist. drain)	12126	Plate (carburetor choke)	9549
Pin (emergency brake lever)	2639	Pipe (fuel line)	2269	Plate (carb. main air choke)	9545
Pin (emergency lever)	2105	Pipe (fuel pump to carb.)	9369	Plate (carburetor throttle)	9585
Pin (emergency lever)	2107	Pipe (fuel tank)	9023	Plate (choke mtg. adapter)	9676
Pin (exh. control valve coil)	9463	Pipe (fuel tank)	9230	Plate (clutch pressure)	7563
Pin (flywheel dowel)	6387	Pipe (fuel tank filler)	9032	Plate (coupling shaft supp.)	4831
Pin (flywheel hsg. dowel)	6397	Pipe (fuel tank sed. bulb)	9240	Plate (distributor breaker)	12151
Pin (fuel filler lid hinge)	16376	Pipe (heater distributing)	18471-72		

CHASSIS PARTS CATALOGUE

Alphabetical Index

Part Name	Basic Part No.	Part Name	Basic Part No.	Part Name	Basic Part No.
Plate (distributor terminal)	12116	Plate (starter brush end)	11049	Plug (trans. gear shaft)	7238
Plate (drive spring anchor)	11372	Plate (starter end)	11050	Plug (trans. shifter shaft)	7012
Plate (emer. brake carrier)	2600-01	Plate (starter rear end)	11130	Plug (valve chamber cover)	6053
Plate (emer. cable spring)	2113	Plate (steering housing end)	3568	Plug (valve chamber cover)	6527
Plate (engine oil pan sealer)	6892-93	Plate (support aux. spring)	6031	Plug (water valve hole)	8263
Plate (engine rear)	7007	Plate (switch lever ret.)	3736	Plug (water pump)	6053
Plate (engine rear support)	5099	Plate (synchronizer shifting)	77159	Plug (water pump)	8519
Plate (fender shield swivel)	18998	Plate (trans. cluster gear)	7128	Plug & handle (sediment bulb)	9177
Plate (front brake housing)	2011-3	Plate (trans. c/shaft gear)	7129	Plug & handle (sediment bulb)	9181
Plate (front fender name)	16079	Plate (trans. gear shift)	7235	Plug & handle (sediment bulb)	9185
Plate (front spring)	5458	Plate (vacuum w/s mounting)	17524	Plunger (camshaft thrust)	6275
Plate (fuel pump valve)	9361	Plate (ven. pipe hole)	6539	Plunger (carb. choke lever)	9537
Plate (fuel tank gauge)	9003	Plate (wiper ret. & spring)	17450	Plunger (dist. vacuum brake)	12220
Plate (generator brush)	10072	Plate & bracket (brake hsg.)	2011-3	Plunger (oil relief valve)	6674
Plate (gen. end)	10050	Plate & bracket (brake hsg.)	2211	Plunger (oil relief valve)	6663
Plate (gen. end)	10129	Plate & spring (hood catch)	16680-81	Plunger (pump)	9570
Plate (gen. end plate brg.)	10098	Plate & terminal	10533	Plunger (shift fork)	4163
Plate (generator front end)	10139	Pliers	17025	Plunger (shifter shaft lock)	7233
Plate (headlamp socket)	13125	Plug (air horn)	9523	Plunger (top catch)	16648
Plate (high speed clutch)	4040	Plug (battery filler)	10720	Plunger (trans. interlock)	7233
Plate (hood top handle)	8218	Plug (bowl drain)	9590	Plunger (trans. reverse gate)	7247
Plate (horn button index)	3645	Plug (brake booster hyd. cyl.)	2369	Plunger (trans. thrust washer)	7073
Plate (ignition switch)	3728	Plug (bumper bar)	17762	Plunger (vacuum control)	4042
Plate (ign. switch face)	11556	Plug (camshaft bearing)	6266	Plunger & guide bushing lock	4098
Plate (ignition switch name)	3728	Plug (carburetor chrome shaft)	9941	Plunger & oil hole cover	4063
Plate (license plate lp. trim)	13590	Plug (carburetor drain)	9562	Point (cut out unit)	10535
Plate (light switch contact)	11664	Plug (carb. metering jet)	9522	Point (dist. breaker)	12163
Plate (light switch contact)	11673	Plug (c/shaft oil hole)	6307	Point (regulator contact)	10653
Plate (master cyl piston stop)	2188	Plug (cyl. block oil hole)	6024	Point (regulator contact)	10663
Plate (oil pan cleanout)	6645	Plug (cyl. block oil line)	6026	Point set (dist.)	12107
Plate (oil pump cover)	6616	Plug (cylinder head)	6053	Point set (dist.)	12171
Plate (parking lens locking)	13232	Plug (cyl. oil pipe-front)	6043	Point set (dist.)	12199
Plate (radiator grille)	8221	Plug (defroster)	18526	Point & bracket (dist.)	12218-19
Plate (radiator grille name)	8216	Plug (diff. cover vent.)	4022	Point & post (cutout contact)	10541
Plate (radiator name)	8212-13	Plug (diff. oil dist. ret.)	4161	Point & screw (cutout unit)	10609
Plate (radiator ornament)	8218	Plug (dist. breaker point)	12138	Point & screw (cutout unit)	10616-17
Plate (rad. top air defl.)	8236	Plug (dist. oil hole)	12136	Point & screw (dist. contact)	12172
Plate (rear brake anchor pin)	2228-29	Plug (drag link ball)	3328	Pole piece (generator)	10041
Plate (rear brake housing)	2211	Plug (floor pan spacer)	3029	Positive cable (battery)	14301
Plate (rear brake housing)	2213	Plug (flywheel housing drain)	6403	Post regulator contact&point	10565
Plate (rear lamp)	13421	Plug (fuel pump)	9362	Power (take off assy.)	7275
Plate (rear lamp plunger)	13616	Plug (gen. brush end plate oil)	10146	Pump (oil)	6600
Plate (rear lens retainer)	13476	Plug (generator end plate)	10149	Protector (fuel pump diaph.)	9391-92
Plate (rear spring clip)	5708	Plug (headlamp)	14584	Pulley (crankshaft)	6312
Plate (reg. unit armature)	10568	Plug (main body)	9523	Pulley (fan & water pump)	8606
Plate (road lamp)	15204	Plug (oil filler hole)	6541	Pulley (generator)	10130
Plate (road lamp)	15211	Plug (oil filler pipe)	6528	Pulley (water pump)	8509
Plate (shift lever bracket)	4278	Plug (oil pan drain)	6730	Pump (carburetor accelerator)	9630
Plate (shock abs. clip)	18126	Plug (oil relief valve)	6666	Pump (fuel-assembly)	9350
Plate (spare wheel)	1390	Plug (oil relief valve)	6672	Pump (oil-assembly)	6600
Plate (spare whl. carr. supt.)	1413	Plug (power take off housing)	7260	Pump (tire)	17052
Plate (spare wheel cover)	1398	Plug (spindle conn. rod seat)	3328	Pump (water)	8501-02
Plate (spring anchor)	5468	Plug (steering gear filler)	3538		

Alphabetical Index

Part Name	Basic Part No.	Part Name	Basic Part No.	Part Name	Basic Part No.
R		Register (hot air heater)	18497	Retainer (coup. shaft grease)	4813
		Regulator assy (generator)	10505	Retainer (cowl lamp lens)	13316
		Regulator contact point	10653-63	Retainer (crankshaft brg.oil)	6335-36
		Reinforcement (bumper bar)	17957	Retainer (distributor cam)	12177
		Reinforcement (cross member)	5021	Retainer (dist. retard disc)	12207
		Reinforcement (cross member)	5097	Retainer (dist. rotor)	12213
		Reinforcement (cross member)	5050-52	Retainer (dist. vac. rod)	12388
		Reinforcement (cross member)	5135-36	Retainer (dist. vacuum seal)	12135
				Retainer (distributor weight)	12212
Race (differential bearing)	4222-41	Reinforcement (cross member)	5347	Retainer (dome lamp lens)	13784
Race (drive shaft bearing)	4672	Reinforcement (engine rad.rod)	5137	Retainer (drag link grease)	3332
Race (driving pinion brg.)	4616	Reinforcement (fender apron)	16156	Retainer (drive gear brg.)	7047-50
Race (driving pinion pilot)	4626	Reinforcement (front fender)	16072-73	Retainer (drive gear grease)	7052
Race (front wheel bearing)	1202-17	Reinforcement (hood side)	16840-41	Retainer (drive pinion shaft)	4674
Race (rear wheel bearing)	1239-43	Reinforcement (oil pan plate)	6642	Retainer (drive shaft grease)	4686
Race (steering gear brg.)	3552-53	Reinforcement (radiator)	8044-45	Retainer (drive shaft nut)	4669
Race (transfer shaft brg.)	7168-69	Reinforcement (rad. grille)	8221	Retainer (drive shaft pinion brg)	4668
Race (universal joint brg.)	7099	Reinforcement (rad. grille)	8257	Retainer (driv. pinion grease)	4676
Radiator assy.	8005	Reinforcement (rear fender)	16360-61	Retainer (emergency lever pin)	2106
Radiator cap	8100	Reinforcement (rear lp. brkt)	13463	Retainer (end plate brg.)	11134
Radiator Grille Insect Screen	8198	Reinforcement (rear lp brkt.)	13468	Retainer (flywheel dowel)	7609
Radiator hose	8284-86	Reinforcement (running board)	16548	Retainer (front wheel grease)	1190
Radiator hose	8333	Reinforcement (strg. gear)	3508	Retainer (fuel pump arm)	9379
Radio	18800	Relay (horn)	13842	Retainer (fuel pump oil seal)	9468
Radio Antenna	18813	Relay & bracket (horn)	13853	Retainer (fuel pump valve)	9356
Ratchet(carb.main adjustment)	9536	Relay switch (starter)	11450	Retainer (fuel pump valve spg)	9362
Ratchet (crankshaft)	6319	Repair kit (carburetor)	9590	Retainer (fuel tank)	9231
Rear axle housing	4010-14	Resistor (ignition)	12260	Retainer (gear shift fork)	7284
Rear Bumpers	17757	Resistor (reg. absorbing)	10594	Retainer (gear shift lev.boot)	7243
Rear Door Safety Lock	18333	Resistor (regulator field)	10570	Retainer (gear shift tube)	7348
Rear Fender Bolts,Nuts & Washers- Page 605		Resistor (ignition coil)	12250	Retainer (generator brush)	10075
Rear Fender Shield	18956	Rest (accelerator foot)	9716	Retainer (gen. end plate)	10214
Rear lamp	13402-07	Retainer (ash receptacle)	18956	Retainer (gen end plate brg.)	10098
Rear Lamp Chart- Page 542		Retainer (brake bstr.piston)	2378	Retainer (gen end plate brg.)	10113
Rear Spring Clamp Chart- Page 199		Retainer (brake bstr.piston)	2429	Retainer (gen end plate brg.)	10115
Rear Spring Clip Chart- Page 195		Retainer (brk.bstr.push rod)	2301-81	Retainer (gen end plate brg.)	10116
Rear Spring Leaf Chart- Page 184		Retainer (brake bstr.spring)	2423	Retainer (gen end plate brg.)	10117
Rear Spring Leaves Chart- Page 192		Retainer (brake bstr.spring)	2429	Retainer (gen end plate brg.)	10121
Rear Wheel Hub Bolts & Studs Chart- Page 5		Retainer (brake bstr. valve)	2398	Retainer (gen end plate brg.)	10124
Receptacle (ash)	18900-50	Retainer (brk.bstr.valve cap)	2415	Retainer (gen end plate brg.)	10155
Reflector (back up lamp)	15504	Retainer (brush holder)	10076	Retainer (head lamp gasket)	13067
Reflector (cowl lamp)	13315	Retainer (carb. accel. pump)	9632	Retainer (head lamp lens)	13061
Reflector (headlamp)	13025	Retainer (carb. check ball)	9575	Retainer (headlamp lens)	13062
Reflector (headlamp)	13027	Retainer (carb. float spring)	9673	Retainer (hdlp. swivel bolt)	13015
Reflector (headlamp)	13028	Retainer (carb. idler lever)	9682	Retainer (hood hinge rod)	8220
Reflector (rear)	13380	Retainer (carb. pump cup)	9642	Retainer (hood hinge rod)	16735
Reflector (road lamp)	15218	Retainer (carb. pump link)	9599	Retainer (hood orn. plate)	8219
Reflector (spotlight)	15218	Retainer (choke lever swivel)	9549	Retainer (hood top moulding)	16960-64
Reflector (spotlight lens)	18568	Retainer (clearance lamp)	18737	Retainer (horn to fender)	13917
		Retainer (clock)	15001-05	Retainer (ignition wire)	12271
		Retainer (clutch pilot brg.)	7609	Retainer (lighting switch)	3644
		Retainer (clutch shaft)	4150	Retainer (mstr.cyl.boot snap)	2186
		Retainer (cplg. shaft brg.)	4812		

CHASSIS PARTS CATALOGUE

Alphabetical Index

Part Name	Basic Part No.	Part Name	Basic Part No.	Part Name	Basic Part No.
Retainer (master cyl. spring)	2185	Ring (brake booster snap)	2427	Rod (brake cross shaft)	2508
Retainer (oil pump screen)	6620	Ring (brake lever dust)	2087	Rod (brake master cyl. push)	2143
Retainer (parking lamp lens)	13232	Ring (choke sleeve ret.)	9573	Rod (brake pedal)	2463
Retainer (pinion bearing)	4629	Ring (coupling shaft)	4820	Rod (brake ped. to cross shaft)	2462
Retainer (piston pin)	6140	Ring (dist. cap retaining)	12115	Rod (brake pedal to shaft)	2465
Retainer (rad. filler pipe)	8368	Ring (driving pinion pilot)	4627	Rod (carburetor choke)	9700
Retainer (radiator grille)	8221	Ring (hdlp. bulb retaining)	13018	Rod (carb. choke control)	9700
Retainer (radiator grille)	8243	Ring (headlamp grommet)	13094	Rod (carb. fast idle)	9598
Retainer (radiator rod)	8140-41	Ring (headlamp reflector)	13030	Rod (carburetor pump)	9526
Retainer (rear engine supp.)	5101	Ring (manifold to cyl. block)	9440	Rod (carburetor pump)	9531
Retainer (rear fender shield)	18994	Ring (P.T.O. shaft lock)	7261	Rod (choke control)	9705
Retainer (rear lamp)	13420	Ring (rear brake dust)	2234	Rod (clutch pedal)	7521
Retainer (rear lamp lens)	13439	Ring (road lamp)	15229	Rod (clutch pedal release arm)	7530
Retainer (rear lamp lens)	13456	Ring (spare tire cover)	1396	Rod (connecting)	6200
Retainer (rear wheel grease)	1175	Ring (spare wheel lock)	18303	Rod (emergency brake lever)	2853
Retainer (ride stab. bush.)	3044	Ring (speed.drive gear snap)	17293	Rod (emergency brake lever)	2864
Retainer (sed. bulb screen)	9175	Ring (spot light lens)	18569	Rod (engine radius)	6027-8
Retainer (shift lever pad)	4283	Ring (spring lock)	11373	Rod (engine radius)	6044
Retainer (spare wheel lock)	18323	Ring (stab. bushing retainer)	3045	Rod (engine radius)	6045
Retainer (speedo.drive gear)	17286	Ring (starter drive pinion)	11370	Rod (front brake)	2495
Retainer (speedo. gear shaft)	17274	Ring (starter drive screw)	11371	Rod (front brake cable)	2495
Retainer (speedometer lens)	17258	Ring (starter drive spring)	11380	Rod (front fender bracket)	16067
Retainer (spindle bolt felt)	3288	Ring (strg. eccentric adj.)	3587	Rod (front radius)	3405
Retainer (spindle con.grease)	3332	Ring (switch plate)	11557	Rod (front shift)	4134
Retainer (strg. gear seal)	3527	Ring (synchronizer)	7107	Rod (fuel pump push)	9393
Retainer (strg. gear seal)	3598	Ring (tire cover inner)	1350	Rod (fuel pump push)	9400
Retainer (strg. shaft felt)	3527	Ring (tire cover outer)	1351	Rod (gear shift)	7326-28
Retainer (tire cover moulding)	1356	Ring (universal joint)	7096	Rod (gear shift lever latch)	7212
Retainer (trans.bearing)	4813	Ring (water pump brg. ret.)	8537	Rod (hand brake lever)	2821
Retainer (trans. bearing)	7085	Ring (water pump brg. snap)	8531	Rod (hand brake lever)	2822
Retainer (trans. c/shaft)	7155	Ring (water pump seal clamp)	8572	Rod (hand brake band adj.)	2642
Retainer (trans.shaft brg.)	7049-50	Ring (water pump seal snap)	8574	Rod (hand brake lever pawl)	2785
Retainer (univ. joint grease)	7083	Ring (wheel)	18303	Rod (hood catch operating)	16674
Retainer (valve guide bushing)	6512	Ring (wheel grease ret.)	1175	Rod (hood hinge)	16630
Retainer (valve spring)	6514	Ring (wheel grease ret.)	1180	Rod (intermediate shift)	4136
Retainer (water pump brg.)	8540	Ring (wheel grease retainer)	4245	Rod (power take-off lever)	7269
Retainer (water pump bearing)	8576	Ring (wheel rim)	1099	Rod (radiator brace)	8133
Retainer (water pump spring)	8561	Rivet (carb. throttle link)	9579	Rod (rear brake)	2499-500
Retainer (wheel brg.grease)	1197	Rivet (dist. breaker arm)	12155	Rod (rear radius)	4750-51
Retainer (wheel moulding)	1356	Rivet (distributor cap clamp)	12145	Rod (rear shift)	4135
Retainer (white lens)	13446	Rivet (dist. cont. point)	12238	Rod (rocker arm)	2495
Retainer (worm grease)	4700	Rivet (gen. brush holder)	11069	Rod (service brake)	2499
Retainer (worm thrust brg.)	4695	Rivet (strg. worm eccentric)	3584	Rod (service brake shaft)	2511
Retainer (w/s wiper spring)	17530	Roadlamp kit	18207	Rod (spark control)	9757
Retainer (w/s wiper spring)	17580	Rod (accelerator control)	9754	Rod (starter switch)	11470
Retainer (worm roller brg.)	4622	Rod (accel. shaft to pedal)	9727	Rod (throttle)	9775
Retainer, Piston & Pin Chart	6108	Rod (accel. to bell crank)	9735	Rod (throttle control)	9779
Rim (head lamp bulb ret.)	13018	Rod (accel. to carb.)	9740-42	Rod (w/s wiper conn.)	17537
Rim (headlamp lens)	13043-45	Rod (accel. to carburetor)	9747	Rod (w/s wiper control stem)	17572
Rim (roadlamp)	15214	Rod (bell crank to carb.)	9772	Rod (w/s wiper spring)	17532
Rim (spotlight)	15328	Rod (brake booster push)	2377	Roller (brake shoe)	2023
Rim (tail lamp lens)	13448	Rod (brake cross shaft)	2499-501	Roller (clutch shift fork)	4058
Ring (brake booster hyd.)	2409			Roller (trans. main pilot brg)	7120

CHASSIS PARTS CATALOGUE

Alphabetical Index

Part Name	Basic Part No.	Part Name	Basic Part No.	Part Name	Basic Part No.
Shield (front splash)	16527	Sleeve (cylinder)	6055	Socket (license plate lamp)	13412
Shield (fuel gauge)	9325	Sleeve (dist. cam shaft conn)	12195	Socket(lic.plate lamp & brkt)	13560
Shield (hdlamp indic. light)	13583	Sleeve (drag link adj.)	3310	Socket (radius rod ball)	3430
Shield (ignition cable)	12299	Sleeve (drive shaft bearing)	4655	Socket (rear lamp)	13410
Shield (oil pump)	6631	Sleeve (gear shift lever)	7336	Socket ring (hdlamp bulb rim)	13034
Shield (radiator grille)	8208	Sleeve (inter.&high cl. hub)	7106	Socket & wiring (headlamp)	13076
Shield (radiator grille)	8240	Sleeve (oil pump drive shaft)	6561	Socket & wiring (parking lamp)	13234
Shield (radiator shell)	8209	Sleeve (pinion & brg. cups)	4614	Socket & wiring (rr. deck lp)	13506
Shield (radiator shell)	8225	Sleeve (radius rod ball cap)	3435	Socket & wiring (rear lamp)	13412
Shield (rad. splash)	16550	Sleeve (rear wheel hub)	1236	Solenoid switch (starter)	11450
Shield (rad. to cross mem.)	16550	Sleeve (starter drive)	11357	Spacer (aux. to rear spring)	5594
Shield (rear lamp wire)	13467	Sleeve (steering column brg.)	3518	Spacer (brake wedge stud)	2254
Shield (rear spring)	16544-45	Sleeve (steering gear adj.)	3553	Spacer (bumper arm)	17910
Shield (road lamp bulb)	15222	Sleeve (steering shaft)	3532	Spacer (bumper bar)	17759
Shield (running board)	16532-38	Sleeve (steering worm adj.)	3586	Spacer (control wire)	4080
Shield (shell to cross mem.)	16550	Sleeve (trans. inter. gear)	7104	Spacer (deck door water seal)	13557
Shield (shell to cross mem.)	16554	Sleeve (water pump shaft brg)	8535	Spacer (drive pinion brg.)	4537
Shield & bracket (rad. shell)	8242	Sleeve (wheel bearing)	1236	Spacer (drive shaft guard bar)	4677
Shim (brake shaft bracket)	2479	Sleeve (wiring)	14455	Spacer (engine rear support)	5093
Shim (connecting)	6220	Sleeve (worm roller bearing)	4616	Spacer (engine to trans.)	7014
Shim (c/shaft main bearing)	6340	Slinger (crankshaft oil)	6310	Spacer (fan)	8621
Shim (c/shaft main bearing)	6346	Slinger (water pump shaft)	8550	Spacer (frame side member)	5115
Shim (drive pinion bearing)	4536	Snap ring (brake master cyl.)	2174	Spacer (frame side member)	5116
Shim (engine radius rod)	6045	Snap ring (clutch bearing)	7045	Spacer (frame to floor pan)	5122-23
Shim (flywheel housing)	6400	Snap ring (clutch hub)	7109	Spacer (front fender)	16087
Shim (ignition lock)	3682	Snap ring (clutch pedal shaft)	7547	Spacer (front spring)	5021
Shim (radiator name plate)	8214	Snap ring (diaphragm)	4097	Spacer (front spring)	5308
Shim (steering shaft)	3559	Snap ring (dist. adv. hsg.)	12146	Spacer (fuel tank filler)	9134
Shim (steering shaft brg.)	3595	Snap ring (gen end plate brg)	10136	Spacer (gear shift housing)	7224
Shock absorber kit	18006	Snap ring (gen end plate brg)	10163	Spacer (gen. end plate)	10097
Shock absorber kit	18125	Snap ring (gen. pulley)	10096	Spacer (gen. pulley)	10144
Shock absorber link	18050-66	Snap ring (gen. pulley)	10099	Spacer (hood handle)	16650
Shock Absorber Link Chart- Page 662		Snap ring (speedo driv. gear)	7160	Spacer (hood hinge bracket)	16806-07
Shock (front)	18045-46	Snap ring (trans. bearing)	7026-30	Spacer (horn brkt. spring)	13827
Shock (front & rear)	18015-16	Snap ring (trans. bearing)	7064	Spacer (horn brkt. to apron)	13918-19
Shock (rear)	18080-81	Snap ring (trans. brg. ret.)	7070	Spacer (horn to fender apron)	13914
Shoe (brake & lining)	2019	Snap ring (trans. gear brg.)	7026-30	Spacer (road lamp)	15208
Shoe (dist. vacuum brake)	12222	Snap ring (trans. gear brg.)	7045-6	Spacer (ign. resistor)	12292
Shoe (rev.gear shifter arm)	77235	Snap ring (trans. gear ret.)	1180	Spacer (hot water heater)	18450
Shoe & lining (brake forward)	2018	Snap ring (trans. pilot brg.)	7063	Spacer (radiator grille)	8258
Shroud (fan)	8146	Snap ring (trans. synchro.)	7059	Spacer (radiator grille)	8434
Shroud (hot air heater)	18543	Snap ring (trans. synchro.)	77158	Spacer (radius rod ball)	3442
Silencer (hot air heater)	18459	Snap ring (u/joint brg.)	7096	Spring (radius rod ball cap)	3445
Silencer (lighting sw. tube)	3529	Snap ring (vac. cont. valve)	4065	Spacer (rear bumper)	17790
Silencer (windshield wiper)	17595	Snap ring (water pump hsg.)	8576	Spacer (rear bumper)	17799
Sleeve (back up lamp wire)	14455	Snap ring (wheel grease ret.)	1180	Spacer (rear lamp)	13470-71
Sleeve (brake lever clevis)	2789	Socket (accel. control rod)	9744	Spacer (rear spring)	5769
Sleeve (brake pedal bracket)	2470	Socket (cowl lamp)	13318	Spacer (running board)	16590
Sleeve (carb. rod)	9705	Socket (drag link ball)	3320	Spacer (running board brkt.)	16520-22
Sleeve (choke)	9570	Socket (headlamp)	13075	Spacer (second speed brg.)	77160
Sleeve (coupling shaft supp.)	4826	Socket (hdlamp indic. light)	13580	Spacer (shift fork)	4103
Sleeve (cowl lamp wire)	14487	Socket (hood catch)	16769	Spacer (shock abs.link bshng)	18063
		Socket (inst. panel lamp)	13710	Spacer (spring clamp)	5731

Alphabetical Index

Part Name	Basic Part No.	Part Name	Basic Part No.	Part Name	Basic Part No.
Spacer (spring clip bar)	5706	Spring (brake master cyl.)	2177	Spring (frt. fender apron brkt.)	8130
Spacer (starter frame)	11143	Spring (brake master cyl. ret.)	2145	Spring (fuel pump diaphragm)	9396
Spacer (steering column)	3514	Spring (brake pedal retract.)	2456	Spring (fuel pump rocker arm)	9380
Spacer (steering worm brg.)	3598	Spring (brake pedal retr.)	2472	Spring (fuel pump valve seat)	9360
Spacer (throttle control rod)	9715	Spring (brake rocker arm)	2523	Spring (fuel tank)	8130
Spacer (torsion bar bracket)	5491	Spring (brake rod)	2503	Spring (fuel tank hold down)	9094
Spacer (trans. main brg.)	7080	Spring (brake rod retracting)	2472	Spring (fuel valve)	9194
Spacer (trans. pilot bearing)	7063	Spring (brake shaft retract.)	2472	Spring (gas fltr. drain screw)	9182
Spacer (trans. shaft gear brg.)	7115	Spring (brake shoe)	2296-7	Spring (gear shift latch)	7208
Spacer (windshield wiper)	17515	Spring (brake shoe hold down)	2066	Spring (gear shift lever)	7219
Spacer (windshield wiper)	17549	Spring (brake shoe hold down)	2125	Spring (gear shift lever)	7227
Spacer (windshield wiper)	17551	Spring (brake shoe retainer)	2125	Spring (gear shift lever gde)	7322
Spare wheel carrier	1459	Spring (brake shoe retract.)	2034-36	Spring (gear shifter shaft)	7234
Spare Wheel Lock	18305	Spring (brake shoe retr.)	2296-7	Spring (generator brush)	10057
Spark plug	12405	Spring (brake shoe return)	2034-5	Spring (gen. brush)	10068
Speaker (radio)	18875	Spring (camshaft plunger)	6276	Spring (hand brake band supt)	2640
Speedometer Casing & Shaft		Spring (carb. accel. pump plung)	9640	Spring (hand brake compress.)	2635
Chart- Page 629		Spring (carb. accel. pump ret.)	9636	Spring (hand brake lever)	2646-7
Speedometer gear chart	17270-71	Spring (carb. adj. rod)	9709	Spring (hand brake lever pawl)	2788
Speedometer Gear Chart- Page 632		Spring (carb. adj. sleeve)	9709	Spring (hand brake lever pawl)	2793
Speedometer Gear Chart- Page 633		Spring (carb. air shutter)	9587	Spring (hand brake release)	2634
Speedometer Gear Chart- Page 634		Spring (carb. choke)	9539-40	Spring (hand brake retract.)	2472
Spider (differential)	4211	Spring (carb. choke plate valve)	9560	Spring (hand brake rod)	2472
Spider (lighting switch)	3643	Spring (carb. choke shaft)	9539	Spring (hand brake rod)	2866
Spider (universal joint)	7084	Spring (carb. choke valve)	9539	Spring (hand brake shaft)	2840
Spider (universal joint)	7087	Spring (carb. float)	9651	Spring (headlamp bulb ring)	13031
Spindle assy.	3105-06	Spring (carb. idle adj. needle)	9578	Spring (head lamp door latch)	13017
Spindle belt	3115-16	Spring (carb. piston expander)	9650	Spring (hdlp. focusing screw)	13101
Spindle bolt & bushing	3111	Spring (carburetor pump)	9571	Spring (headlamp reflector)	13031
Spindle conn. rod end	3270-71	Spring (carb. throttle kicker)	9599	Spring (hood auxiliary catch)	16897
Spindle conn. rod kit	3289	Spring (carb. throttle lever)	9624	Spring (hood catch plunger)	16650
Spindle end kit	3290	Spring (clutch)	7556	Spring (hood lock)	16925
Spindle (fan hub & impeller)	8639	Spring (clutch pedal retract)	7523	Spring (hood support)	16789
Spotlight	18552	Spring (control rod)	3545	Spring (hood top catch)	16635
Spotlight (less bracket)	18552	Spring (clutch release brg.)	7562	Spring (horn armature)	13838
Spring assy. (front)	5310	Spring (clutch release shaft)	7545	Spring (horn armature)	13897
Spring (accelerator)	9737	Spring (cplg. shaft thrust)	4822	Spring (horn button)	3626
Spring (accel. pump plunger)	9640	Spring (diff. carrier cont.)	4160	Spring (horn button index)	14479
Spring (auxiliary)	5588	Spring (dist. breaker arm)	12169	Spring (horn motor)	13818
Spring (back up lamp)	15509	Spring (dist. breaker plate)	12137	Spring (ign. switch lock cyl)	11587
Spring (brake booster)	2392	Spring (dist. breaker plate)	12190	Spring (ign. switch ret.)	11581
Spring (brake booster ret.)	2361	Spring (dist. coil brush)	12012	Spring (inter. & high cl. hub)	7109
Spring (brake booster ret.)	2364	Spring (dist. coil contact)	12006	Spring (lamp socket)	13081
Spring (brake booster ret.)	2375	Spring (dist. primary weight)	12192	Spring (latch operating rod)	16871
Spring (brake booster ret.)	2418	Spring (drag link ball seat)	3327	Spring (lighting sw. spider)	3642
Spring (brake booster valve)	2438	Spring (dual high shifter)	7234	Spring (main adj. needle)	9540
Spring (brake booster valve)	2439	Spring (emergency brake band)	2624	Spring (oil pump drive shaft)	6570
Spring (brake cross shaft)	2472	Spring (eng. compt. lamp)	15706-07	Spring (oil pump ret.)	6620
Spring (brake drum silencer)	1140	Spring (eng. front support)	6032	Spring (oil pump screen)	6628
		Spring (eng. front support)	6035	Spring (power take off)	7272
		Spring (engine stabilizer)	6810	Spring (radiator bolt)	8130
		Spring (exh. control valve)	9449	Spring (rad. filler cover)	8134
		Spring (exh. cont. valve coil)	9467	Spring (radiator grille)	8253



CHASSIS PARTS CATALOGUE

Alphabetical Index

Part Name	Basic Part No.	Part Name	Basic Part No.	Part Name	Basic Part No.
Support (spare wheel brkt.)	1481	Spring (rear)	5560	Step (rear lamp brkt.)	2454
Support (spare wheel carrier)	1469	Spring (rear brake camshaft)	7234	Stop (carb.shaft loose lever)	9614
Support (spare wheel & tire)	1418	Spring (second speed synchro.)	7234	Stop (hood catch latch)	16870
Support (steering column)	3519	Spring (service brake pedal)	2472	Stop (spare wheel)	1498
Support (sw. to strtr cable)	14548	Spring shackle kit	5630	Stop (spare wheel carrier)	1496
Support (throttle lever)	9774	Spring (shift fork)	4102	Strainer	9553
Support (wheel carrier)	1403-5	Spring (sliding clutch shaft)	4236	Strainer	9559
Support (wheel carr.stop bar)	1497	Spring (spare wheel lock)	18320	Strainer (hood)	16848-54
Support (w/s wing brkt.)	18284	Spring (spare wheel lock)	18356	Strainer (radiator grille)	8347
Support & brace (brkt. apron)	16100-01	Spring (spindle con.rod stud)	3309	Strap (brake rod)	2502
Support & grommet (cable)	4057				
Support & tie rod(headlamp)	13114	Spring (spndl.rod ball seat)	3327	Strap (emer.cable stabilizer)	2272
		Spring (starter brush)	11059	Strap (fuel tank support)	9051-68
Switch (back up lamp)	15520	Spring (starter drive)	11375	Strap (ign. coil mtg.)	12043
Switch (dome lamp)	13752	Spring (strtr. dr.anti-drift)	11369	Strap (master cylinder boot)	2186-87
Switch (head lamp dimmer)	13532	Spring (strtr. drive meshing)	11368	Strap (rear lamp guard)	13529
Switch (heater blower)	15122	Spring (steering column brg.)	3520	Strip (glass retainer)	17783
Switch (horn button)	3671	Spring (strg.& ing.lock ball)	3741	Strip (spring cover)	5508
Switch (hot air htr. blower)	13740	Spring (stop light switch)	13515	Stud (battery support)	5154
Switch (hyd. pump motor)	14515	Spring (tank filler lid)	16377	Stud (brake operating lever)	2106
Switch (ignition)	3680	Spring (throttle stop screw)	9589	Stud (brake operating wedge)	2051
Switch (ignition)	11572-75				
Switch (instrument lamp)	13740	Spring (trans. gear washer)	7072	Stud (brake operating wedge)	2053
Switch (light control)	11654	Spring (trans. rev. plunger)	7219	Stud (brake oper. wedge)	2252
		Spring (vacuum cont. ball)	4093	Stud (brake wedge)	2223
Switch (lighting & wiring)	11652-53	Spring (vac.control lever)	4066	Stud (bumper arm)	17766
Switch (road lamp)	15224	Spring (valve)	6513	Stud (bumper arm)	17767
Switch (spotlight)	15332	Spring (valve tappet)	6550	Stud Chart- Page 742	
Switch (starter-assy.)	11450	Spring (vane check)	9542	Stud (crankshaft brg. cap)	6345
Switch (starter push button)	11500	Spring (water pump)	8560	Stud (cross tube)	17766
Switch (stop light)	13480	Spring (wheel cover lock)	18346	Stud (cylinder head)	6065-67
Switch & wiring (ft.lighting)	11653	Spring (wheel cyl.piston ret)	2204-05	Stud (drag link ball)	3311
Swivel (choke lever)	9555	Spring (w/s wiper)	17533	Stud (fuel pump)	6515
Swivel (sliding clutch)	4158				
Swivel (stabilizer)	3533-34	Spring (w/s wiper arm ret.)	17531	Stud (hand brake link)	2837
Swivel (w/s wiper)	17584	Standard Parts (by size)-		Stud (muffler pipe to man.)	9454
Synchronizer (transmission)	7124	Page 676		Stud (oil filter)	18661
		Starter assy.	11002	Stud (oil pump filler)	6606
		Starter Chart- Page 494		Stud (outside mirror)	18432
		Starter drive	11350	Stud (shock absorber ball)	4024
		Starter Drive Chart-Page 497		Stud (spare wheel carrier)	1449
		Starter Drive Repl. Chart-		Stud (spindle arm ball)	3284
		Page 496		Stud (spindle conn.rod bolt)	3311
		Starter end plate	11050	Stud (spring shackle)	5463-65
		Starter end plate	11130	Stud (spring shackle)	5713-14
		Starter spring	11375	Stud (steering worm adj.)	3585
		Starter Repl.Chart-Page 493		Stud & washer (shock abs.)	18033
		Starter switch	11450	Stud & washer (shock abs.)	18152
		Steering chart	3524	Stud & washer(rear track bar)	4271
		Steering Shaft & Warm Chart-		Sun Visor	18652
		Page 94		Support (air cleaner)	9629
		Stem (brake adj. & spring)	2108	Support (battery)	5151
		Stem (brake shoe adj.)	2038	Support (battery)	10732
		Stem (choke plate valve)	9593	Support (batt. to sw. cable)	14550
		Stem (w/s wiper control)	17534-35	Support (brake cable front)	2623
		Stem & stuffing box(metering)	9525	Support (brake conduit)	2501
"T" (w/s washer)	17615				
"T" (w/s wiper tube)	17489				
Tag (motor type)	8259				
Tail lamp	13402-07				
Tank (fuel)	9002				
Tank (radiator lower)	8079				
Tank (w/s wiper vac.)	17640				
Tappet (valve)	6500				
Tee (oil gauge)	6073				
Tee (oil gauge)	18669				
Tee (w/s washer hose)	17587				
Terminal (battery cable)	14452				

T

CHASSIS PARTS CATALOGUE

Alphabetical Index

Part Name	Basic Part No.	Part Name	Basic Part No.	Part Name	Basic Part No.
Valve chamber cover gasket	6521	Washer (clutch equal. shaft)	7539	Washer (hd. lp. plug spacer)	14601
Valve (exhaust control)	9460	Washer (clutch pedal shaft)	7512	Washer (hub grease retainer)	1195
Valve (exhaust & intake)	6505	Washer (clutch pilot brg.)	7608	Washer (instrument cluster)	10857
Valve (fuel pump)	9358	Washer (Clutch plate)	4147	Washer (lighting switch)	11672
Valve (gasoline)	9189	Washer (cont. dash insulator)	9720	Washer (main jet)	9537
Valve job gaskets	6079	Washer (control rod sleeve)	9757	Washer(muffler brkt.grommet)	5272
Valve (hot air htr. adapter)	15136	Washer (coupling shaft)	4817	Washer (muffler pipe brkt.)	5284
Valve (hot air htr. defrost.)	18492	Washer (coupling shaft)	4818	Washer(oil filter ret. stud)	18642
Valve (hot water heater)	15142	Washer (coupling shaft hsg.)	4814	Washer (pin. brg. nut lock)	4636
Valve (hot water heater)	15199	Washer (cplg.shaft thrust)	4827	Washer (pinion brg. thrust)	4637
Valve (hot water heater)	18495				
Valve (intake)	6507	Washer (c/shaft ratchet)	6332	Washer (power take off shaft)	7256-57
Valve (master cylinder)	2178	Washer (cyl. head outlet)	8580	Washer (rad. core to dash)	8370
Valve spring	6513	Washer (diff. axle gear)	4059	Washer (radiator mounting)	8440
Valve tappet	6500	Washer(diff.axle gear thrust)	4228	Washer (radiator to dash rod)	5284
Valve (univ.jt.spider relief)	7075	Washer (diff.pin.gear thrust)	4230	Washer (rear axle insulator)	5784
Vane	9549	Washer (dist.brkr. plate adj)	12174	Washer (rear axle lock nuts)	4245
Vanity Mirror	18208	Washer (dist. cam retainer)	12179	Washer (road lamp)	15211
Vent (transmission case)	7034	Washer (dist.primary ferrule)	12157	Washer (road lamp bracket)	15232
Venturi (carburetor main)	9586	Washer (dist. primary term.)	12234	Washer (shift cam thrust)	7287
Visor (sun)	18236	Washer (drag link end)	3332	Washer (shift lever latch)	7226
Visor (sun)	18652				
W		Washer (drag link retainer)	3336	Washer (shift tube fulcrum)	7242
Warning & Clearance Lamp	18702	Washer (dr. pin. brg. thrust)	4667	Washer (shock absorber)	18039-40
Warning lamp	18702	Washer (drive shaft brg. adj.)	4667	Washer (sliding clutch)	4072
Washer (accel. pump plunger)	9639	Washer (emer. lvr. anti-rattle)	2132	Washer (spare wheel clamp)	1428
Washer (accel. pump shaft)	9535	Washer (eng. front support)	7249	Washer (speedo. gear thrust)	17287-90
Washer (adj. screw lock)	3564	Washer (engine mount bolt)	6033	Washer (spindle bolt dust)	3125
Washer (air shutter shaft)	9647	Washer (engine support)	6029	Washer (spotlight)	15232
Washer (back up lamp)	15523	Washer (engine support)	6033	Washer (spring shackle bolt)	5786
Washer (back up lamp)	15526	Washer (fan blade)	8628	Washer (spring shackle stud)	5466
Washer (battery cover)	10664-65	Washer (field term. insul.)	11093	Washer (stabilizer swivel)	3557
Washer (battery filler plug)	10721-22	Washer(fuel pump cover screw)	9357	Washer (starter armature)	11036
Washer (brg. spring)	10092				
Washer (bowl drain plug)	9591	Washer (fuel pump diaphragm)	9395	Washer (starter field term.)	11094
Washer (brake anchor pin)	2112	Washer (fuel pump oil seal)	9411	Washer (starter field term.)	11095
Washer (brake operating pin)	2112	Washer (fuel tank pipe)	9051	Washer (starter switch)	11106
Washer (brake operating stud)	2054	Washer (gas tube)	9524	Washer (strg. sector thrust)	3579
Washer (brake operating stud)	3557	Washer (gear shift lever)	7208	Washer (strg. worm thrust)	3562
Washer(brake pedal retr.spr.)	13514	Washer (gear shift lever)	7249	Washer (stop light switch)	13514
Washer (brake pedal shaft)	7512	Washer (gear shift lever)	7323	Washer (throttle lever)	9778
Washer (brush holder)	11073	Washer (gen. arm)	10113	Washer (tie rod end)	3332
Washer(carb.acc.pump plunger)	9639	Washer (generator bearing)	10121	Washer (trans. gear thrust)	7119
Washer (carburetor kicker)	9643	Washer (gen. bearing felt)	3125	Washer (trans. main shaft)	7062
Washer (carb.kicker spring)	9595	Washer (gen. bearing spring)	10087	Washer (trans. main shaft)	7071
Washer (carb. power jet)	9596				
Washer (choke lever)	9596	Washer (generator bracket)	7095	Washer (transmission shaft)	7069
		Washer (gen. end plate brg.)	10112	Washer (u/jt to trans shaft)	7095
		Washer (gen. end plate brg.)	10114	Washer (vac. cont. valve)	4064
		Washer (gen. end plate brg.)	10154	Washer (water pump impeller)	8513
		Washer (gen. end plate brg.)	10160-61	Washer (water pump thrust)	8513
		Washer (gen. end plate brg.)	10212	Washer (water pump thrust)	8554
		Washer (gen. end plate term.)	10208	Washer (wheel bearing nut)	1124
		Washer (gen. screw)	10117	Washer (wheel bearing thrust)	1184
		Washer (gen. terminal)	10106	Washer (windshield)	18293
		Washer (gen to vlv chmbr cvr)	10148	Washer (windshield wiper)	17541
		Washer (hand brake equalizer)	2091	Washer (windshield wiper)	17599

Abbreviations

abs.....absorber	dr.....drive	o/all.....overall
accel.....accelerator	eng.....engine	O.D.....outside diameter
adj.....adjusting	fdr.....fender	O/S.....over size
adpt.....adapter	flt.....flat	Pass.....passenger
alum.....aluminum	ft.....feet	pt.....point
amp.....ampere	frt.....front	qt.....quart
approx.....approximately	gal.....gallon	rad.....radiator
assy.....assembly	gen.....generator	reg.....regulator
brg.....bearing	hd.....head	repl.....replaced
brkt.....bracket	hex.....hexagon	reqd.....required
carb.....carburetor	hldr.....holder	ret.....retainer
chmbr.....chamber	H.P.....horse power	R.H.....right hand
C.O.E.....cab over engine	hsg.....housing	std.....standard
Comm.....commercial	hyd.....hydraulic	supt.....support
conn.....connecting	I.D.....inside diameter	tap.....tapping
con.....control	ign.....ignition	ten.....tension
C.P.....candle power	jt.....joint	term.....terminal
c/pin.....cotter pin	lbs.....pounds	thd.....thread
c/shaft.....crankshaft	L.H.....left hand	trans.....transmission
c/sunk.....countersunk	L.H.D.....left hand drive	u/joint.....universal joint
cvr.....cover	lt.....light	U/S.....under size
cyl.....cylinder	man.....manifold	vac.....vacuum
defl.....deflector	mldg.....moulding	vlv.....valve
dia.....diameter	mm.....millimeter	w/o.....without
diff.....differential	mtg.....mounting	w/pinion.....with pinion
dist.....distributor	no.....number	w/s.....windshield

