

1928-1929

FORD PASSENGER, COMMERCIAL AND TRUCK MODELS

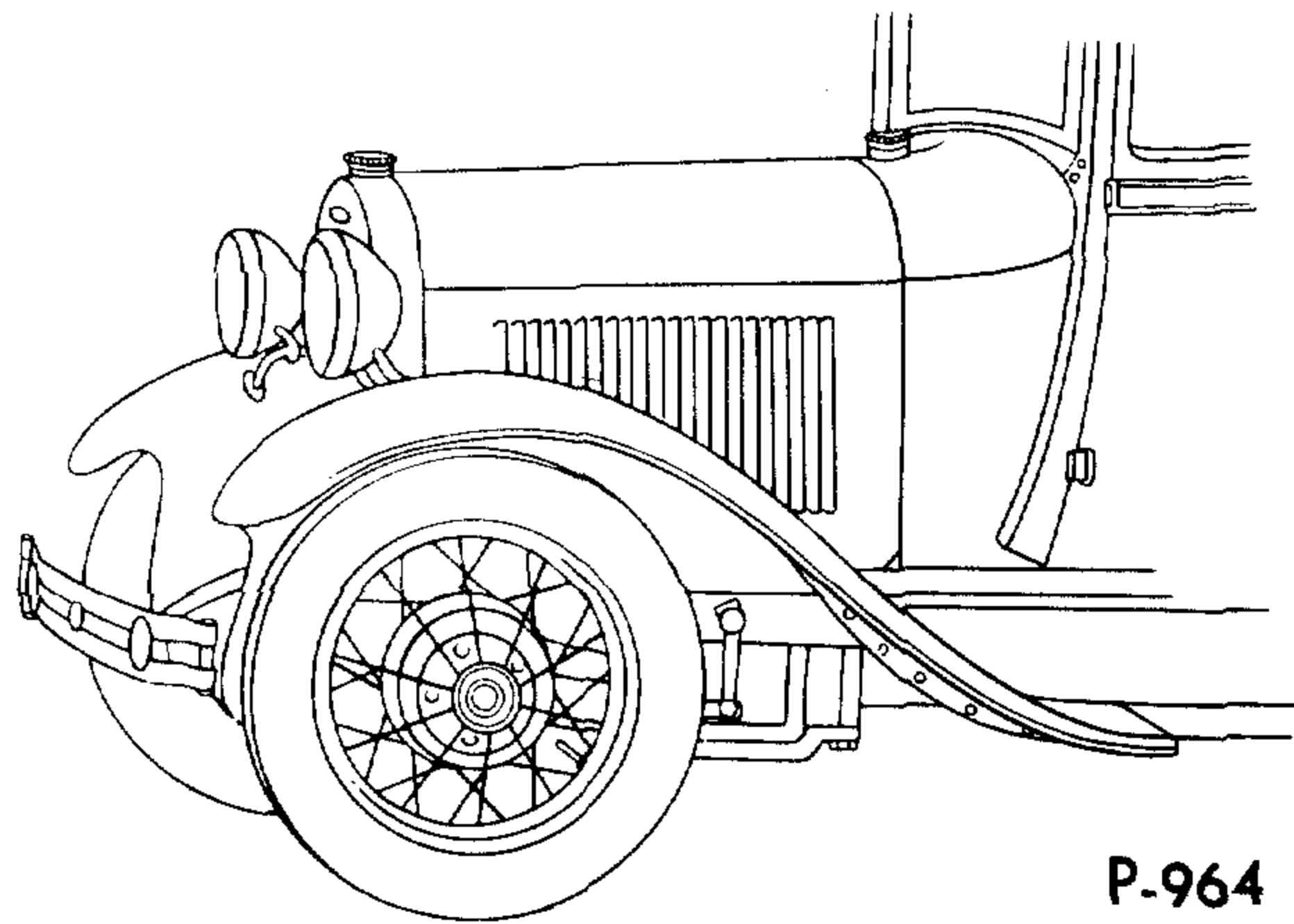
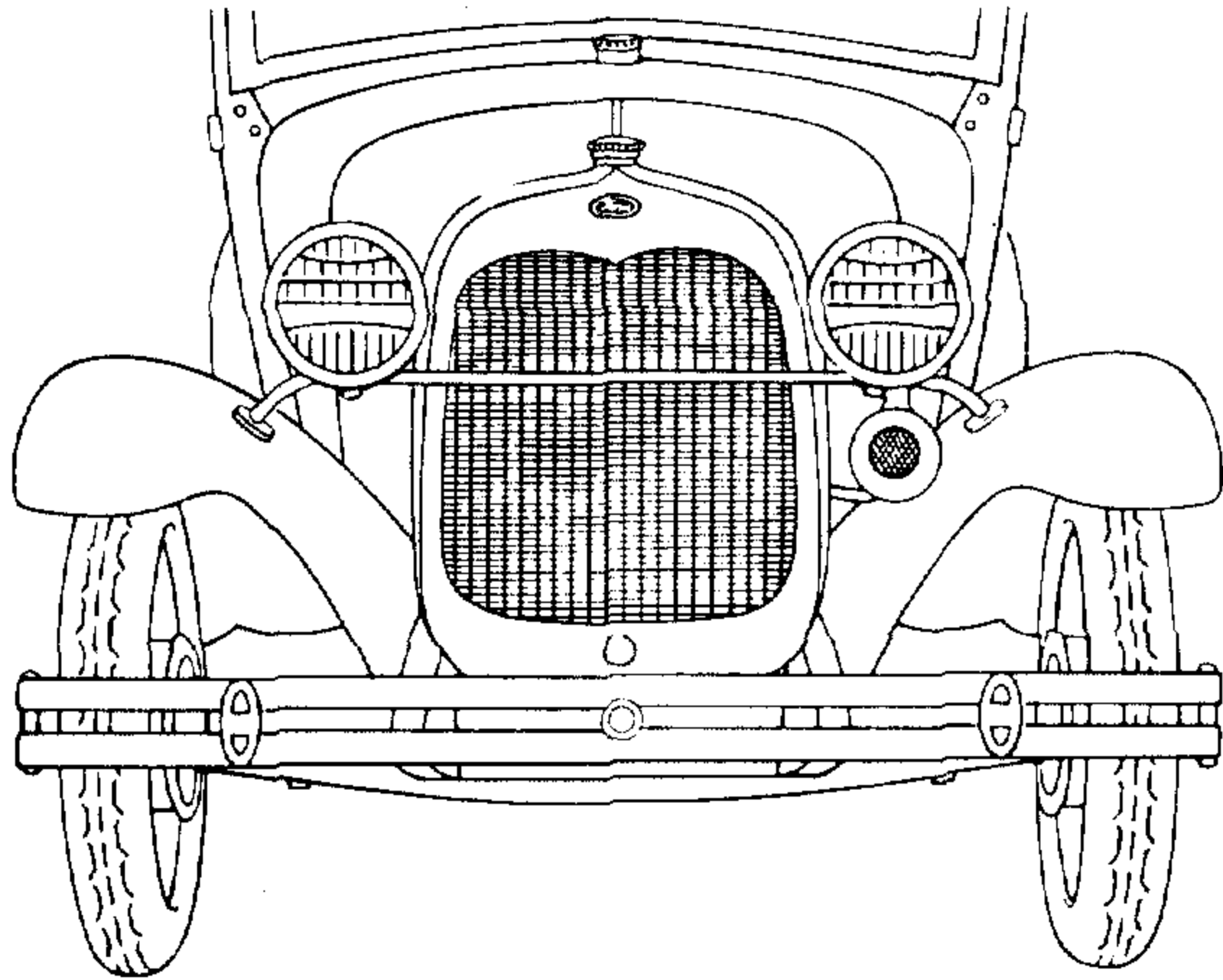

P-964

MODEL A FORD PASSENGER AND COMMERCIAL CARS—4 Cylinder Engine
(103½" Wheelbase)

MODEL AA FORD TRUCK—4 Cylinder Engine
(131½" Wheelbase)

BODY TYPE	NAME	YEAR	BODY TYPE	NAME	YEAR
PASSENGER					
35-A	Phaeton (Std.)	1928-29	60-C	Fordor Sedan (steel back) (Briggs)	1929
40-A	Roadster (Std.)	1928-29	68-A	Cabriolet	1929
45-A	Coupe (Std.)	1928-29	140-A	Town Car	1928-29
49-A	Coupe (Special)	1928-29	150-A	Station Wagon	1928-29
50-A	Coupe (Sport)	1928-29	155-A	Town Sedan (Murray)	1929
54-A	Coupe (Business)	1928-29	155-B	Town Sedan (Briggs)	1929
55-A	Tudor Sedan	1928-29	165-A	Fordor Sedan (Std.) (Murray)	1929
60-A	Fordor Sedan (leather back—seal brown top) (Briggs)	1928-29	165-B	Fordor Sedan (Std.) (Briggs)	1929
60-B	Fordor Sedan (leather back—black top) (Briggs)	1929	170-A	Fordor Sedan (Std.) (2 Window)	1929
			170-B	Fordor Sedan (Std.) (2 Window)	1929
COMMERCIAL AND TRUCKS					
76-A	Cab (Open)	1928-29	88-A	Platform	1928-29
78-A	Pickup	1928-29	89-A	Express	1928-29
79-A	Panel Delivery (103½" Wheelbase)	1928-29	130-A	De Luxe Delivery	1928-29
82-A	Cab (Closed)	1928-29	135-A	Taxicab	1928-29
85-A	Panel Delivery (131½" Wheelbase)	1928-29	188-A	Stake (131½" Wheelbase)	1928-29

1930

FORD PASSENGER, COMMERCIAL AND TRUCK MODELS

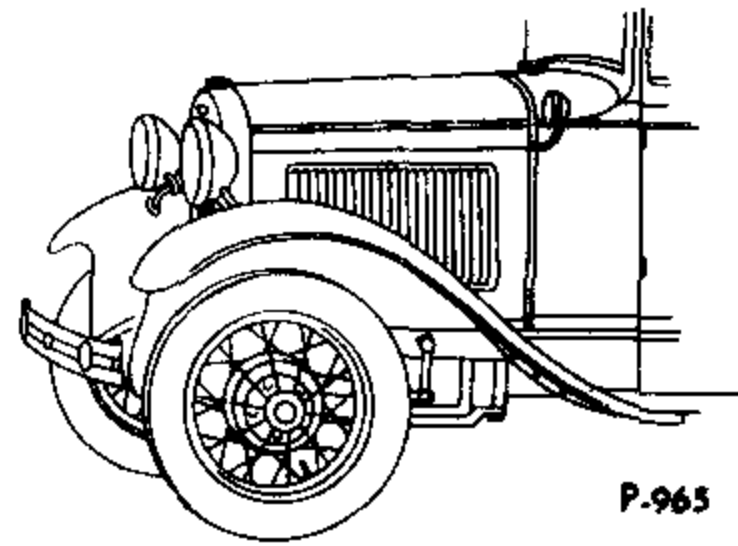
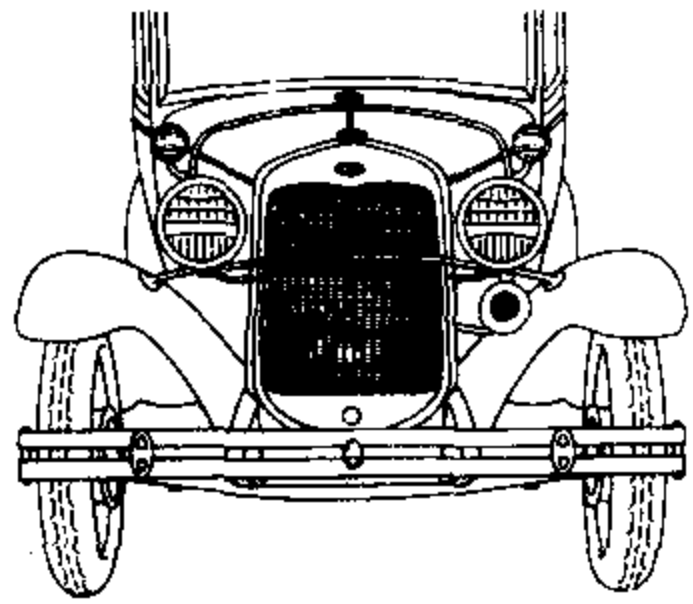

P.965

MODEL A FORD PASSENGER CAR
4 Cylinder Engine (103½" Wheelbase)

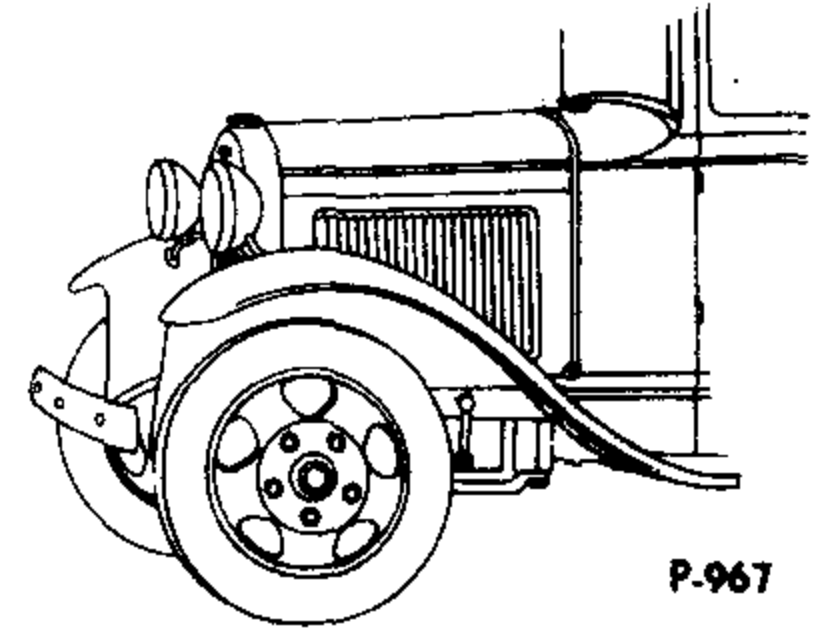
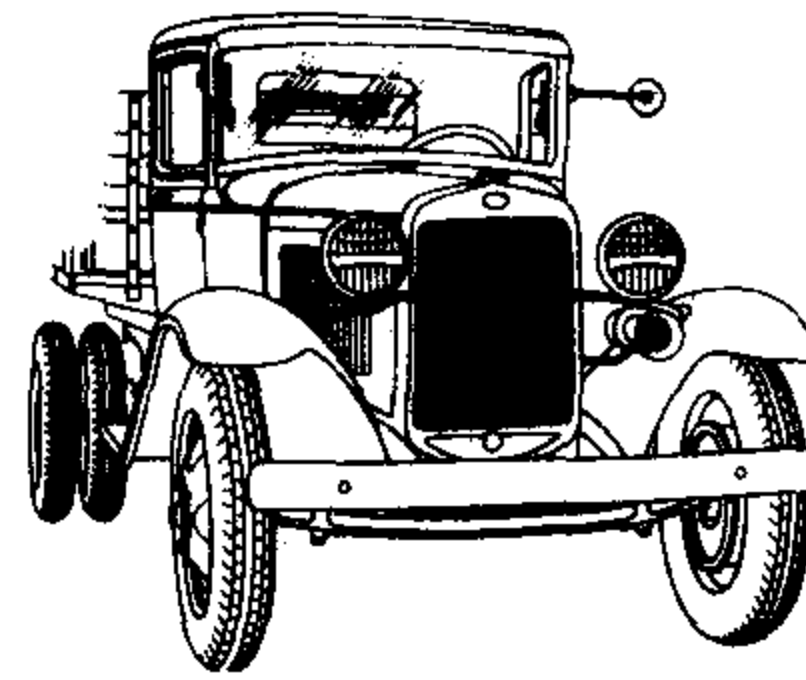

P.967

MODEL AA FORD TRUCK
4 Cylinder Engine (131½" and 157" Wheelbase)

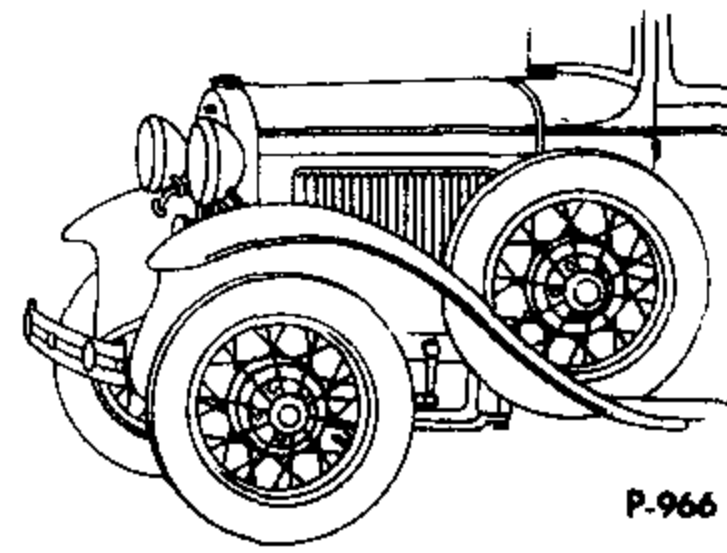
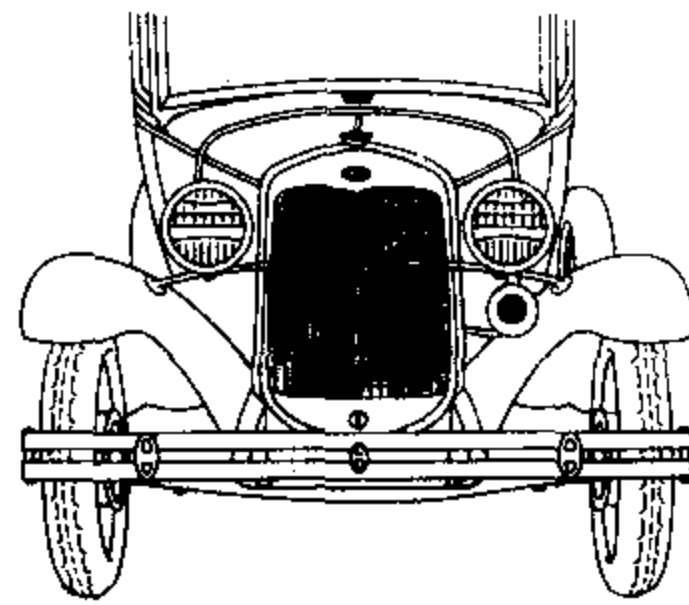

P.966

MODEL A FORD COMMERCIAL—4 Cylinder Engine
(103½" Wheelbase)

BODY TYPE	NAME	BODY TYPE	NAME
PASSENGER			
35-B	Phaeton (Standard)	155-C	Town Sedan (Murray)
40-B	Roadster (Standard)	155-D	Town Sedan (Briggs)
40-B	Roadster (De Luxe)	165-C	Fordor Sedan (Standard) (Murray)
45-B	Coupe (Standard)	165-D	Fordor Sedan (Standard) (Briggs)
45-B	Coupe (De Luxe)	170-B	Fordor Sedan (Standard) (2 Window)
50-B	Coupe (Sport)	170-B	Fordor Sedan (De Luxe) (2 Window)
55-B	Tudor Sedan	180-A	Phaeton (De Luxe)
68-B	Cabriolet	190-A	Victoria
COMMERCIAL AND TRUCK			
76-A	Cab (Open)	202-A	Gravity dump body assembly (Anthony)
76-B	Cab (Open)	203-A	Garbage body with heavy hydraulic hoist (2 cu. yd. capacity) (Galion)
78-A	Pickup	203-B	Garbage body with heavy hydraulic hoist (2 cu. yd. capacity) (Wood)
79-A	"A" Panel Delivery	203-C	Garbage body with heavy hydraulic hoist (3 cu. yd. capacity) (Galion)
79-B	"A" Panel Delivery	203-D	Garbage body with heavy hydraulic hoist (3 cu. yd. capacity) (Wood)
82-A	Cab (Closed)	204-A	Dump body with light hydraulic hoist (1½ cu. yd. capacity) (Galion)
82-B	Cab (Closed)	204-B	Dump body with light hydraulic hoist (1½ cu. yd. capacity) (Wood)
85-A	"A" Panel Delivery	205-A	Hi-Lift Hydraulic Coal Body (72 cu. ft.) (Wood)
85-B	"AA" Panel Delivery	206-A	Dump body with Rotary power hoist (Anthony)
88-A	Platform	207-B	Combined dump and coal body with high sides and end gate with chute opening and swinging partition with heavy hydraulic hoist (1½ cu. yd. capacity) (120 cu. ft. with top boards)
89-A	Express	208-A	Dump body with heavy hydraulic hoist (1½ cu. yd. capacity) (Galion)
130-A	De Luxe Delivery	208-B	Dump body with heavy hydraulic hoist (1½ cu. yd. capacity) (Wood)
130-B	De Luxe Delivery (drop floor)	225-A	"A" Panel Delivery (with drop floor)
130-B	De Luxe Delivery (Standard)	236-A	Light hydraulic hoist and body understructure (Galion)
150-B	Station Wagon	237-A	Heavy hydraulic hoist and body understructure (Galion)
185-A	Platform (157" Wheelbase)		
186-A	Stake (157" Wheelbase)		
188-A	Stake (131½" Wheelbase)		
200-A	Hand hoist dump body assembly (Anthony)		
201-A	Coal body, with heavy hydraulic hoist and end gate with chute (less swinging partition) (75 cu. ft.) (Galion)		
201-B	Coal body with heavy duty hydraulic hoist, swinging partition and end gate with chute (high end) (75 cu. ft. or 120 cu. ft. with sides) (Wood)		
201-C	Coal body with heavy duty hydraulic hoist and end gate with chute (less swinging partition) (75 cu. ft.) (Wood)		

1931

FORD PASSENGER CAR MODELS

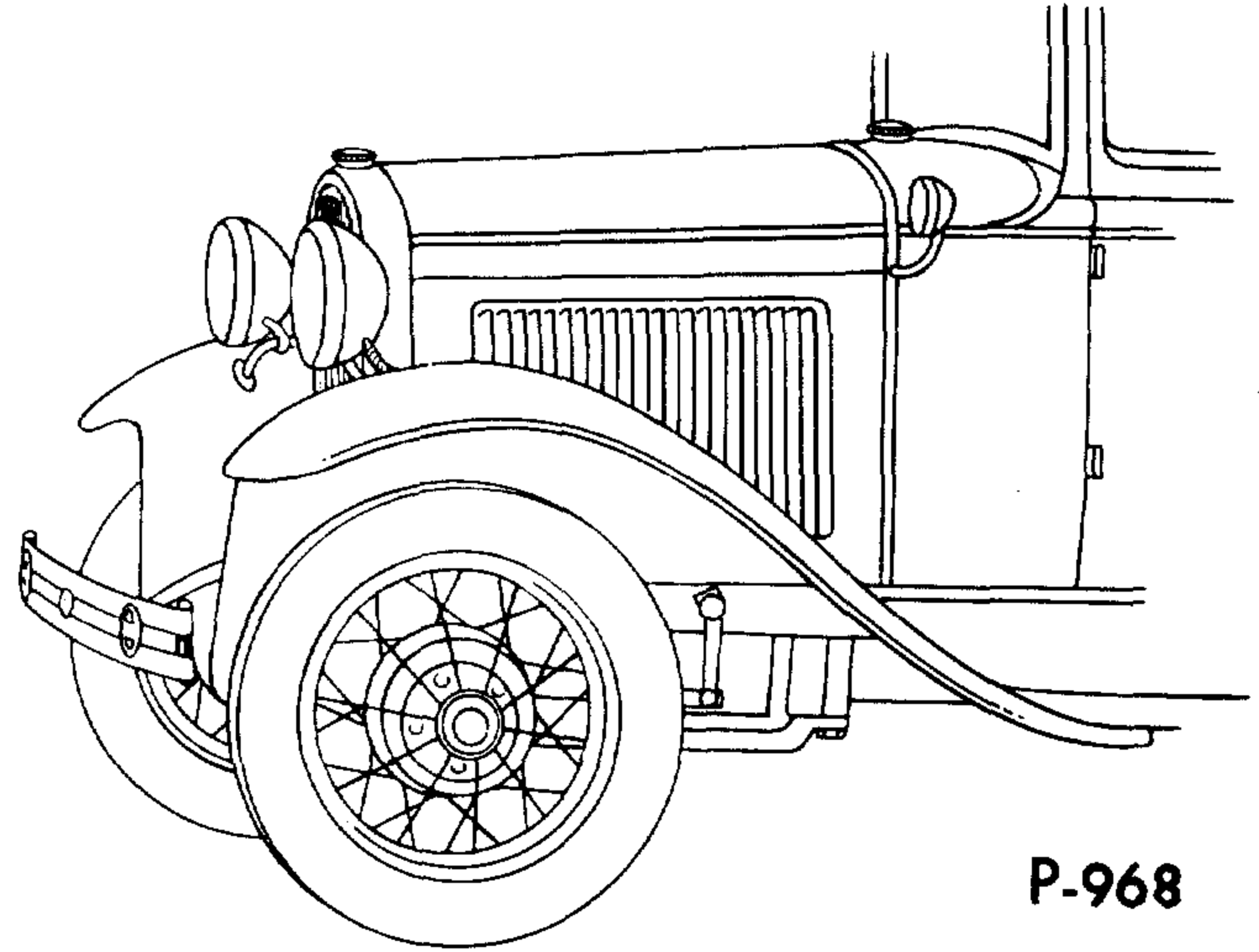
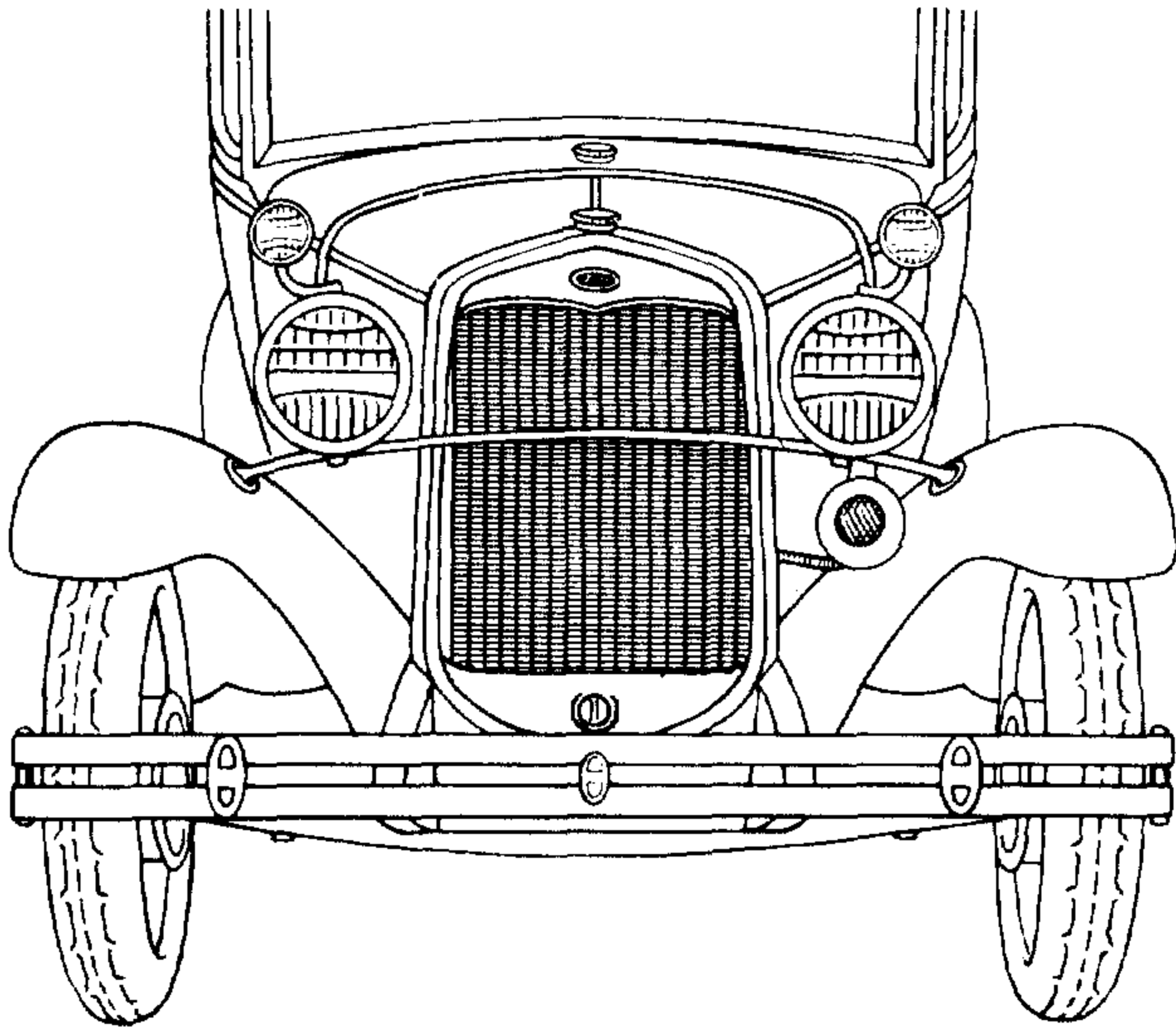

P-968

MODEL A FORD PASSENGER CAR—4 Cylinder Engine
(103½" Wheelbase)

BODY TYPE	NAME	BODY TYPE	NAME
35-B	Phaeton (Standard)	155-C	Town Sedan (Murray)
40-B	Roadster (Standard)	155-D	Town Sedan (Briggs)
40-B	Roadster (De Luxe)	160-A	Fordor Sedan (Standard)
45-B	Coupe (Standard)	160-B	Town Sedan
45-B	Coupe (De Luxe)	160-C	Fordor Sedan (De Luxe)
50-B	Coupe (Sport)	165-C	Fordor Sedan (Standard) (Murray)
55-B	Tudor Sedan	165-D	Fordor Sedan (Standard) (Briggs)
68-B	Cabriolet	170-B	Fordor Sedan (De Luxe) (2 Window)
68-C	Cabriolet	180-A	Phaeton (De Luxe)
		190-A	Victoria

1931

FORD COMMERCIAL AND TRUCK MODELS

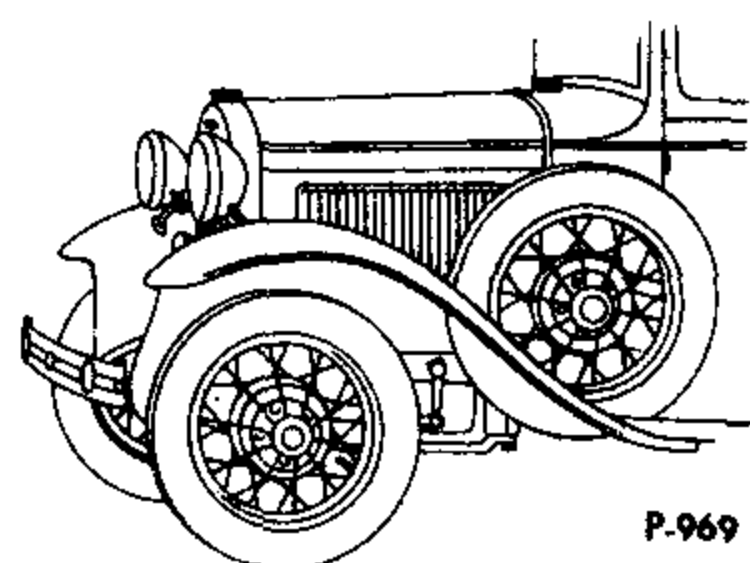
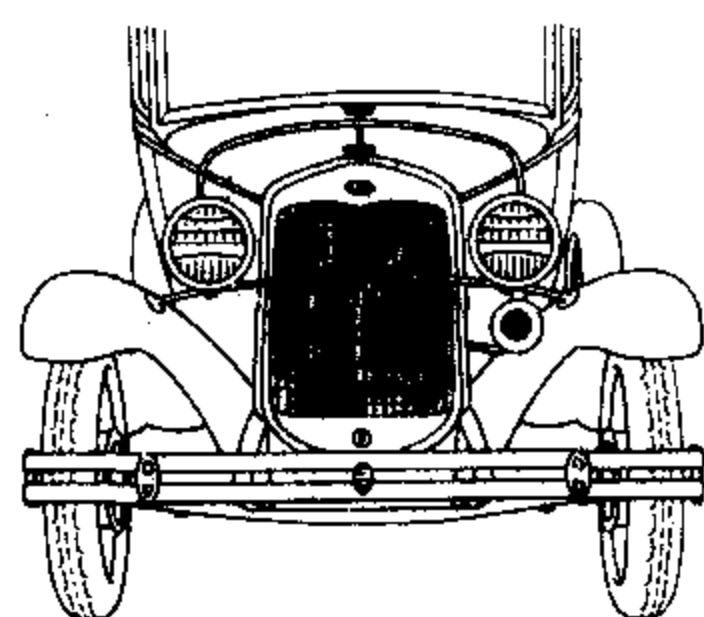

P-969

MODEL A FORD COMMERCIAL—4 Cylinder Engine
(103½" Wheelbase)

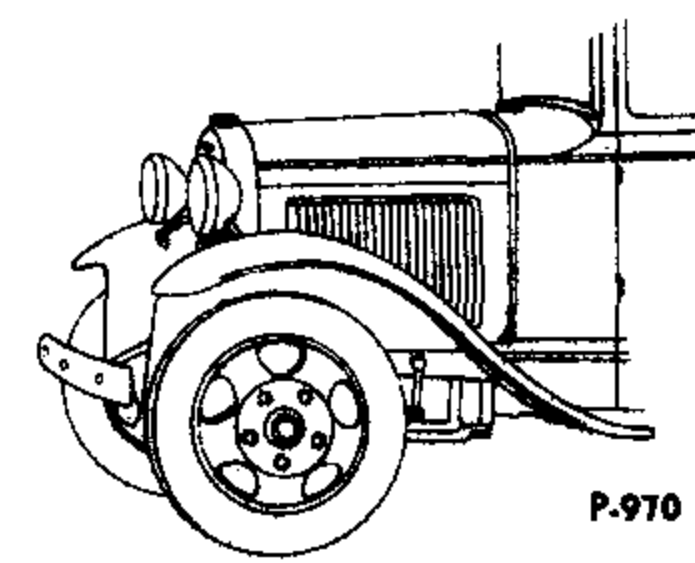
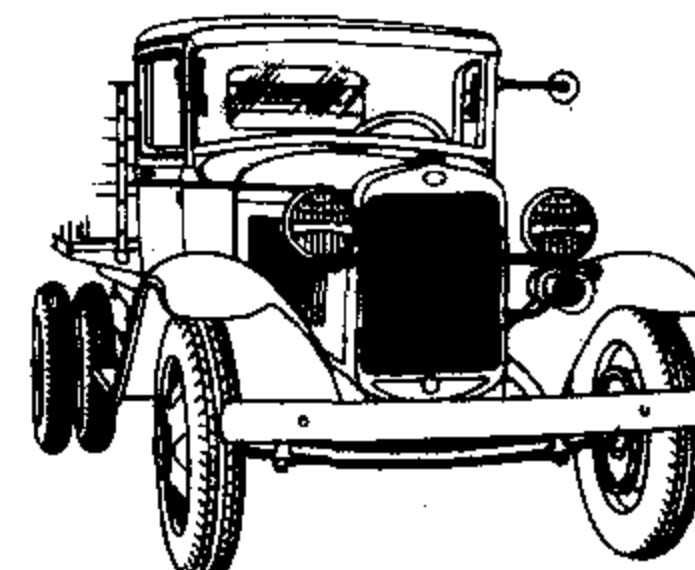

P-970

MODEL AA FORD TRUCK—4 Cylinder Engine
(131½" and 157" Wheelbase)

BODY TYPE	N A M E	BODY TYPE	N A M E
65-A	Canopy and Screens (Used with Type 78-B)	204-B	Dump body with light hydraulic hoist (1½ cu. yd. capacity) (Wood)
66-A	De Luxe Pickup	205-A	Hi-Lift Hydraulic Coal Body (72 cu. ft.) (Wood)
76-B	Cab (Open)	206-B	Dump body with mechanical hoist (1½ cu. yd. capacity) (Detwiller)
78-A	Pickup	207-B	Combined dump and coal body with high sides and end gate with chute opening and swinging partition (1½ cu. yd. capacity) (120 cu. ft. with top boards)
78-B	Pickup	208-A	Dump body with heavy hydraulic hoist (1½ cu. yd. capacity) (Galion)
79-A	Panel Delivery (103½" Wheelbase)	208-B	Dump body with heavy hydraulic hoist (1½ cu. yd. capacity) (Wood)
79-B	Panel Delivery (103½" Wheelbase)	210-A	"AA" Panel Delivery
82-B	Cab (Closed)	225-A	"A" Panel Delivery (with drop floor)
85-B	Panel Delivery (131½" Wheelbase)	228-A	Stock Racks
130-B	De Luxe Delivery (Drop Floor)	229-A	Service Car
130-B	De Luxe Delivery (Standard)	236-A	Light hydraulic hoist and body understructure (Galion)
150-B	Station Wagon	236-B	Light hydraulic hoist and body understructure
185-B	Platform (157" Wheelbase)	237-A	Heavy hydraulic hoist and body understructure (Galion)
186-B	Stake (157" Wheelbase)	237-B	Heavy hydraulic hoist and body understructure (Wood)
187-A	Platform (131½" Wheelbase)	238-A	Stock Racks (157" Wheelbase)
189-A	Stake (131½" Wheelbase)	239-A	Meat Packers Express
195-A	Express Body (131½" Wheelbase)	242-A	Heavy Duty Express Body (131½" Wheelbase)
196-A	Canopy Top and Screens (For 195-A)	244-A	Grain body with or without stock rack or grain side extensions (157" Wheelbase)
197-A	Express Body (157" Wheelbase)	248-A	Grain body with or without stock rack or grain side extensions (131½" Wheelbase)
198-A	Canopy Top and Screens (For 197-A)	255-A	Special Delivery (Natural Wood)
199-A	Ice Wagon	270-A	Funeral Service
200-B	Dump Body with hand hoist (1½ cu. yd. capacity) (Galion)	275-A	Funeral Coach
201-A	Coal body with heavy hydraulic hoist and end gate with chute (less swinging partition) (75 cu. ft.) (Galion)	280-A	Ambulance
201-B	Coal body with heavy duty hydraulic hoist, swinging partition and end gate with chute (high end) (75 cu. ft. or 120 cu. ft. with sides) (Wood)	285-A	Police, Patrol (De Luxe)
201-C	Coal body with heavy duty hydraulic hoist and end gate with chute (less swinging partition) (75 cu. ft.) (Wood)	290-A	Police Patrol (Standard)
202-B	Gravity dump body (1½ cu. yd. capacity) (Wood)	295-A	Town Car Delivery
203-A	Garbage body with heavy hydraulic hoist (2 cu. yd. capacity) (Galion)	300-A	De Luxe Delivery
203-B	Garbage body with heavy hydraulic hoist (2 cu. yd. capacity) (Wood)	315-A	Standrive
203-C	Garbage body with heavy hydraulic hoist (3 cu. yd. capacity) (Galion)	330-A	School and Passenger Bus
203-D	Garbage body with heavy hydraulic hoist (3 cu. yd. capacity) (Wood)	400-A	Convertible Sedan
204-A	Dump body with light hydraulic hoist (1½ cu. yd. capacity) (Galion)		

1932

FORD PASSENGER, COMMERCIAL AND TRUCK MODELS

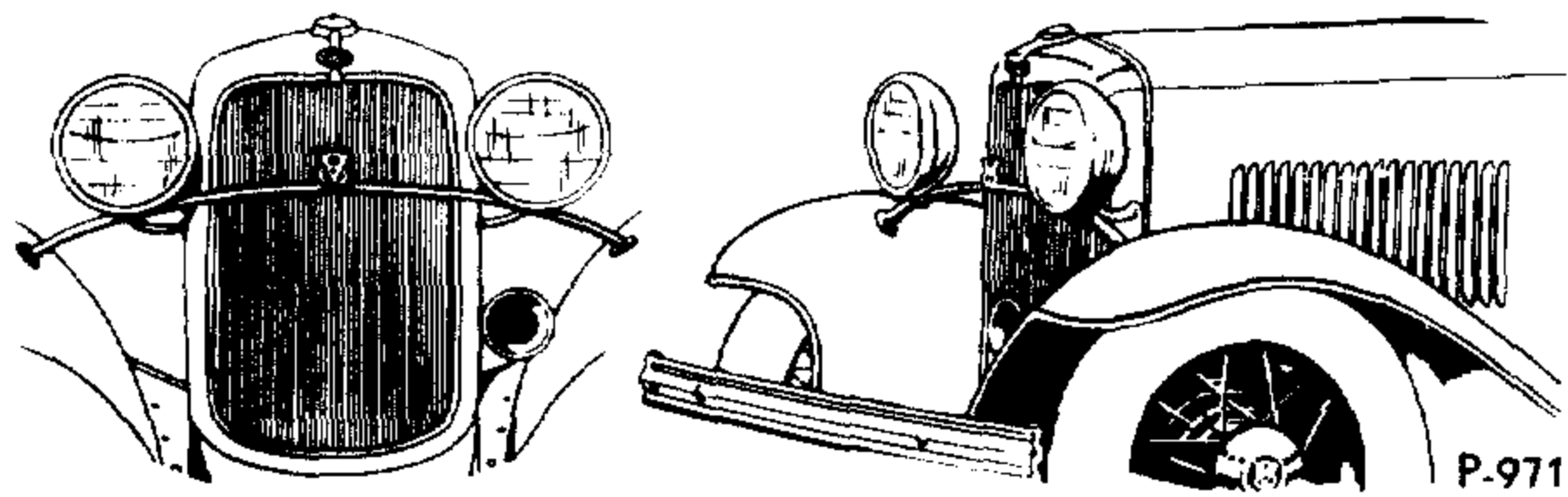

MODEL 18 FORD PASSENGER CAR
8 Cylinder Engine (106" Wheelbase)

MODEL B FORD PASSENGER CAR
4 Cylinder Engine (106" Wheelbase)

(Illustration is 8-Cylinder model; 4-Cylinder is the same excepting V-8 ornaments)

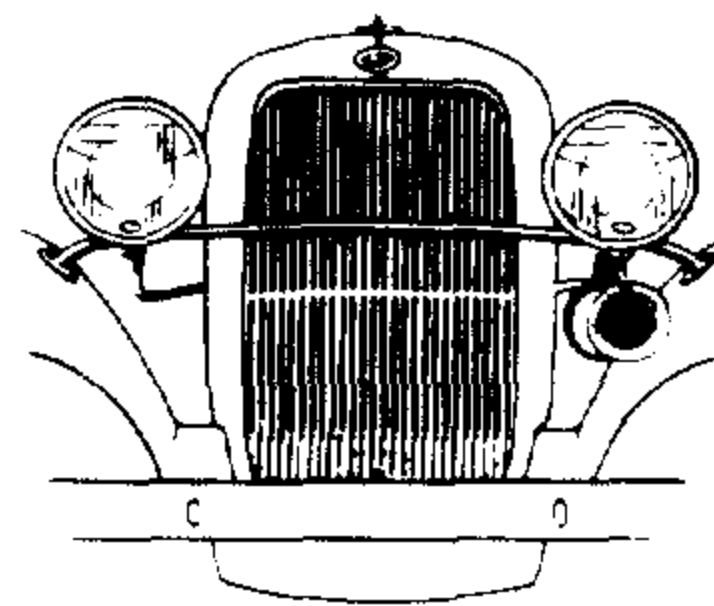

MODEL BB FORD TRUCK

8 Cylinder Engine (131½" and 157" Wheelbase)

4 Cylinder Engine (131½" and 157" Wheelbase)

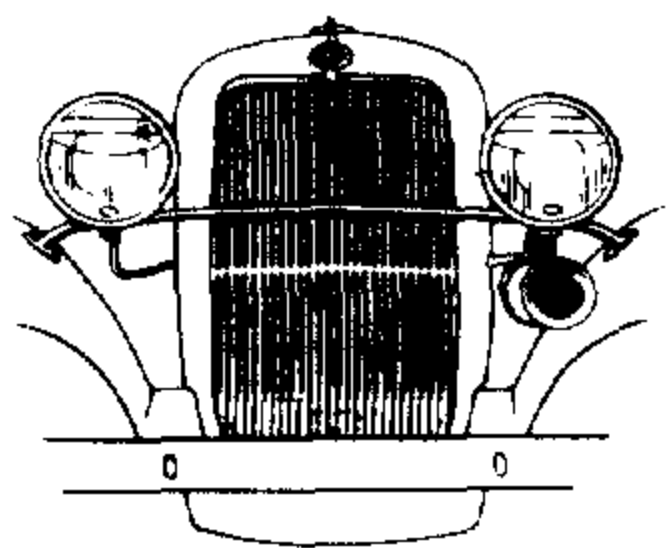

MODEL B FORD COMMERCIAL

8 Cylinder Engine—(106" Wheelbase)

4 Cylinder Engine—(106" Wheelbase)

(Illustration is 4-Cylinder model; 8-Cylinder is the same with V-8 ornaments)

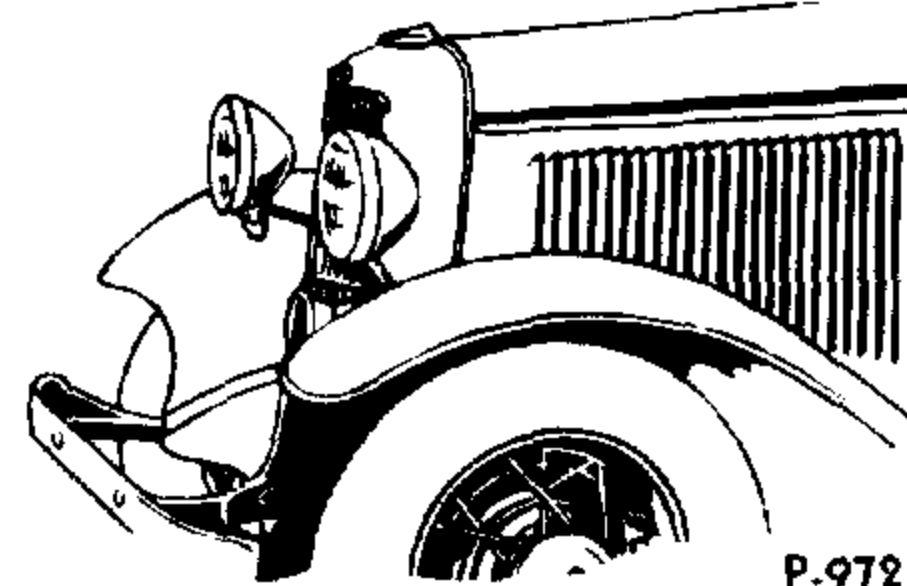

BODY TYPE	NAME	BODY TYPE	NAME
PASSENGER			
35	Phaeton (Standard)	55	Tudor Sedan (De Luxe)
35	Phaeton (De Luxe)	68	Cabriolet
40	Roadster (Standard)	160	Fordor Sedan (Standard)
40	Roadster (De Luxe)	160	Fordor Sedan (De Luxe)
45	Coupe (Standard)	190	Victoria
50	Coupe (Sport)	400	Convertible Sedan
55	Tudor Sedan (Standard)	520	Coupe (De Luxe)
COMMERCIAL AND TRUCK			
76	Open Cab	204-B	Dump body assembly—complete with hydraulic hoist—without body running board (1½ cu. yd. capacity) (Wood)
78	Pickup	206	Dump body with mechanical hoist (1½ cu. yd. capacity)
79	Panel Delivery (Standard) (106" Wheelbase)	208-A	Dump body assembly—complete with hydraulic hoist—without body running board (1½ cu. yd. capacity) (Galion)
79	Panel Delivery (De Luxe) (106" Wheelbase)	208-B	Dump body assembly—complete with hydraulic hoist—with body running board (1½ cu. yd. capacity) (Galion)
82	Closed Cab	210	Panel Delivery (157" Wheelbase)
85	Panel Delivery (Standard) (131½" Wheelbase)	228-A	Stock Racks
85	Panel Delivery (De Luxe) (131½" Wheelbase)	238-A	Stock Racks (157" Wheelbase)
150	Station Wagon	242-A	Heavy duty express body (131½" Wheelbase)
185-B	Platform (157" Wheelbase)	244-A	Grain body with or without stock rack or grain side extensions (157" Wheelbase)
186-B	Stake (157" Wheelbase)	248-A	Grain body with or without stock rack or grain side extensions (131½" Wheelbase)
187-A	Platform (131½" Wheelbase)	315-A	Standrive
189-A	Stake (131½" Wheelbase)	330-A	School and Passenger Bus
195	Express Body (131½" Wheelbase)	330	School and Passenger Bus
197	Express Body (157" Wheelbase)	410	Sedan Delivery
199-A	Ice Wagon		
200	Dump body assembly—complete with hand hoist (1½ cu. yd. capacity)		
202	Gravity dump body assembly—complete (1½ cu. yd. capacity)		
204-A	Dump body assembly—complete with hydraulic hoist—without body running board (1½ cu. yd. capacity) (Wood)		

1933

FORD PASSENGER, COMMERCIAL AND TRUCK MODELS

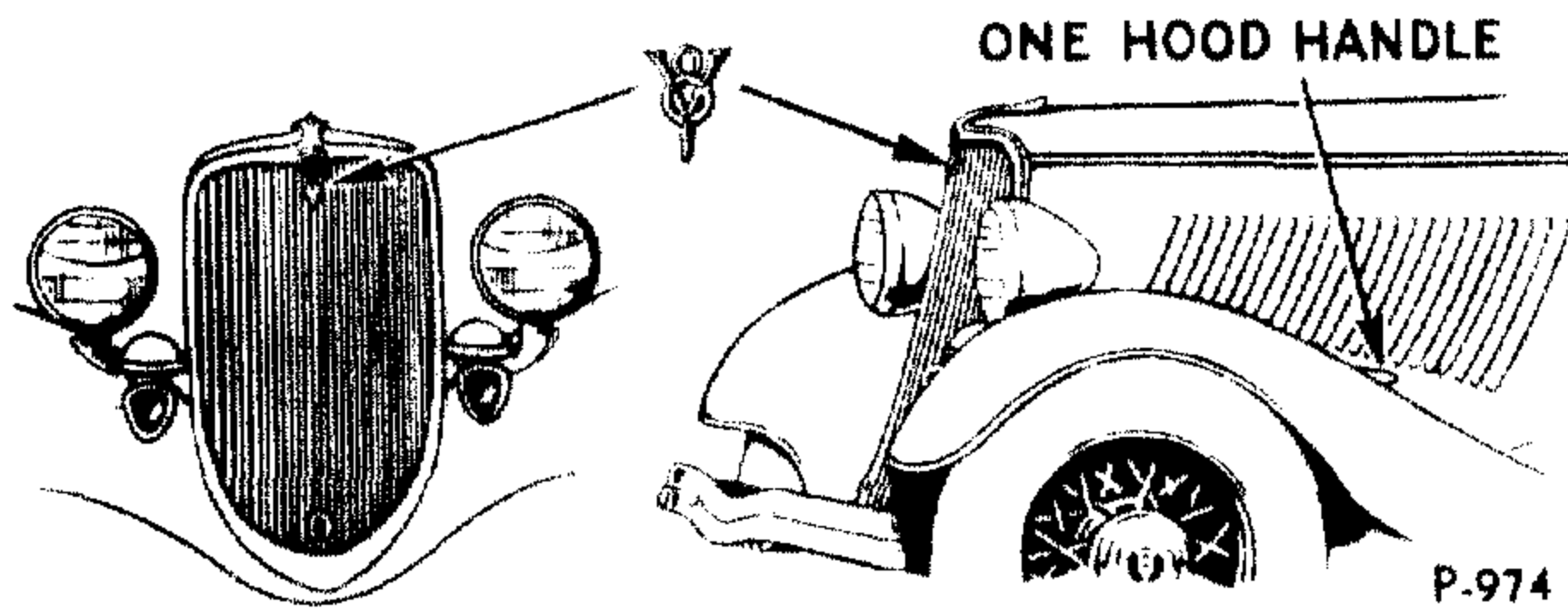

MODEL 40 FORD PASSENGER CAR
8 Cylinder Engine (112" Wheelbase)
4 Cylinder Engine (112" Wheelbase)
(Illustration is 8-Cylinder model; 4-Cylinder is the same excepting V-8 ornaments)

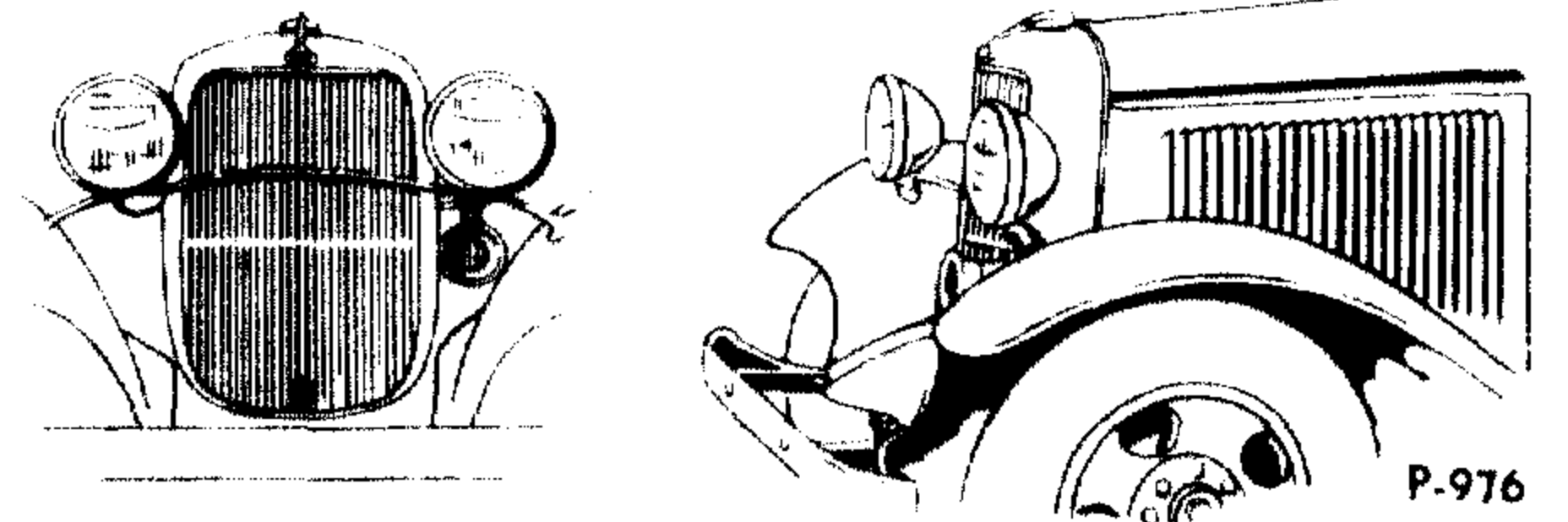

MODEL BB FORD TRUCK
8 Cylinder Engine (131½" and 157" Wheelbase)
4 Cylinder Engine (131½" and 157" Wheelbase)

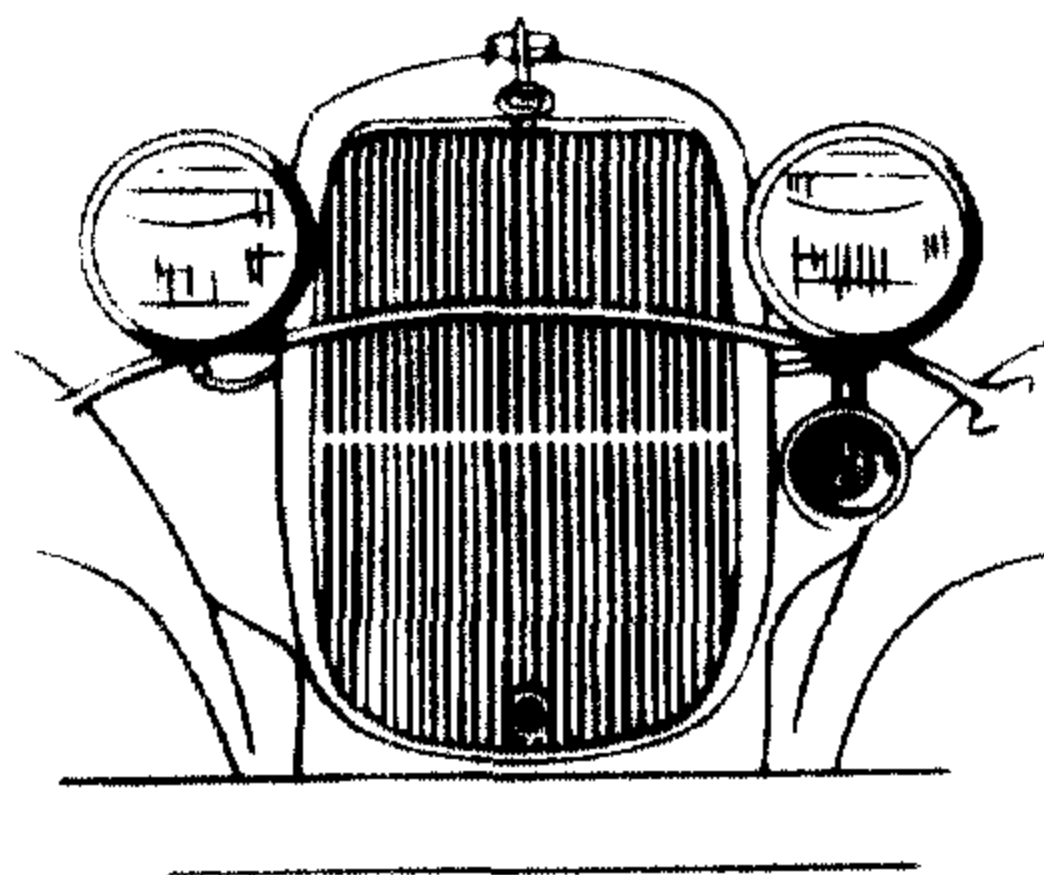

MODEL 46 FORD COMMERCIAL
8 Cylinder Engine (112" Wheelbase) **4 Cylinder Engine (112" Wheelbase)**

BODY TYPE	NAME	BODY TYPE	NAME
PASSENGER			
700	Tudor Sedan (Standard)	730	Fordor Sedan (De Luxe)
700	Tudor Sedan (De Luxe)	740	Victoria
710	Roadster (Standard)	750	Phaeton (Standard)
710	Roadster (De Luxe)	750	Phaeton (De Luxe)
720	Coupe (Standard) (3 Window)	760	Cabriolet
720	Coupe (De Luxe) (3 Window)	770	Coupe (Standard) (5 Window)
730	Fordor Sedan (Standard)	770	Coupe (De Luxe) (5 Window)
COMMERCIAL AND TRUCK			
85	Panel Delivery (Standard) (131½" Wheelbase)	810	Closed Cab (Specify BB or 46 Chassis)
85	Panel Delivery (De Luxe) (131½" Wheelbase)	820	Panel Delivery (Standard) (112" Wheelbase)
204-A	Dump body assembly—complete with hydraulic hoist—without running board (1½ cu. yd. capacity) (Wood)	820	Panel Delivery (De Luxe) (112" Wheelbase)
210	Panel Delivery (157" Wheelbase)	830	Pickup
800	Open Cab (Specify BB or 46 Chassis)	850	Sedan Delivery
		860	Station Wagon

1934

FORD PASSENGER, COMMERCIAL AND TRUCK MODELS

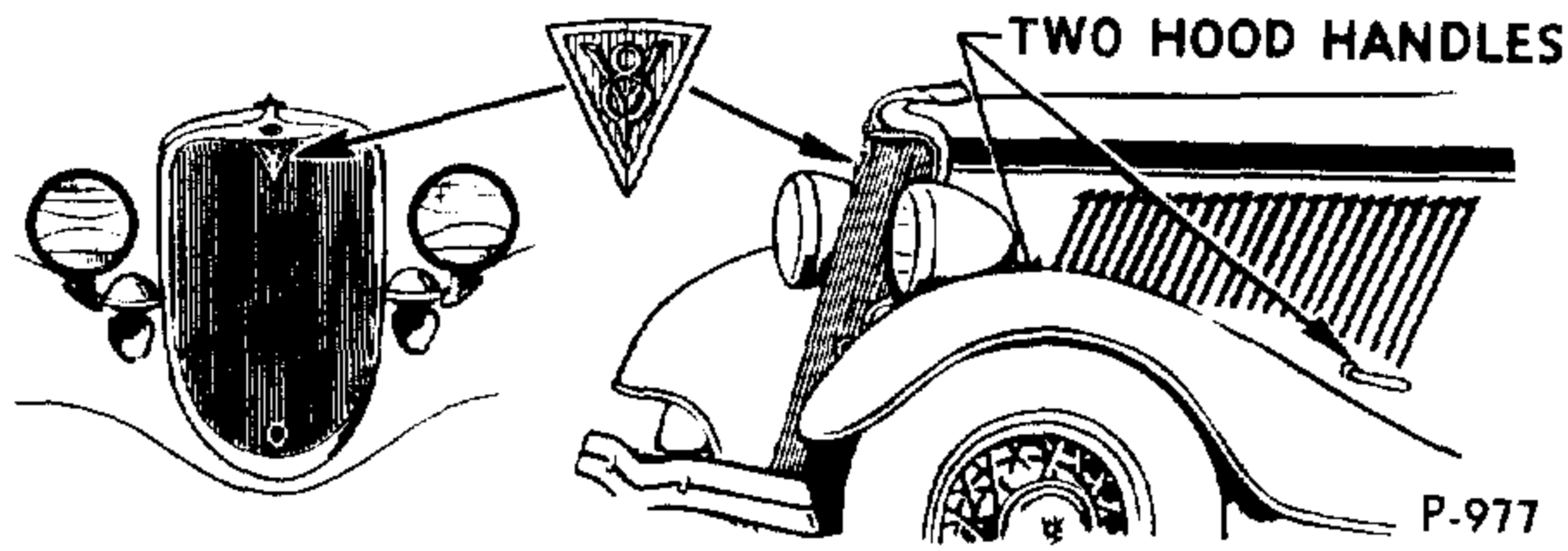

MODEL 40 FORD PASSENGER CAR
 8 Cylinder Engine (112" Wheelbase)
 4 Cylinder Engine (112" Wheelbase)

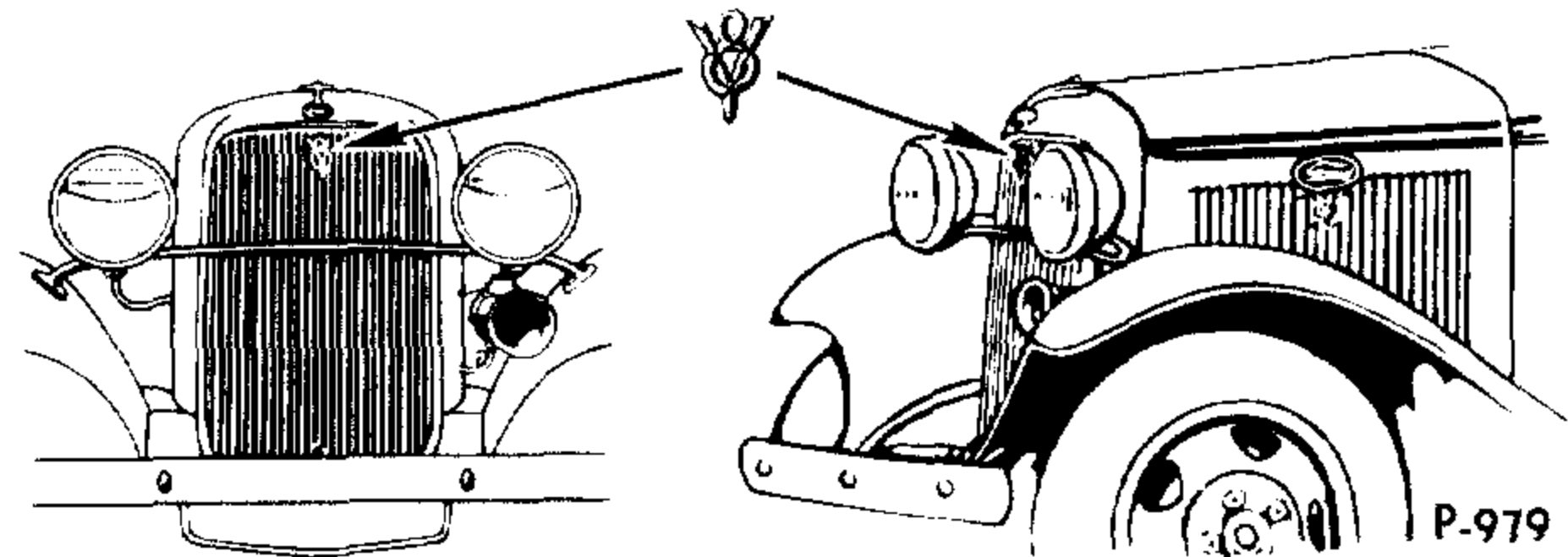

MODEL BB FORD TRUCK
 8 Cylinder Engine (131½" and 157" Wheelbase)
 4 Cylinder Engine (131½" and 157" Wheelbase)

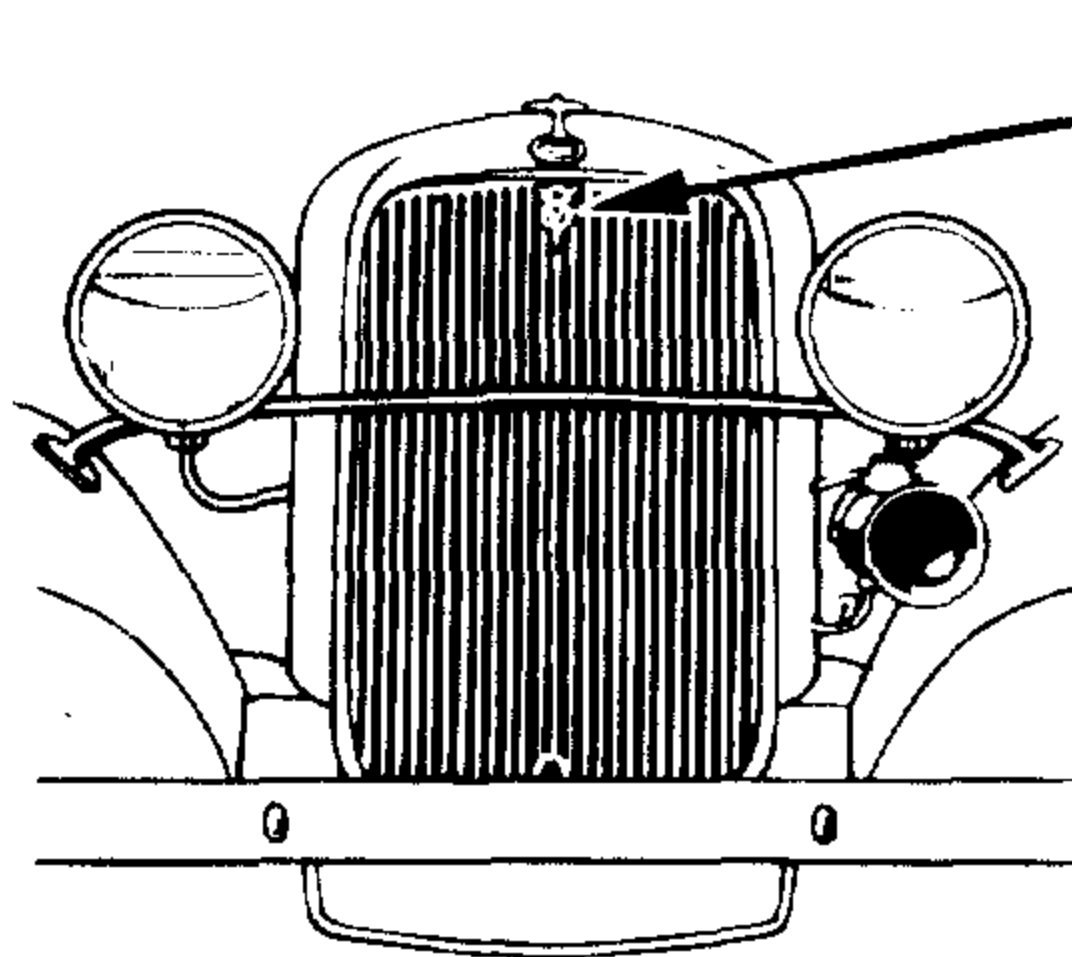

MODEL 46 FORD COMMERCIAL
 8 Cylinder Engine (112" Wheelbase)

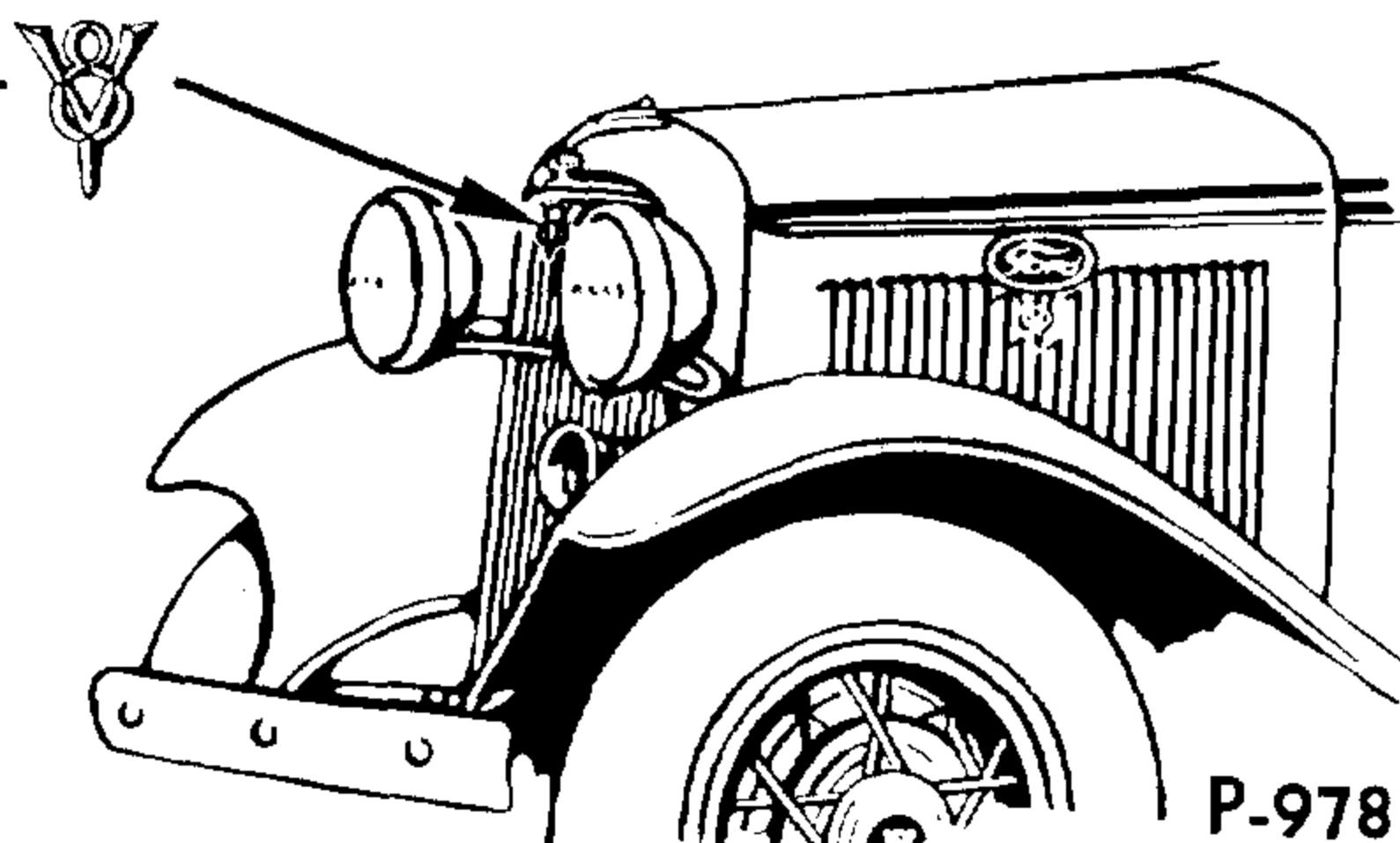

4 Cylinder Engine (112" Wheelbase)

BODY TYPE	NAME	BODY TYPE	NAME
PASSENGER			
700	Tudor Sedan (Standard)	730	Fordor Sedan (De Luxe)
700	Tudor Sedan (De Luxe)	740	Victoria
710	Roadster (De Luxe)	750	Phaeton (De Luxe)
720	Coupe (Standard) (3 Window)	760	Cabriolet
720	Coupe (De Luxe) (3 Window)	770	Coupe (Standard) (5 Window)
730	Fordor Sedan (Standard)	770	Coupe (De Luxe) (5 Window)
COMMERCIAL AND TRUCK			
85	Panel Delivery (Standard) (131½" Wheelbase)	810	Closed Cab (Specify BB or 46 Chassis)
85	Panel Delivery (De Luxe) (131½" Wheelbase)	820	Panel Delivery (Standard) (112" Wheelbase)
204-A	Dump body assembly—complete with hydraulic hoist —without running board (1½ cu. yd. capacity) (Wood)	820	Panel Delivery (De Luxe) (112" Wheelbase)
210	Panel Delivery (157" Wheelbase)	830	Pickup
800	Open Cab (Specify BB or 46 Chassis)	850	Sedan Delivery
		860	Station Wagon

1935

FORD PASSENGER, COMMERCIAL AND TRUCK MODELS

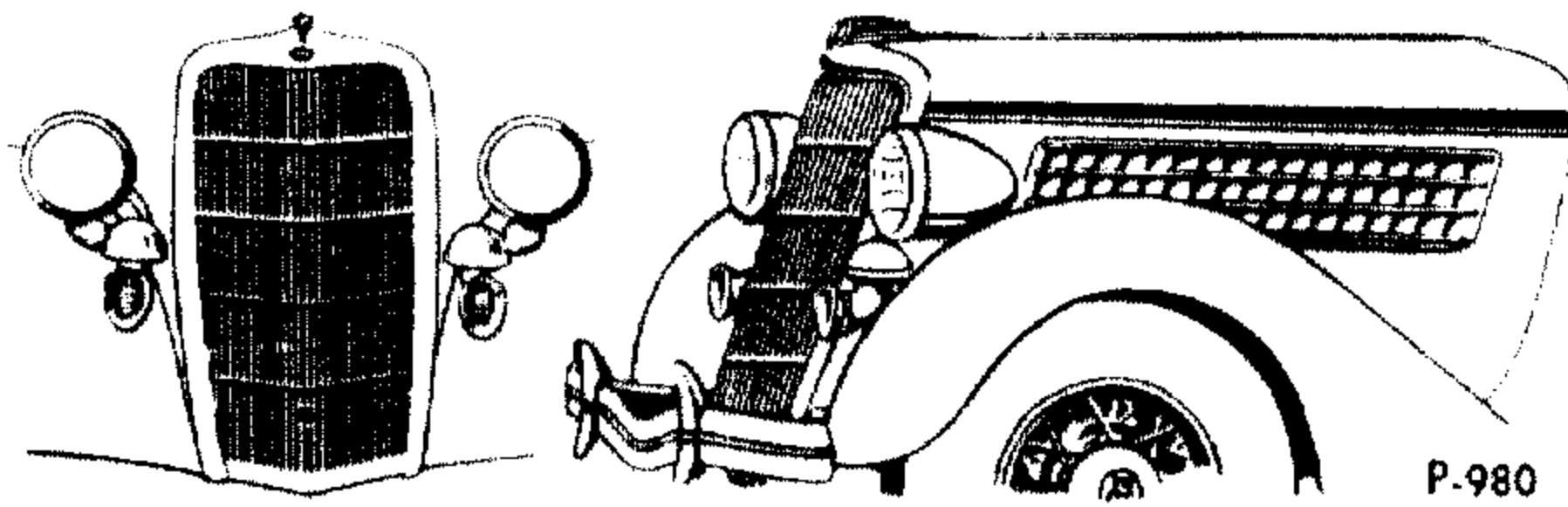

MODEL 48 FORD PASSENGER CAR
8 Cylinder Engine (112" Wheelbase)

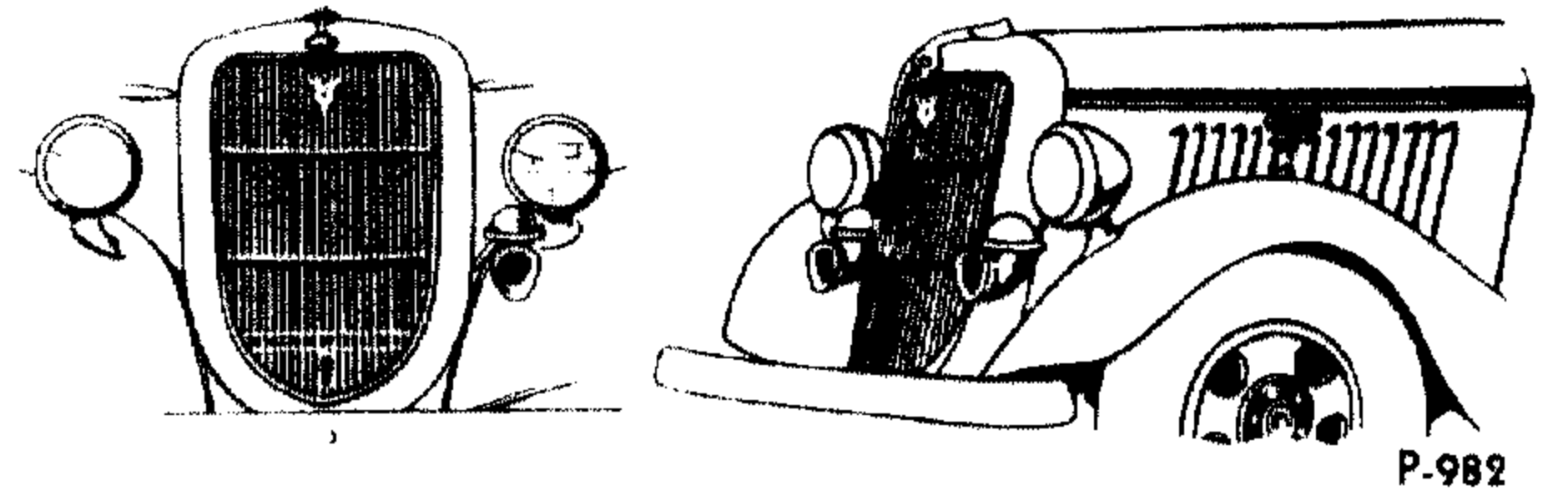

MODEL 51 FORD TRUCK
8 Cylinder Engine (131½" and 157" Wheelbase)

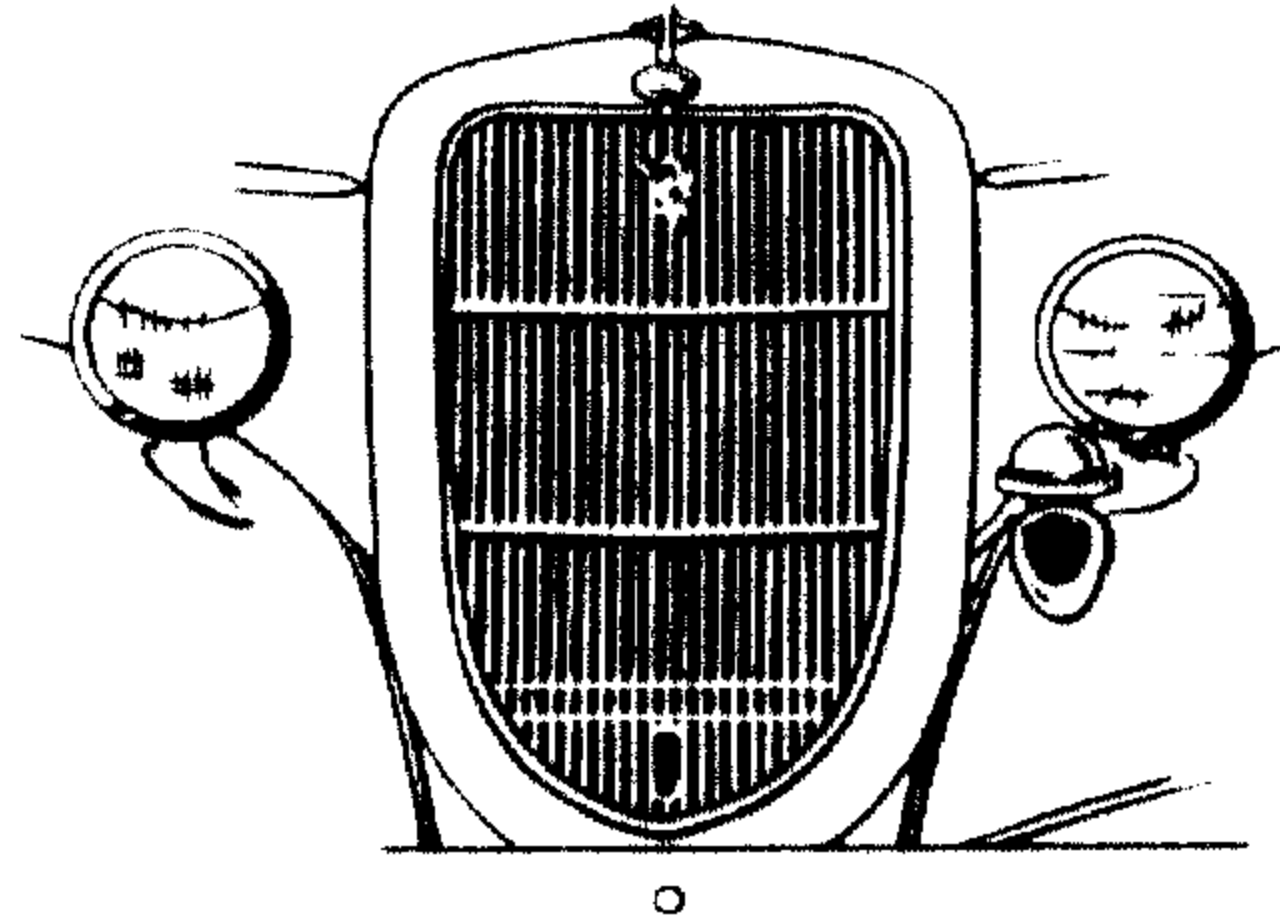

MODEL 50 FORD COMMERCIAL
8 Cylinder Engine (112" Wheelbase)

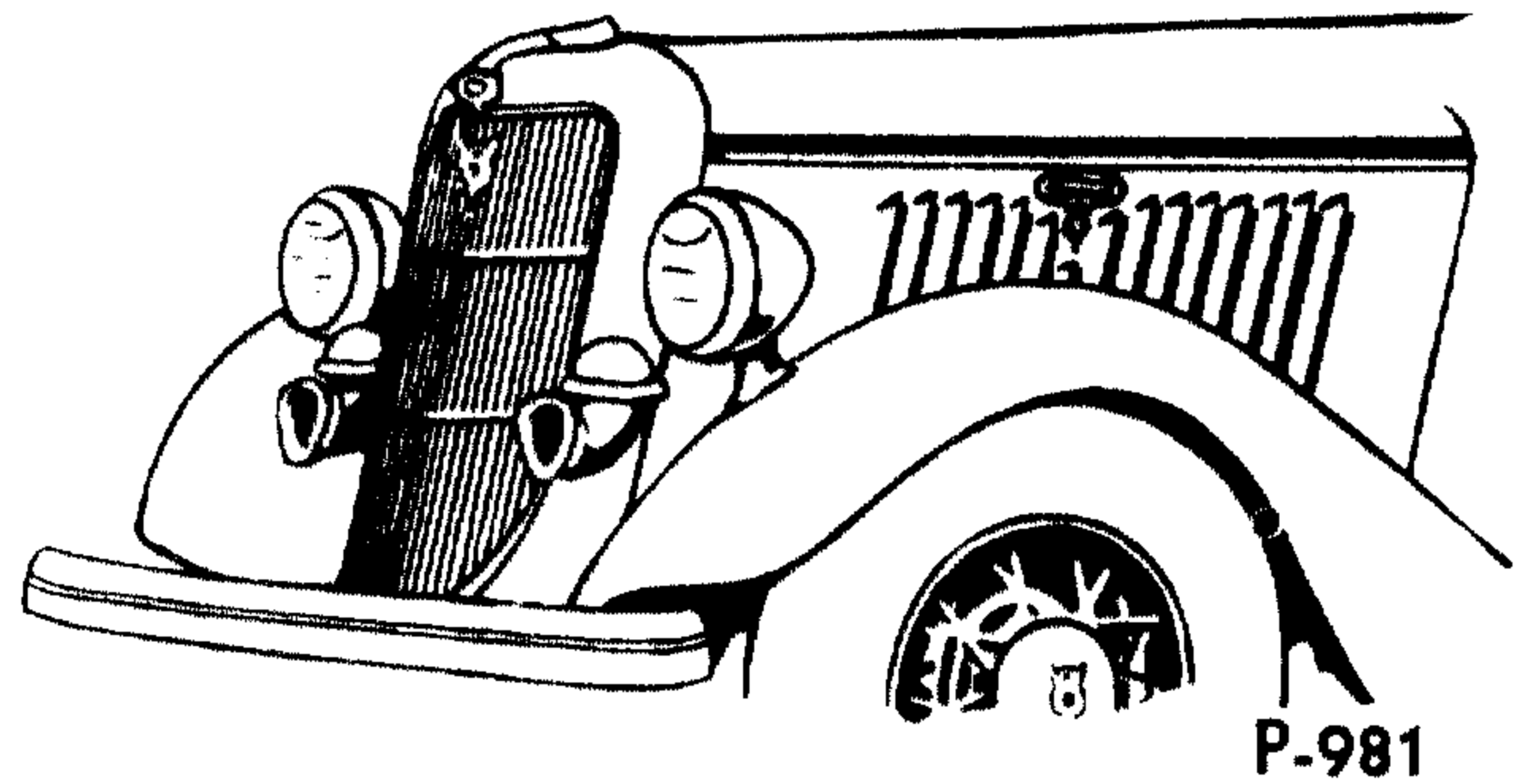

BODY TYPE	NAME	BODY TYPE	NAME
PASSENGER			
700	Tudor Sedan (Standard)	730	Fordor Sedan (Touring)
700	Tudor Sedan (De Luxe)	740	Convertible Sedan
700	Tudor Sedan (Touring)	750	Phaeton
710	Roadster	760	Cabriolet
720	Coupe (3 Window)	770	Coupe (Standard) (5 Window)
730	Fordor Sedan (Standard)	770	Coupe (De Luxe) (5 Window)
730	Fordor Sedan (De Luxe)		
COMMERCIAL AND TRUCK			
204	Dump Body (Wood)	810	Closed Cab
208	Dump Body (Galion)	820	Panel Delivery (112" Wheelbase)
780	Sedan Delivery	830	Pickup
790	Station Wagon	920	Panel Delivery (131½" Wheelbase)

1936

FORD PASSENGER, COMMERCIAL AND TRUCK MODELS

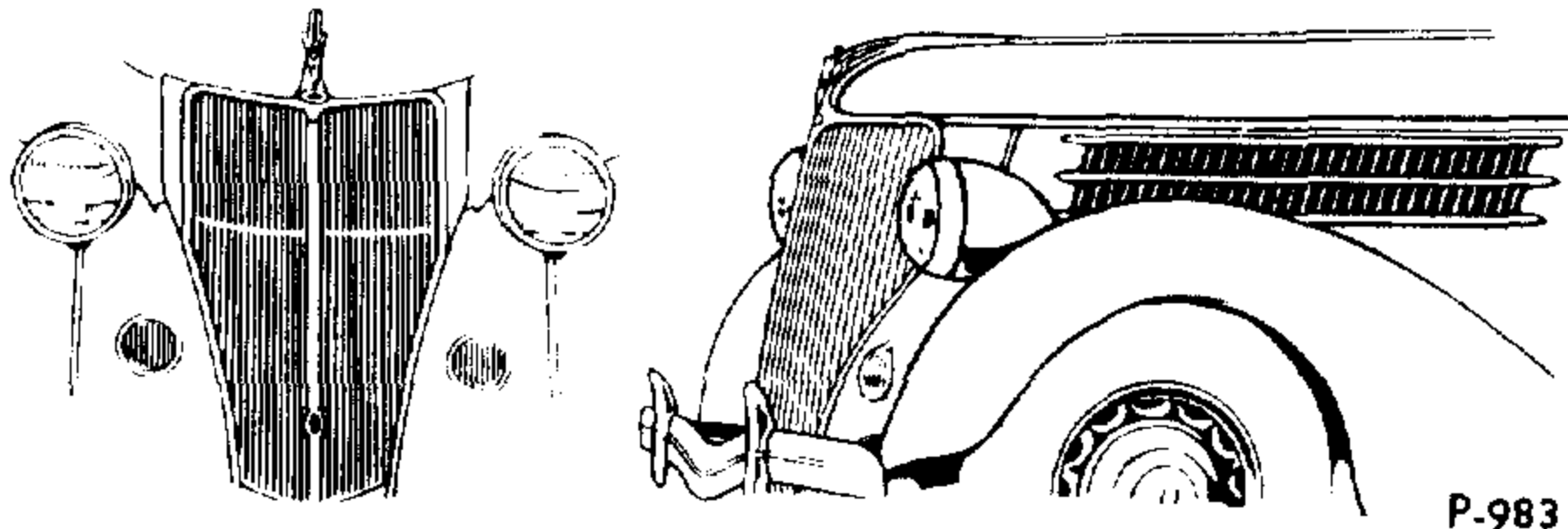

MODEL 68 FORD PASSENGER CAR
8 Cylinder Engine (112" Wheelbase)

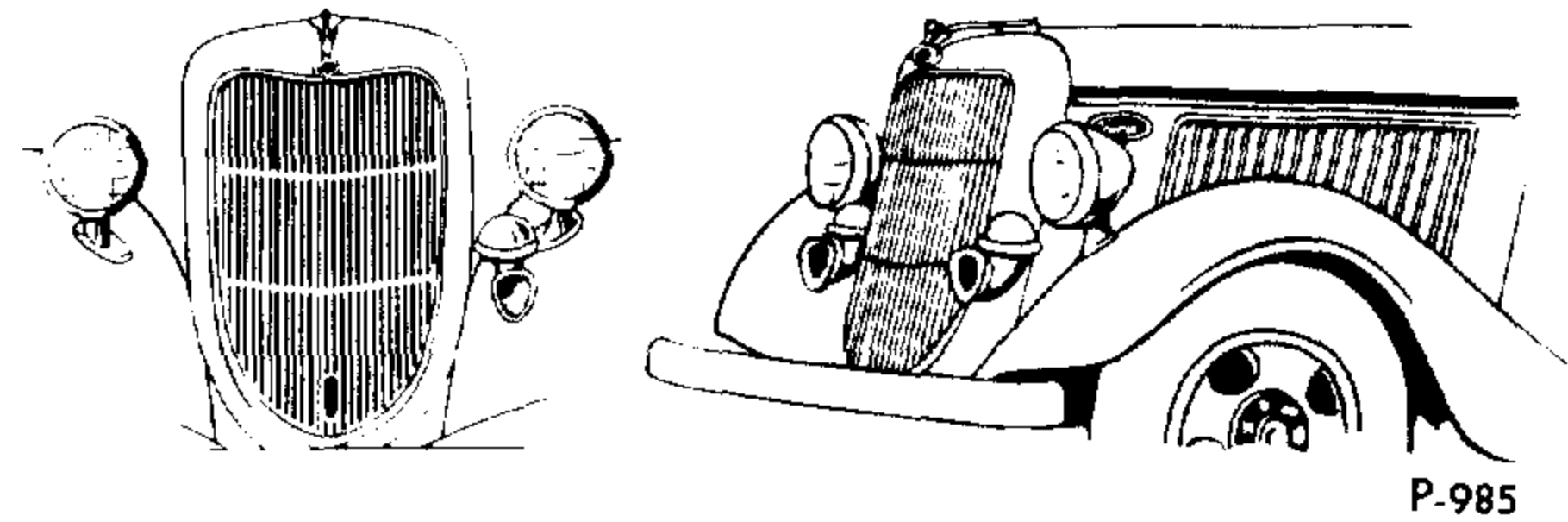

MODEL 51 FORD TRUCK
8 Cylinder Engine (131½" and 157" Wheelbase)

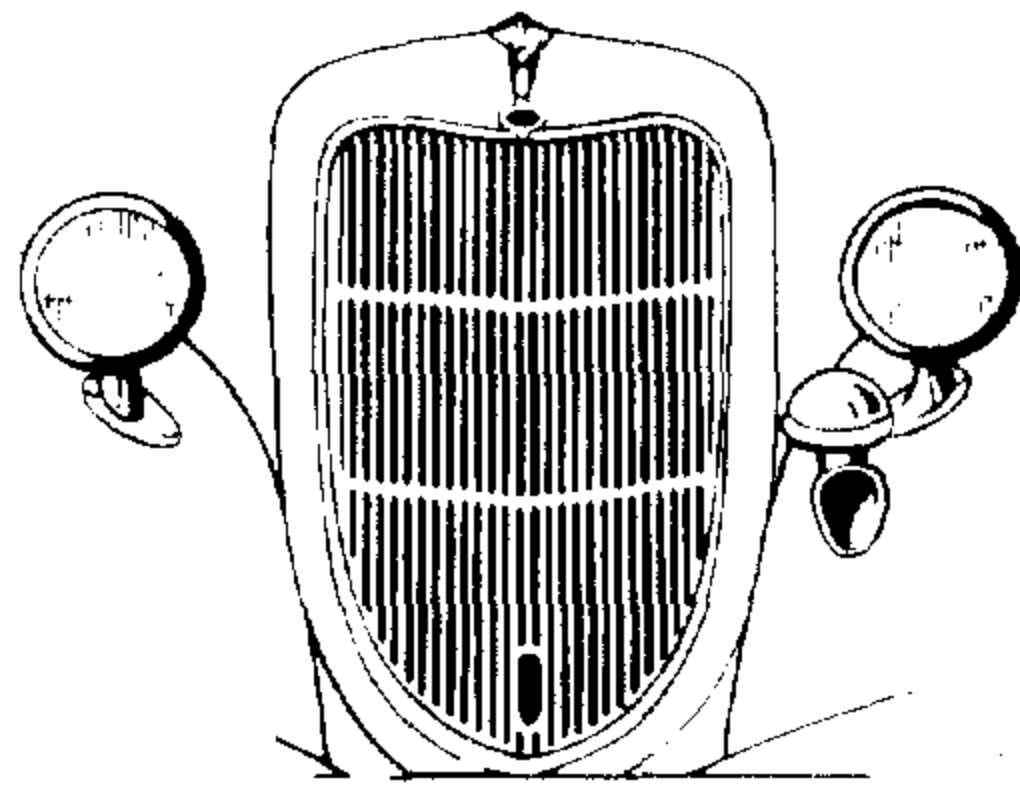

MODEL 67 FORD COMMERCIAL
8 Cylinder Engine (112" Wheelbase)

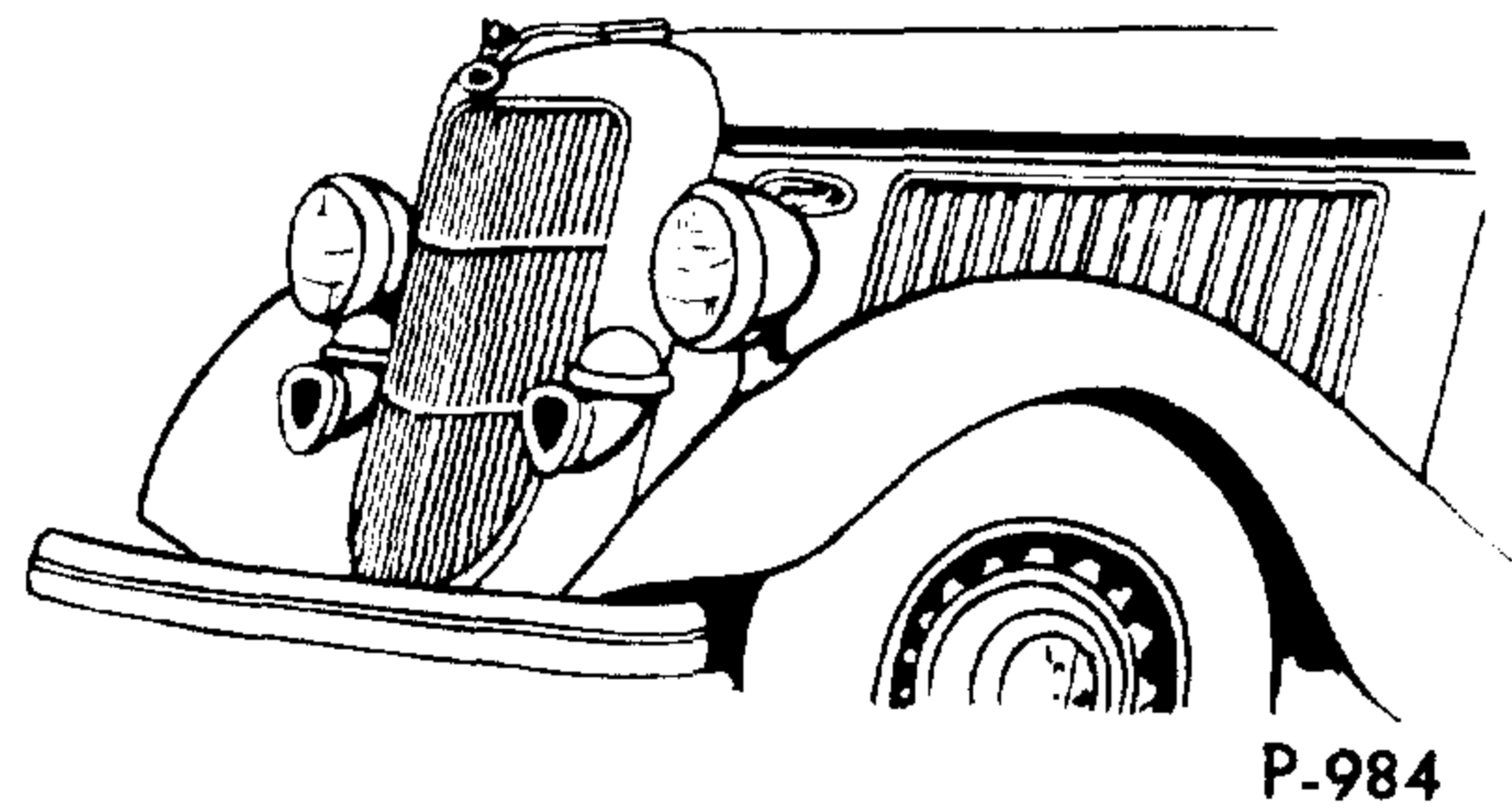

BODY TYPE	NAME	BODY TYPE	NAME
PASSENGER			
700	Tudor Sedan (Standard)	730	Fordor Sedan Touring (Standard)
700	Tudor Sedan (De Luxe)	730	Fordor Sedan Touring (De Luxe)
700	Tudor Sedan Touring (Standard)	740	Convertible Sedan
700	Tudor Sedan Touring (De Luxe)	750	Phaeton
710	Roadster	760	Cabriolet
720	Coupe (3 Window)	760	Club Cabriolet
730	Fordor Sedan (Standard)	770	Coupe (Standard) (5 Window)
730	Fordor Sedan (De Luxe)	770	Coupe (De Luxe) (5 Window)
COMMERCIAL AND TRUCK			
204	Dump Body (Wood)	810	Closed Cab
208	Dump Body (Galion)	820	Panel Delivery (112" Wheelbase)
780	Sedan Delivery	830	Pickup
790	Station Wagon	920	Panel Delivery (131½" Wheelbase)

1937

FORD PASSENGER, COMMERCIAL AND TRUCK MODELS

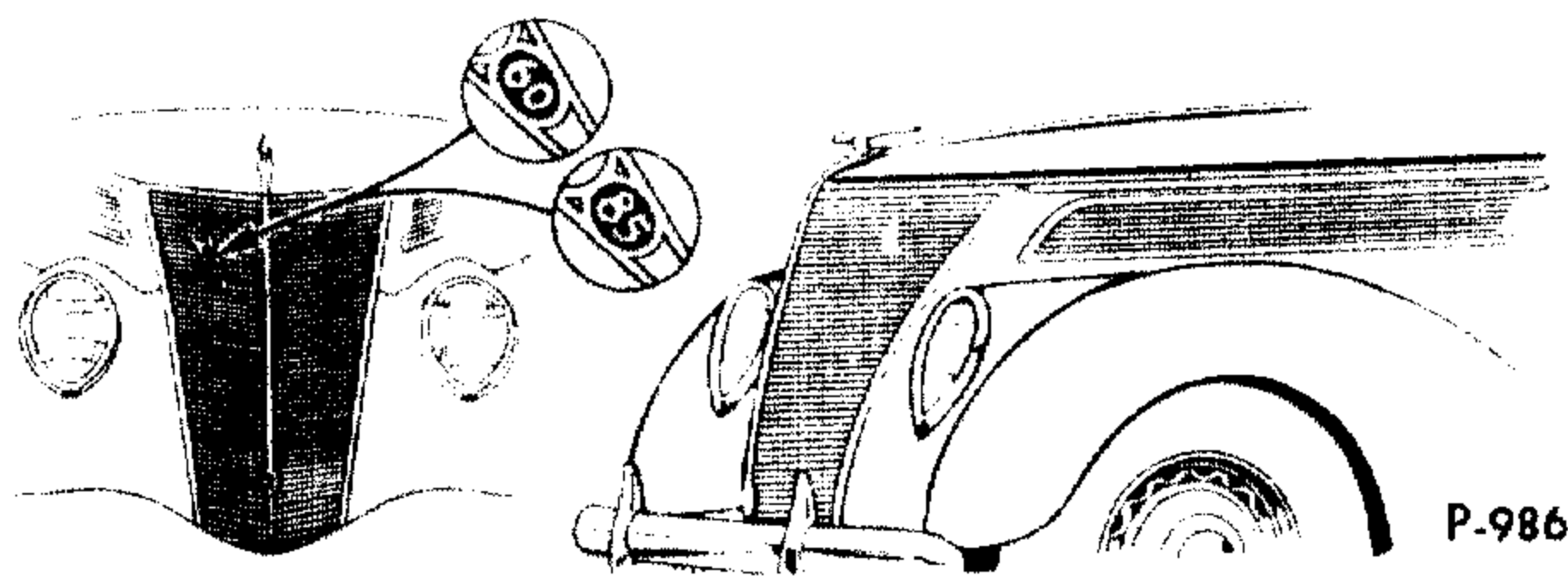

MODEL 78 FORD PASSENGER CAR
8 Cylinder *85 HP. Engine (112" Wheelbase)

MODEL 74 FORD PASSENGER CAR
8 Cylinder 60 HP. Engine (112" Wheelbase)

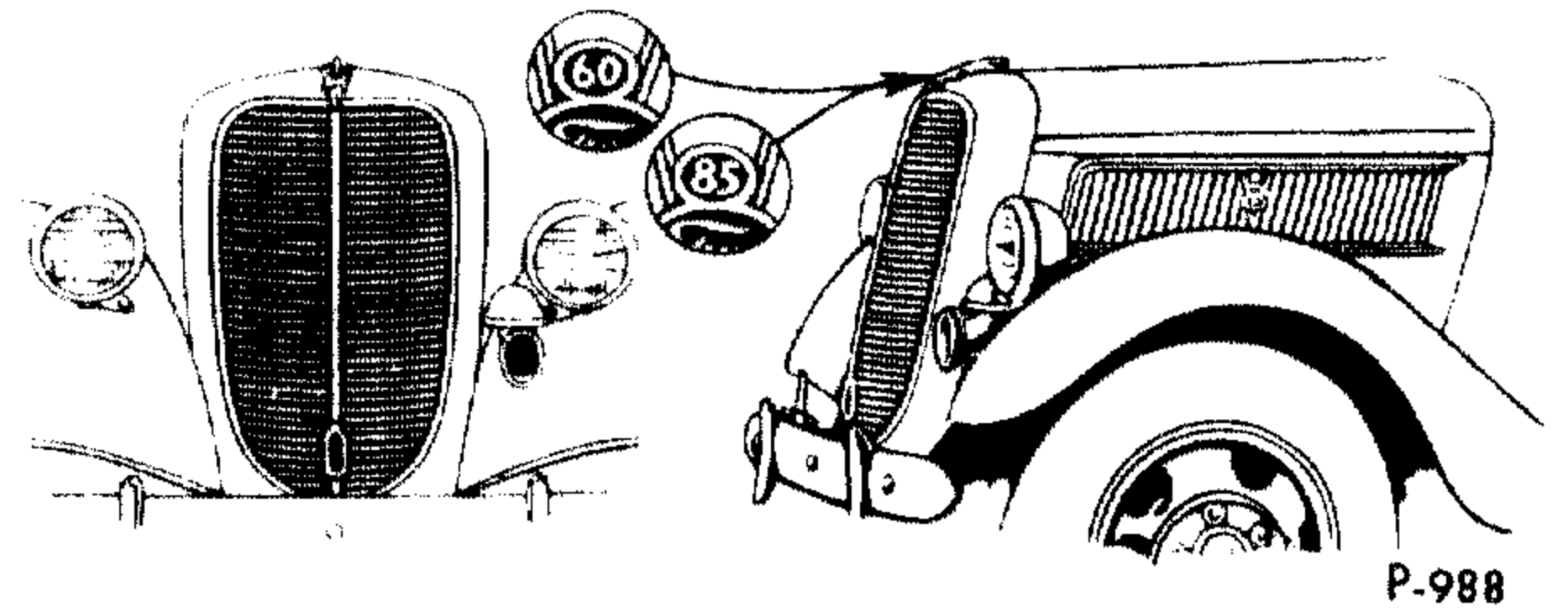

MODEL 79 FORD TRUCK
8 Cylinder *85 HP. Eng. (131½" and 157" Wheelbase)

MODEL 75 FORD TRUCK
8 Cylinder 60 HP. Engine (131½" Wheelbase)

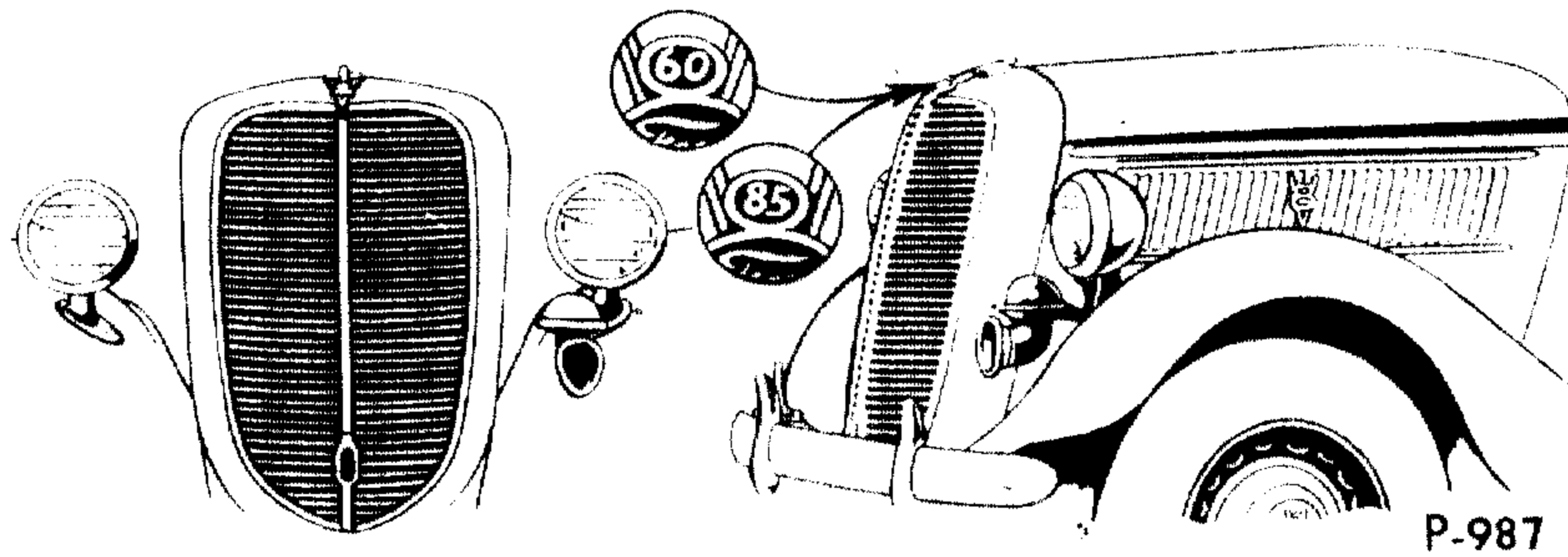

MODEL 77 FORD COMMERCIAL
8 Cylinder *85 HP. Engine (112" Wheelbase)

MODEL 73 FORD COMMERCIAL
8 Cylinder 60 HP. Engine (112" Wheelbase)

BODY TYPE	NAME	BODY TYPE	NAME
PASSENGER			
700-A	Tudor Sedan (Standard)	730-C	Fordor Sedan (Standard Touring)
700-B	Tudor Sedan (De Luxe)	730-D	Fordor Sedan (De Luxe Touring)
700-C	Tudor Sedan (Standard Touring)	740	Convertible Sedan
700-D	Tudor Sedan (De Luxe Touring)	750	Phaeton (Touring)
710	Roadster	760-A	Cabriolet
720	Coupe (Club)	760-B	Cabriolet (Club)
730-A	Fordor Sedan (Standard)	770-A	Coupe (Standard) (5 Window)
730-B	Fordor Sedan (De Luxe)	770-B	Coupe (De Luxe) (5 Window)
COMMERCIAL AND TRUCK			
204	Dump Body (Wood)	820	Panel Delivery (Standard and De Luxe) (112" Wheelbase)
208	Dump Body (Galion)	830	Pickup
780	Sedan Delivery (Standard)	830	Pickup (Coupe)
780	Sedan Delivery (De Luxe)	900	Platform (131½" Wheelbase)
790	Station Wagon	905	Stake Body complete (131½" Wheelbase)
800	Platform (112" Wheelbase)	920	Panel Delivery (Standard and De Luxe) (131½" Wheelbase)
805	Stake Body complete (112" Wheelbase)	950	Platform (157" Wheelbase)
810	Closed Cab (Standard)	955	Stake Body complete (157" Wheelbase)
810	Closed Cab (De Luxe)		

*Listed throughout catalogue as 90 HP.

1938

FORD PASSENGER CAR MODELS

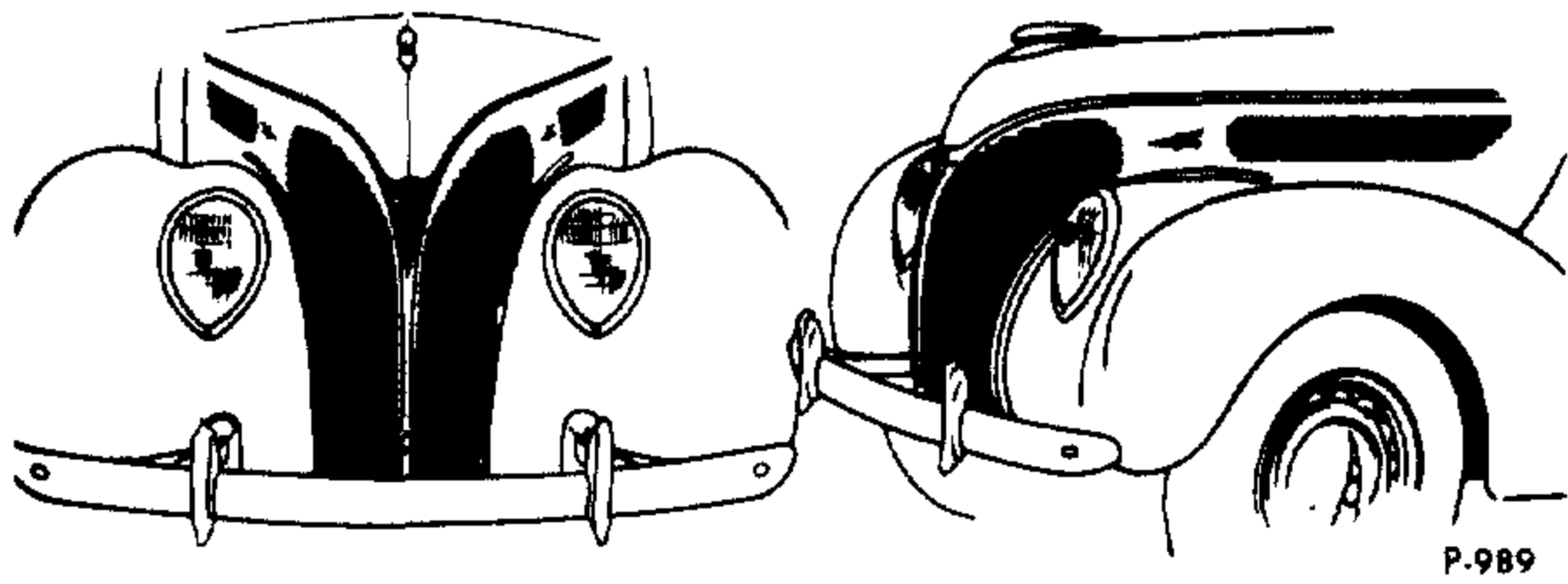

MODEL 81A FORD DELUXE
*85 HP. 8-Cylinder Engine
(112" Wheelbase)

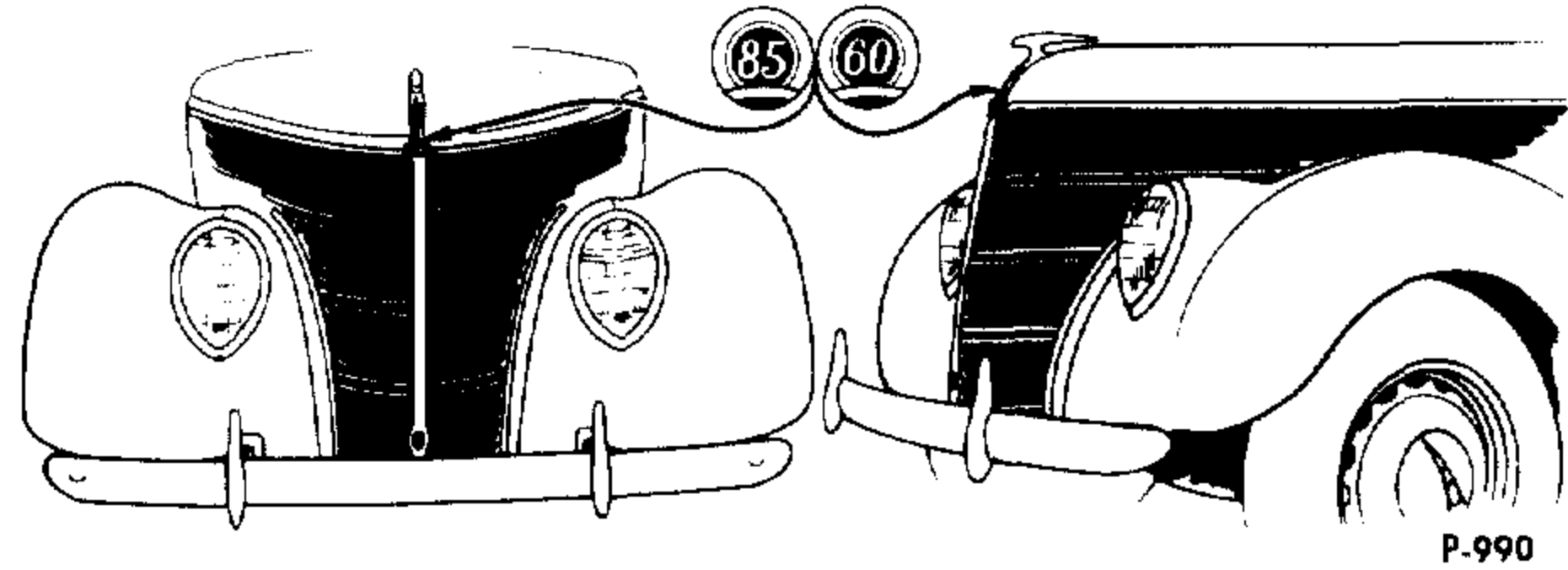

MODEL 81A FORD STANDARD
*85 HP. 8-Cylinder Engine
MODEL 82A FORD 60 HP. 8-Cylinder Engine
(112" Wheelbase)

BODY TYPE	N A M E	BODY TYPE	N A M E
700-B	De Luxe Tudor Sedan	760-B	De Luxe Convertible Club Coupe
700-C	Standard Tudor Sedan	770-A	Standard (5-Window) Coupe
720	De Luxe Club Coupe	770-B	De Luxe (5-Window) Coupe
730-B	De Luxe Fordor Sedan	770-C	Standard (5-Window) Coupe (with pickup)
730-C	Standard Fordor Sedan	780-A	Standard Sedan Delivery
740	De Luxe Convertible Sedan	780-B	De Luxe Sedan Delivery
750	De Luxe Phaeton	790	Station Wagon
760-A	De Luxe Convertible Coupe		

*Listed throughout Catalogue as 90 HP.



1938

FORD COMMERCIAL AND TRUCK MODELS

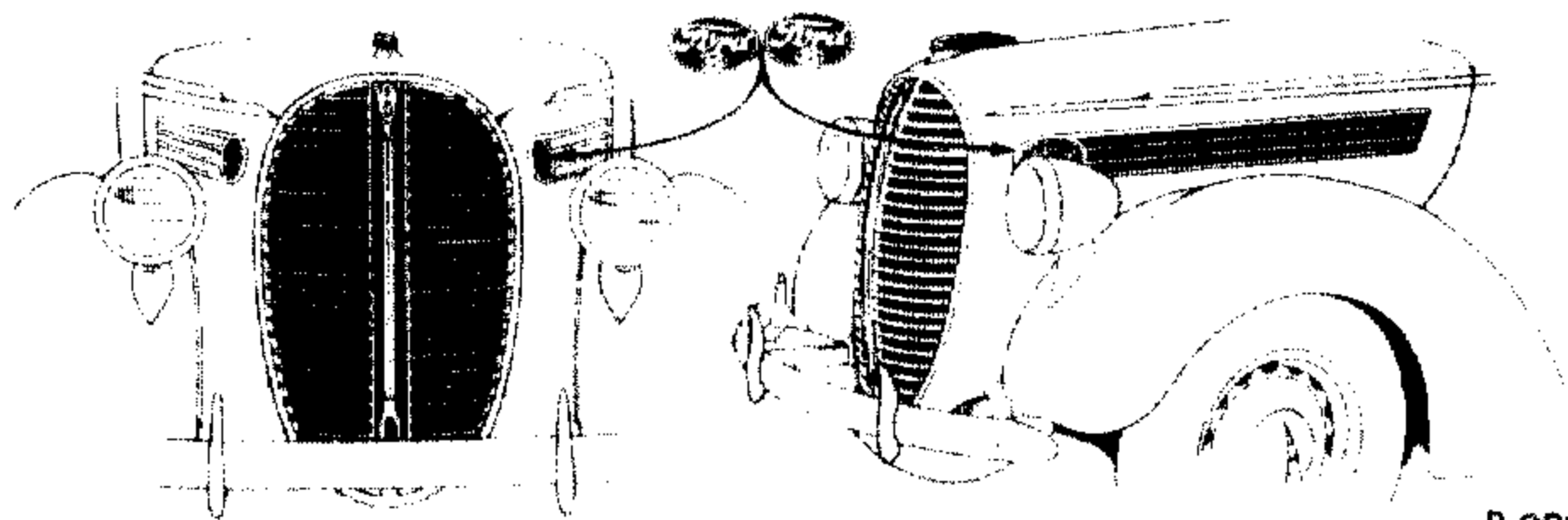

P-991

MODEL 81C FORD COMMERCIAL
*85 HP. 8-Cylinder Engine

MODEL 82C FORD COMMERCIAL
60 HP. 8-Cylinder Engine
(112" Wheelbase)

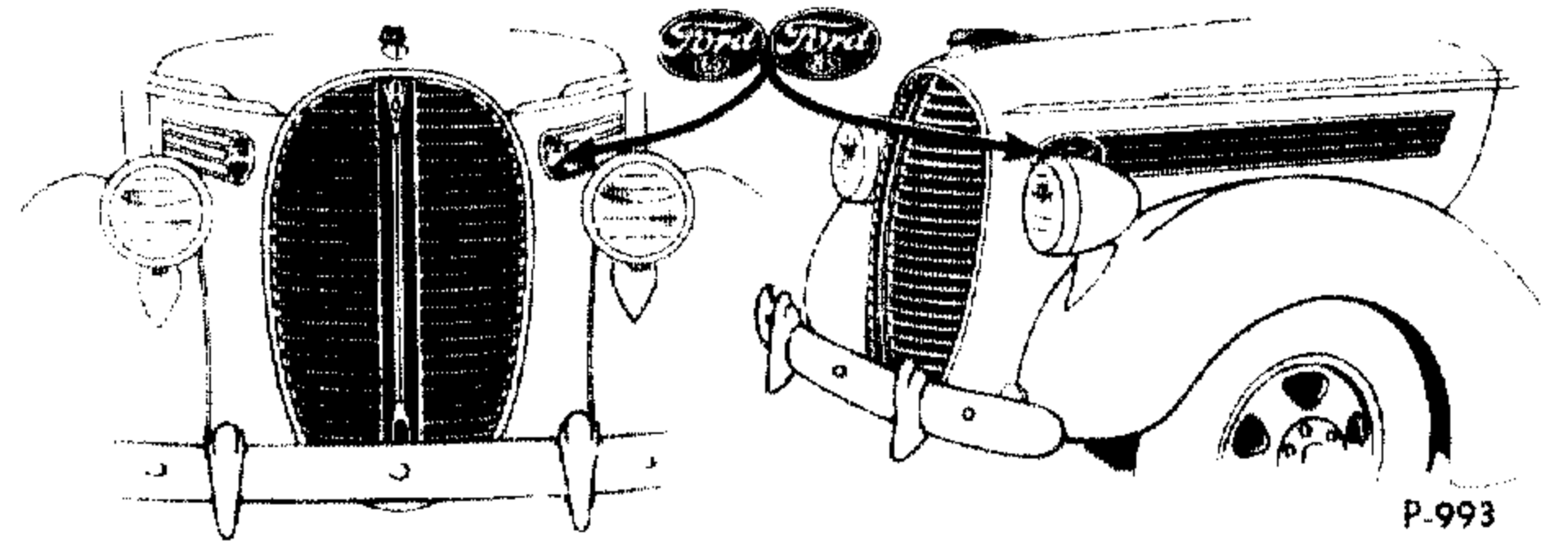

P-993

FORD REGULAR TRUCK
*85 HP. 8-Cylinder Engine

MODEL	WHEELBASE
81T.....	134"
817T.....	157"
§ 81U.....	134"
▷811T.....	191"
◇ School Bus Chassis	
§ Dump Chassis	

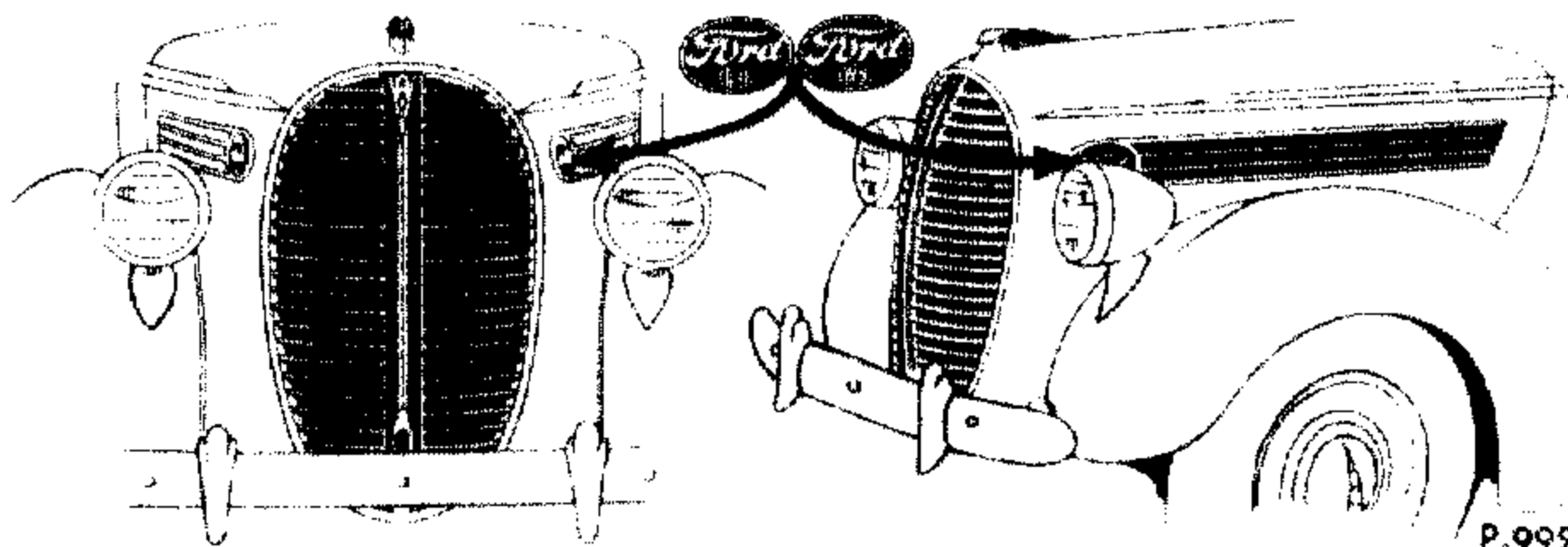

P-992

MODEL 81Y FORD 1 TON TRUCK
*85 HP. 8-Cylinder Engine

MODEL 82Y FORD 1 TON TRUCK
60 HP. 8-Cylinder Engine
(122" Wheelbase)

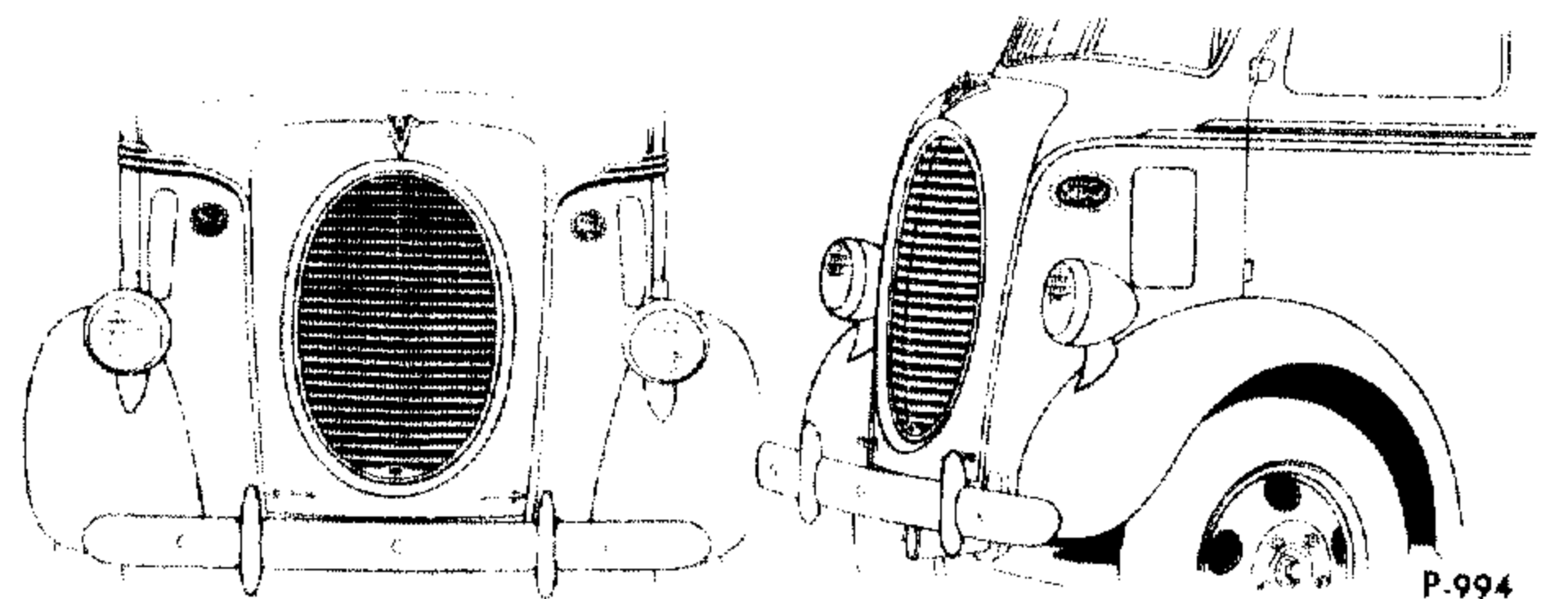

P-994

FORD CAB-OVER-ENGINE TRUCK
*85 HP. 8-Cylinder Engine

MODEL	WHEELBASE
811W.....	101"
81W.....	134"
817W.....	157"
§811Z.....	101"
§ Dump Chassis	

BODY TYPE	NAME	BODY TYPE	NAME
204	Dump Body (Wood) (134" Wheelbase)	830	Pickup (112" Wheelbase)
W-204	Dump Body (Wood) (101" Cab-Over-Engine)	830	Express (122" Wheelbase)
208	Dump Body (Galion) (134" Wheelbase)	900	Platform (122" Wheelbase)
208	Dump Body (Galion) (101" Cab-Over-Engine)	900	Platform (134" Wheelbase)
800	Platform (112" Wheelbase)	900	Platform (101" Cab-Over-Engine)
805	Platform and Rack Assembly (112" Wheelbase)	920	Panel Delivery (122" Wheelbase)
810	Closed Cab (112" Chassis)	920	Panel Delivery (134" Wheelbase)
810	Closed Cab (122", 134" and 157" Chassis)	950	Platform (157" Wheelbase)
810	Closed Cab (Cab-Over-Engine Chassis)	950	Platform (134" Cab-Over-Engine)
820	Panel Delivery (112" Wheelbase)	955	Platform and Rack Assembly (157" Wheelbase)
		955	Platform and Rack Assembly (134" Cab-Over-Engine)

*Listed throughout Catalogue as 90 HP.

1939

FORD PASSENGER CAR MODELS

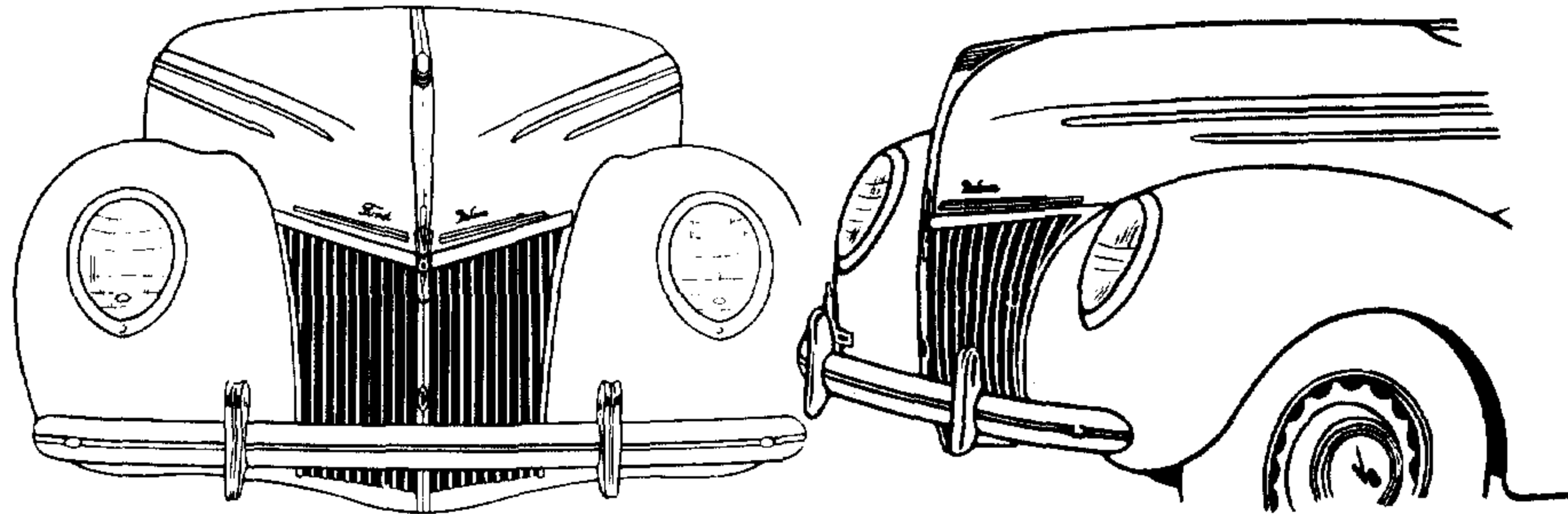

P-995

MODEL 91A FORD DELUXE
***85 HP. 8-Cylinder Engine**
 (112" Wheelbase)

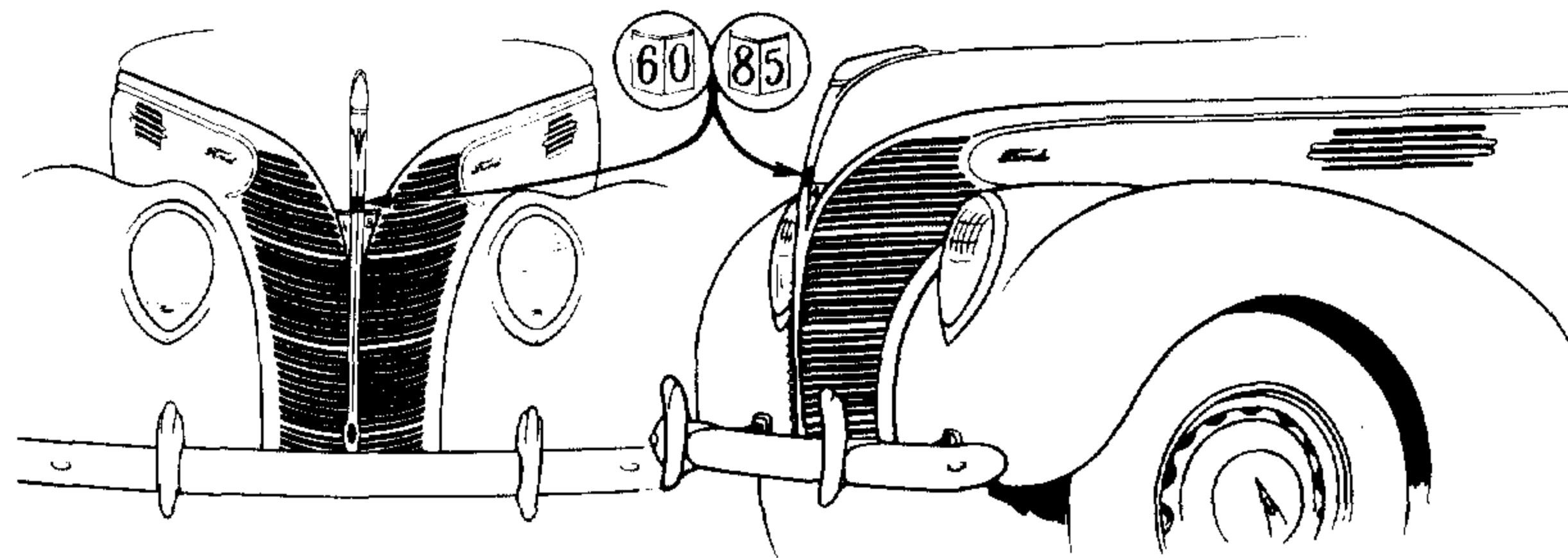

P-996

MODEL 91A FORD STANDARD *85 HP. 8-Cylinder Engine
MODEL 922A FORD 60 HP. 8-Cylinder Engine
 (112" Wheelbase)

BODY TYPE	NAME	BODY TYPE	NAME
70-A	Standard Tudor Sedan	76	De Luxe Convertible Coupe
70-B	De Luxe Tudor Sedan	77-A	Standard (5-Window) Coupe
73-A	Standard Fordor Sedan	77-B	De Luxe (5-Window) Coupe
73-B	De Luxe Fordor Sedan	78	Sedan Delivery
74	De Luxe Convertible Fordor Sedan	79	Station Wagon

*Listed throughout Catalogue as 90 HP.

1939

FORD COMMERCIAL AND TRUCK MODELS

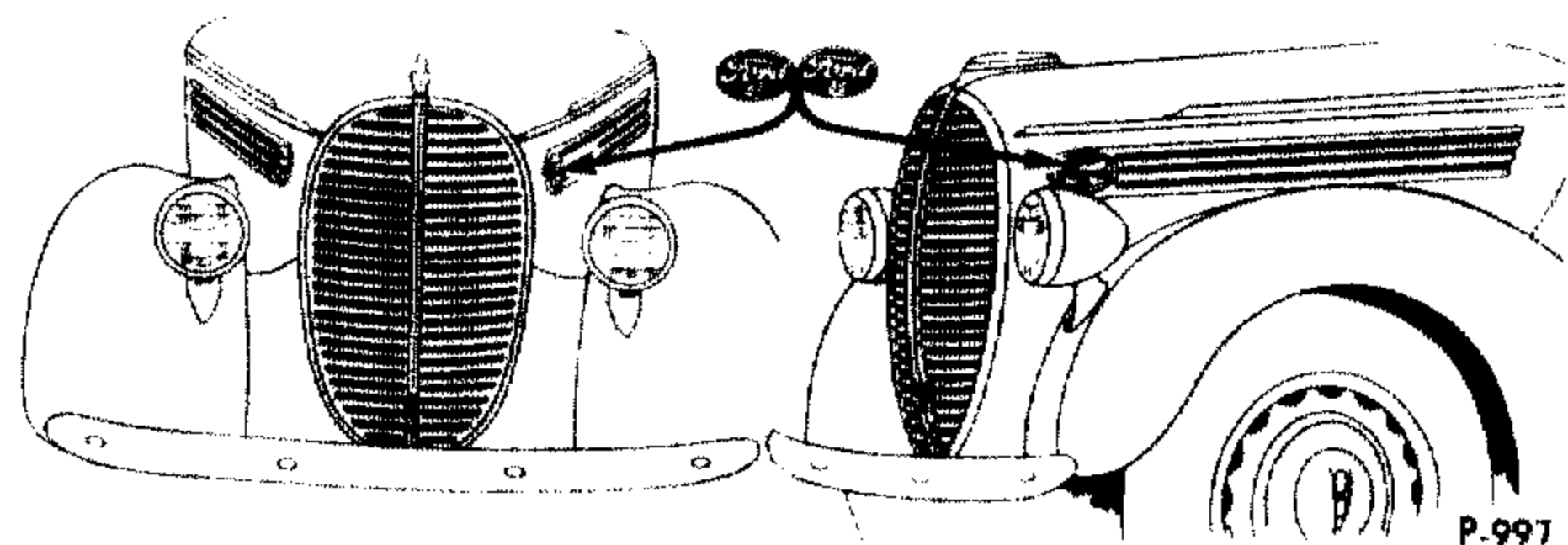

FORD COMMERCIAL

MODEL	WHEELBASE
60 HP. 922C	
*85 HP. 91C	
**95 HP. 99C	112"

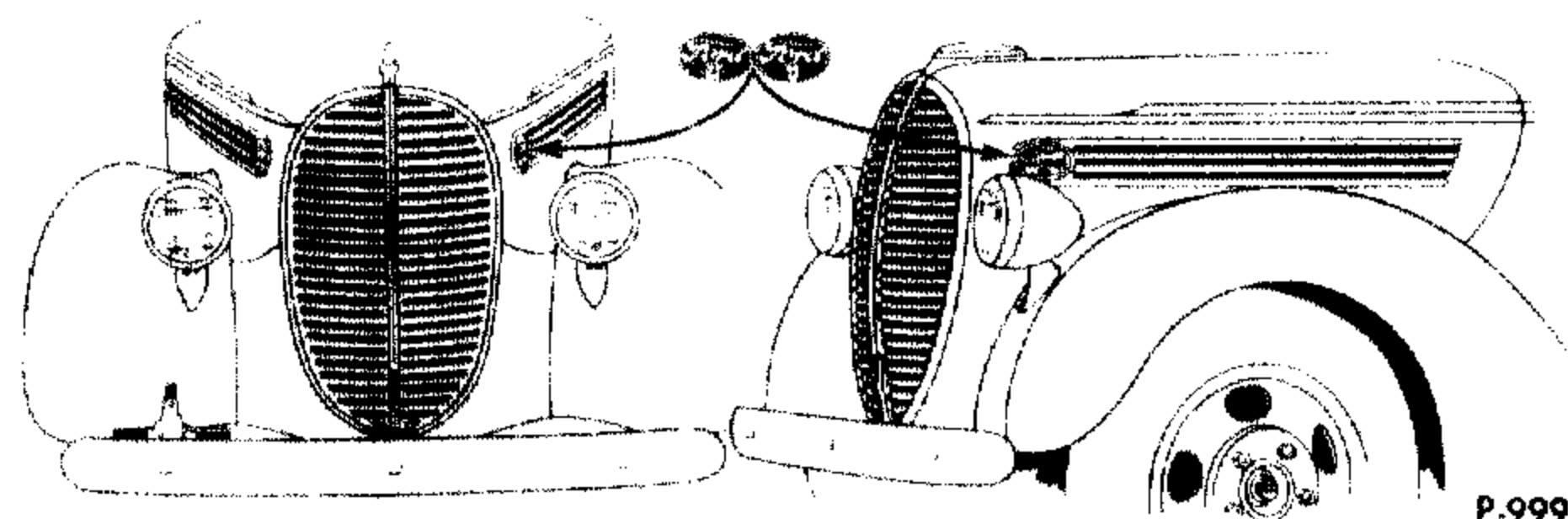

FORD REGULAR TRUCK

MODEL	WHEELBASE
*85 HP. 91T	
**95 HP. 99T	134"
917T	157"
◇911T	191"
§ 91U	134"
◇ School Bus Chassis	§ Dump Chassis

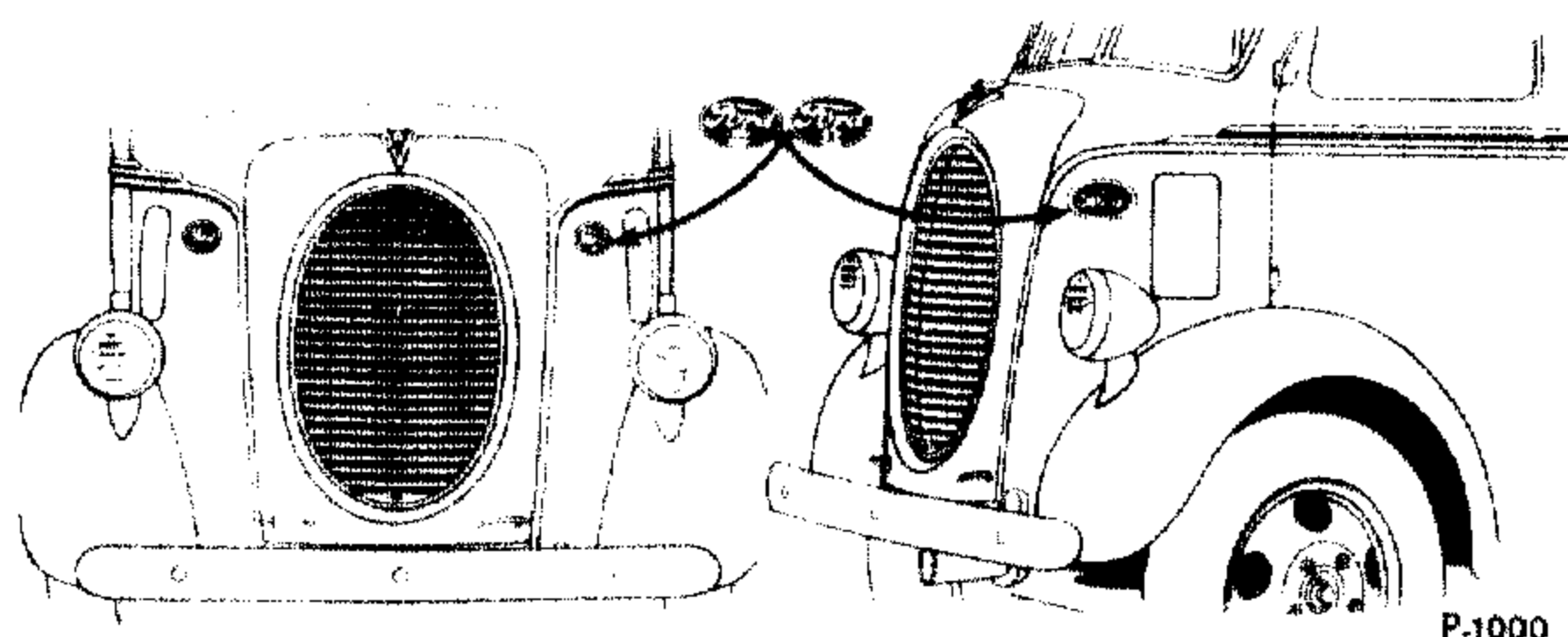

FORD CAB-OVER-ENGINE

MODEL	WHEELBASE
*85 HP. 991W	101"
**95 HP. 91W	134"
917W	157"
§911Z	101"
§Dump Chassis	

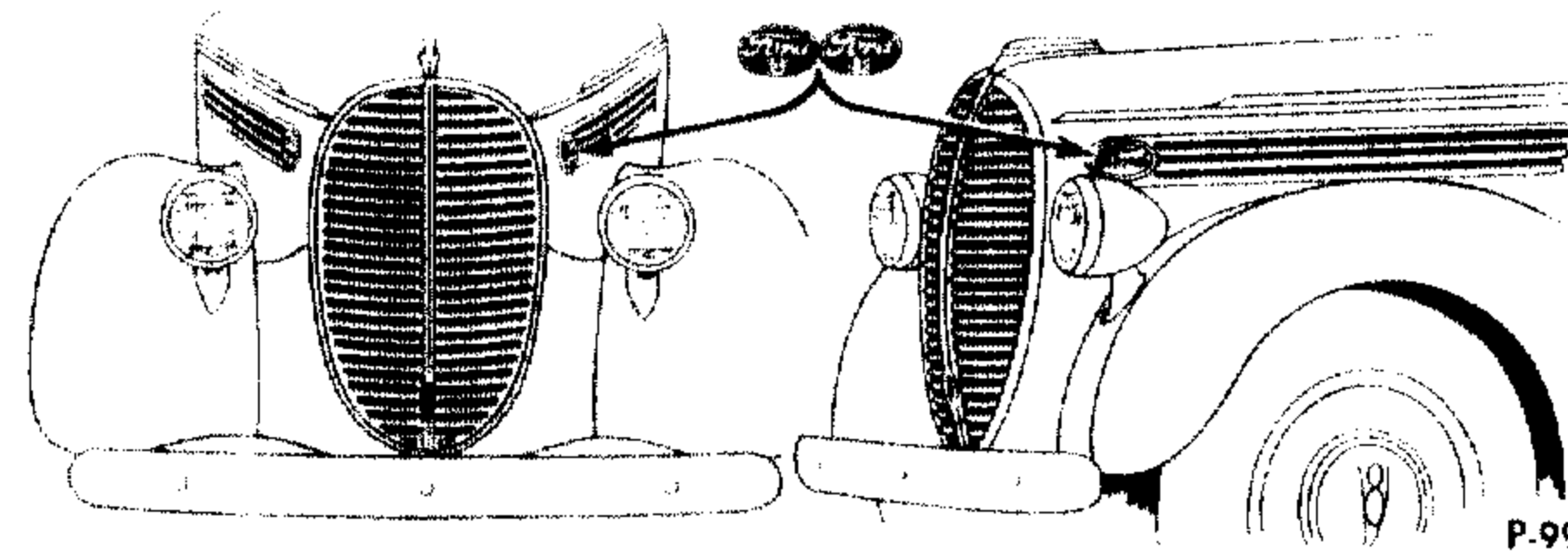

FORD 1 TON TRUCK

MODEL	WHEELBASE
60 HP. 92Y	
*85 HP. 91Y	122"
*95 HP. 99Y	

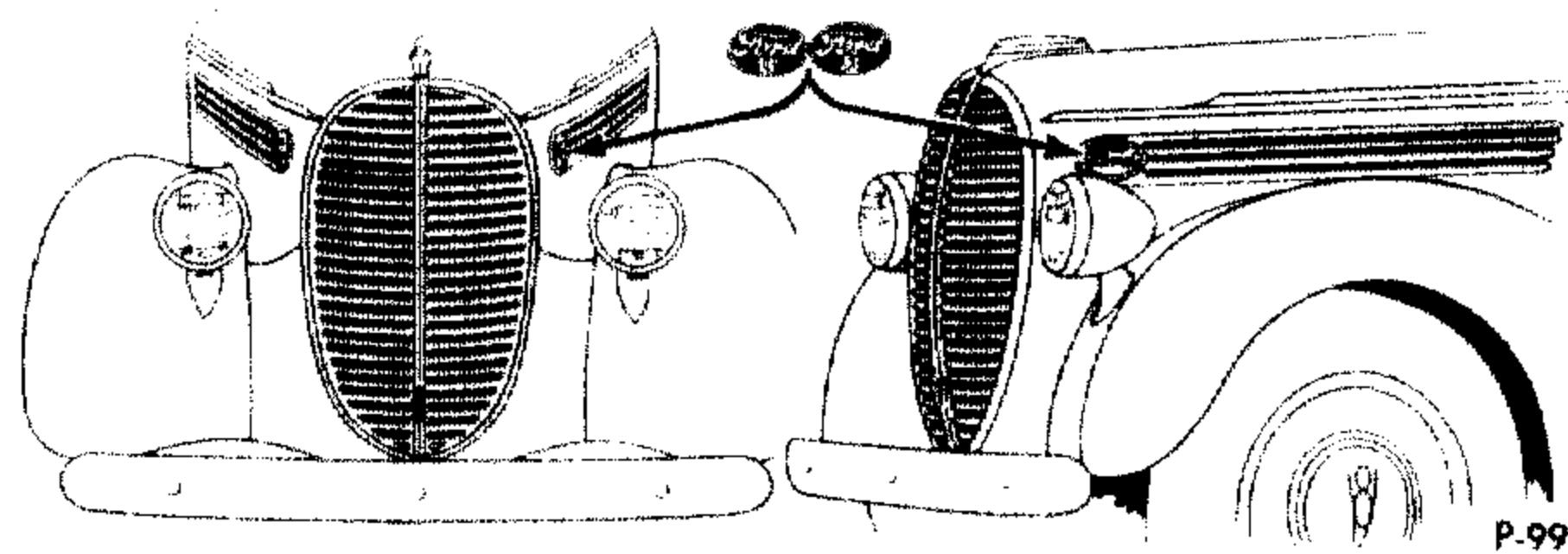

FORD 3/4 TON TRUCK

MODEL	WHEELBASE
60 HP. 92D	
*85 HP. 91D	122"
**95 HP. 99D	

BODY TYPE	NAME
80	Platform (112" Wheelbase)
80	Platform (3/4 Ton) (122" Wheelbase)
80	Platform (1 Ton) (122" Wheelbase)
80	Platform (134" Regular and 101" Cab-Over-Engine)
80	Platform (134" Cab-Over-Engine)
80	Platform (157" Wheelbase)
81	Closed Cab (122" Chassis)
81	Closed Cab (122", 134" and 157" Chassis)
81	Closed Cab (Cab-Over-Engine Chassis)
82-A	Panel Delivery (with slats) (112" Wheelbase)
82-B	Panel Delivery (with masonite) (112" Wheelbase)

BODY TYPE	NAME
82	Panel Delivery (3/4 Ton) (122" Wheelbase)
82	Panel Delivery (1 Ton) (122" Wheelbase)
82	Panel Delivery (134" Wheelbase)
83	Pickup (112" Wheelbase)
83	Express (3/4 Ton) (122" Wheelbase)
83	Express (1 Ton) (122" Wheelbase)
87	Dump Body (Wood) (134" Wheelbase)
88	Dump Body (Galion) (134" Wheelbase)
87	Dump Body (Wood) (101" Cab-Over-Engine)
88	Dump Body (Galion) (101" Cab-Over-Engine)

*Listed throughout Catalogue as 90 HP.
 **Listed throughout Catalogue as 100 HP.

1940

FORD PASSENGER CAR MODELS

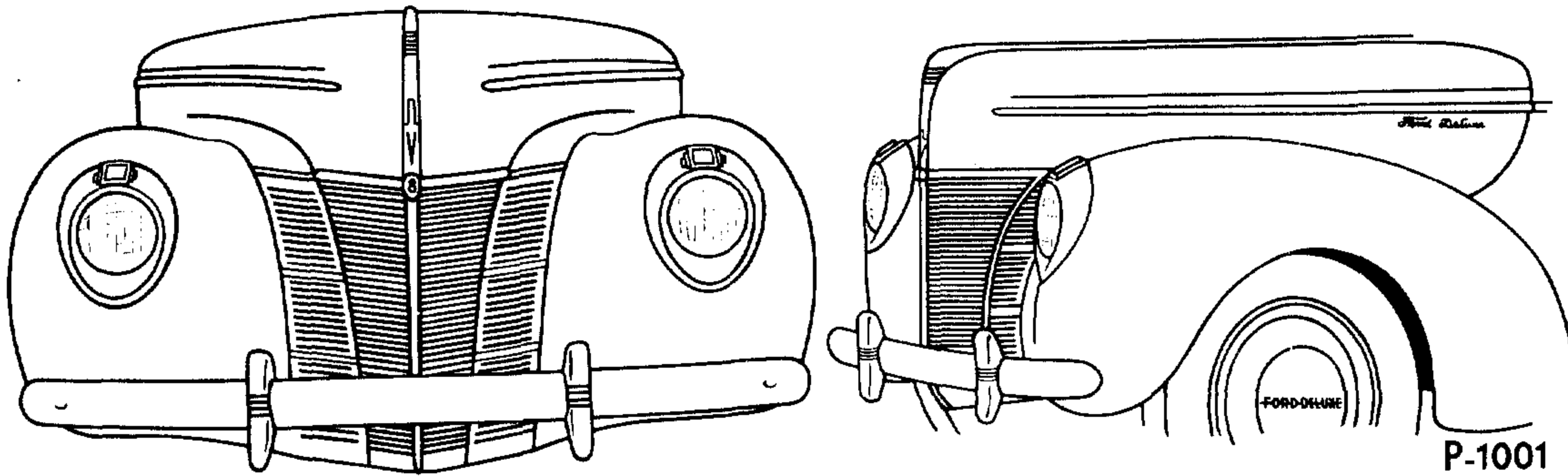

MODEL 01A FORD DELUXE
***85 HP. 8-Cylinder Engine**
 (112" Wheelbase)

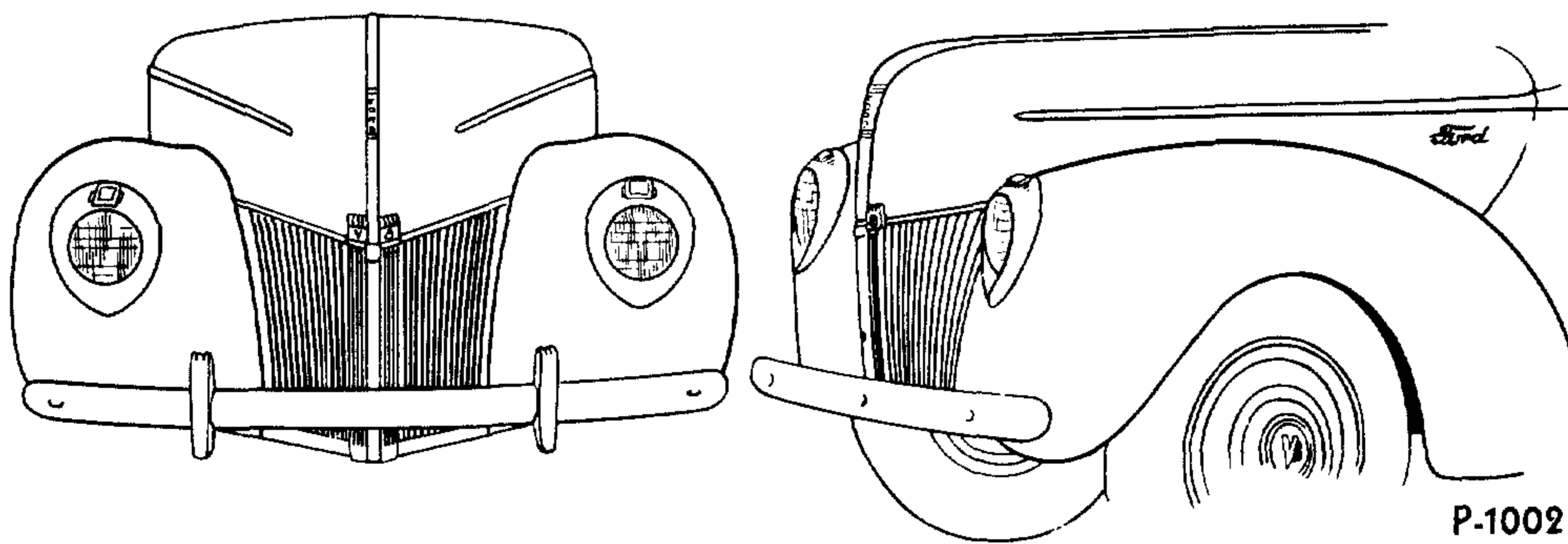

MODEL 01A FORD—STANDARD *85 HP. 8-Cylinder Engine
MODEL 022A FORD—60 HP. 8-Cylinder Engine
 (112" Wheelbase)

BODY TYPE	NAME	BODY TYPE	NAME
66	De Luxe Convertible Club Coupe	73-B	De Luxe Fordor Sedan
67-A	Standard Business Coupe	77-A	Standard (5-Window) Coupe
67-B	De Luxe Business Coupe	77-B	De Luxe (5-Window) Coupe
70-A	Standard Tudor Sedan	78	De Luxe Sedan Delivery
70-B	De Luxe Tudor Sedan	79-A	Standard Station Wagon
73-A	Standard Fordor Sedan	79-B	De Luxe Station Wagon

*Listed throughout Catalogue as 90 HP.

1940

FORD COMMERCIAL AND TRUCK MODELS

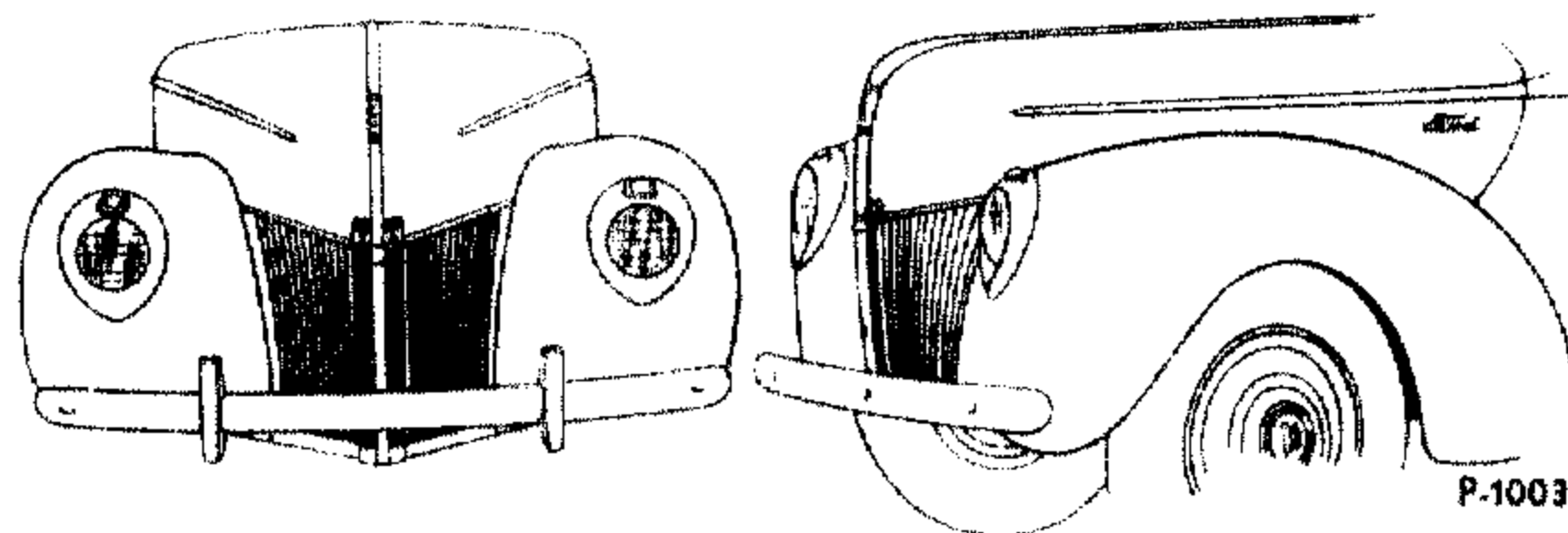

FORD COMMERCIAL

60 HP.	*85 HP.	**95 HP.	WHEELBASE
02C	01C	09C	112"

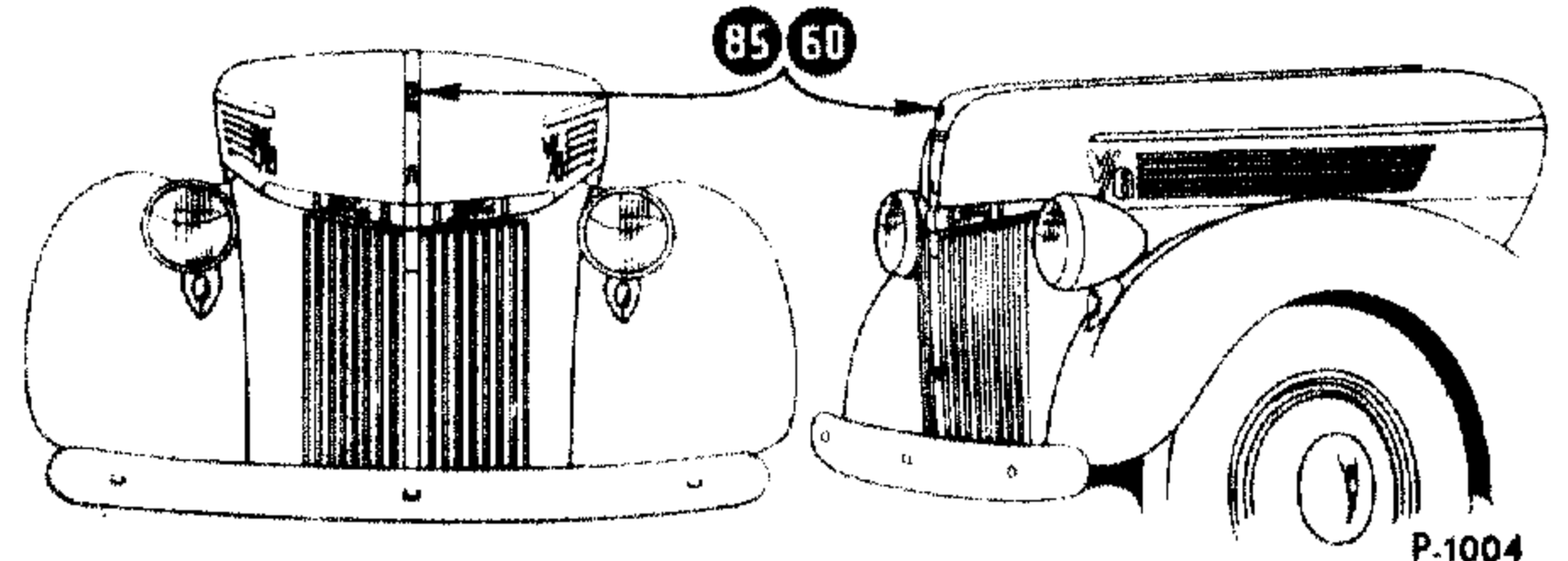

FORD 3/4 TON TRUCK

60 HP.	*85 HP.	**95 HP.	WHEELBASE
02D	01D	09D	122"

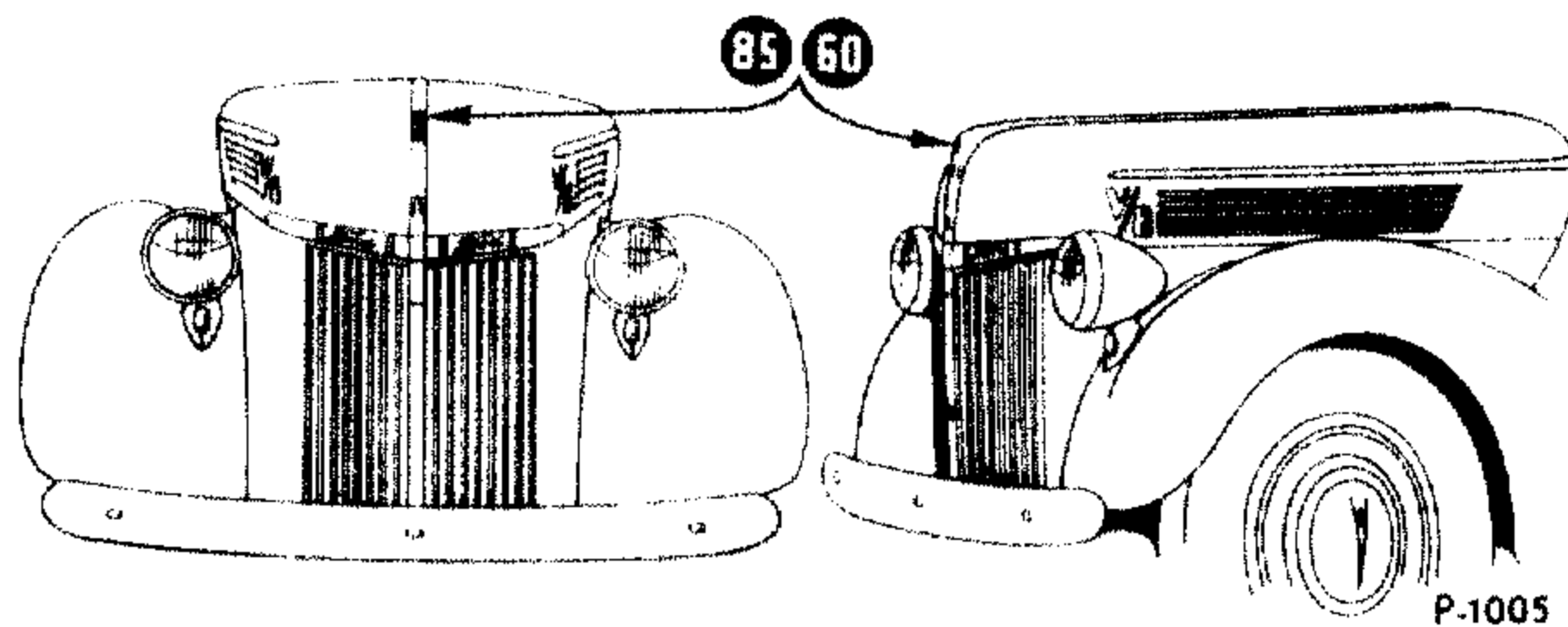

FORD 1 TON TRUCK

60 HP.	*85 HP.	**95 HP.	WHEELBASE
02Y	01Y	09Y	122"

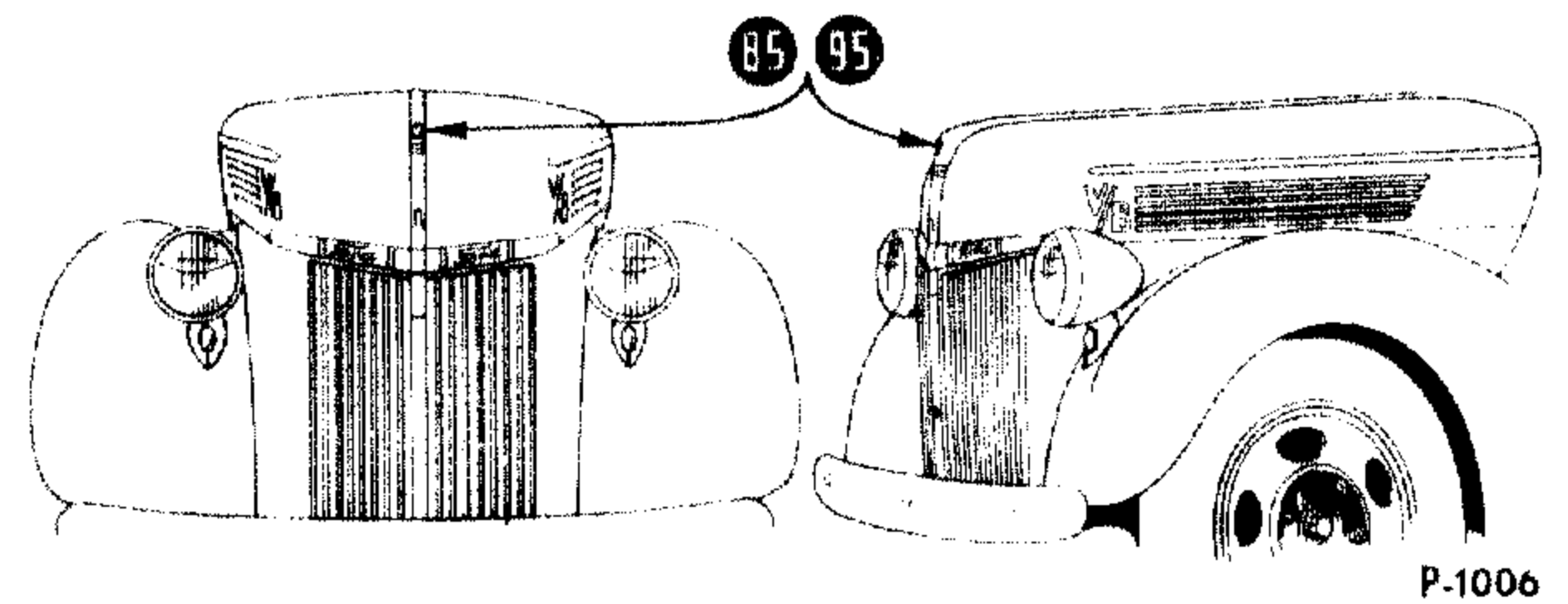

FORD REGULAR TRUCK

MODEL		WHEELBASE
*85 HP.	**95 HP.	
01T	09T	134"
018T	098T	158"
§ 01U	§ 09U	134"
◇ 014T	◇ 094T	194"

◇ School Bus Chassis
§ Dump Chassis

FORD CAB-OVER-ENGINE →

MODEL		WHEELBASE
*85 HP.	**95 HP.	
011W	091W	101"
01W	09W	134"
018W	098W	158"

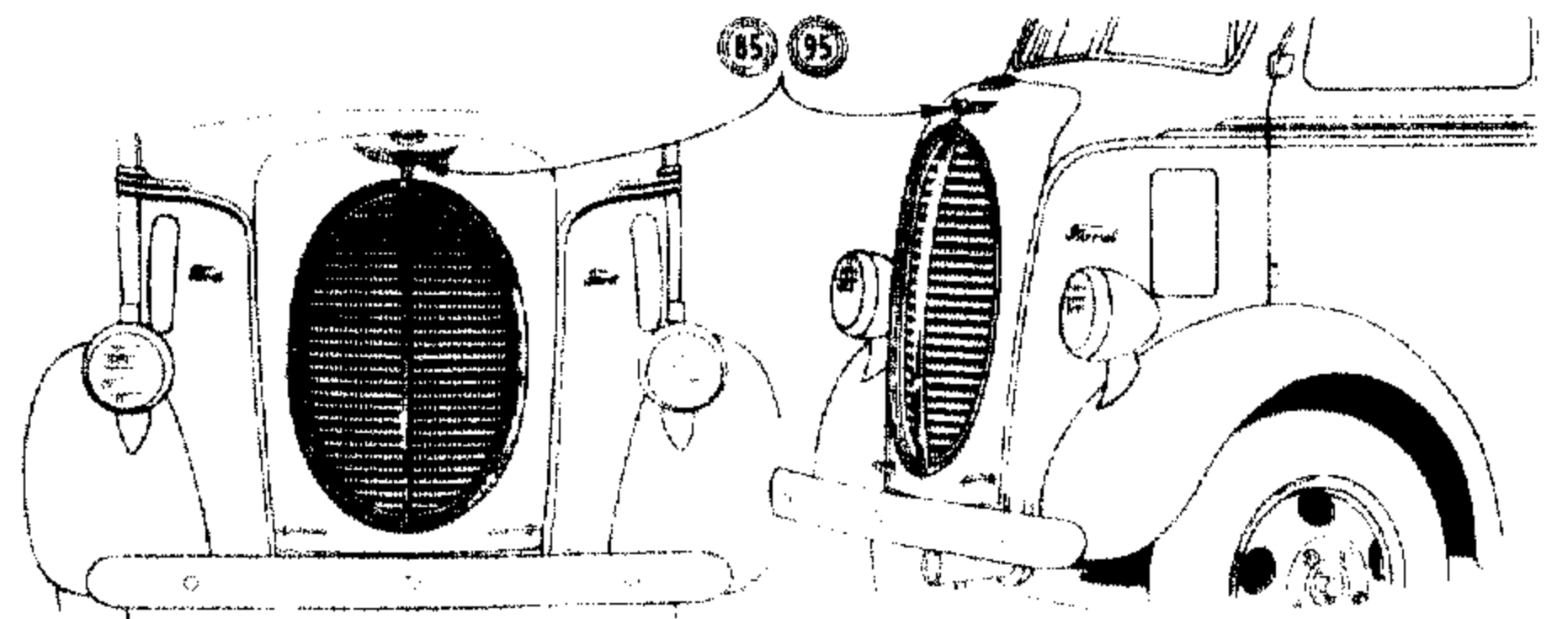

BODY TYPE	NAME	BODY TYPE	NAME
80	Platform (112" Wheelbase)	81	Closed Cab (Cab-Over-Engine)
80	Platform (3/4 Ton) (122" Wheelbase)	82-A	Panel Delivery (with slats) (112" Wheelbase)
80	Platform (1 Ton) (122" Wheelbase)	82-B	Panel Delivery (with masonite) (112" Wheelbase)
80	Platform (134" Reg.) (101" Cab-Over-Engine)	82	Panel Delivery (3/4 Ton) (122" Wheelbase)
80	Platform (134" Cab-Over-Engine)	82	Panel Delivery (1 Ton) (122" Wheelbase)
80	Platform (158" Wheelbase—Reg.)	82	Panel Delivery (134" Wheelbase)
81	Closed Cab (112" Wheelbase)	83	Pickup (112" Wheelbase)
81	Closed Cab (122", 134", 158" Wheelbase—Reg.)	83	Express (3/4 Ton) (122" Wheelbase)
	*Listed throughout Catalogue as 90 HP.	83	Express (1 Ton) (122" Wheelbase)
	**Listed throughout Catalogue as 100 HP.		

1941

FORD PASSENGER CAR MODELS

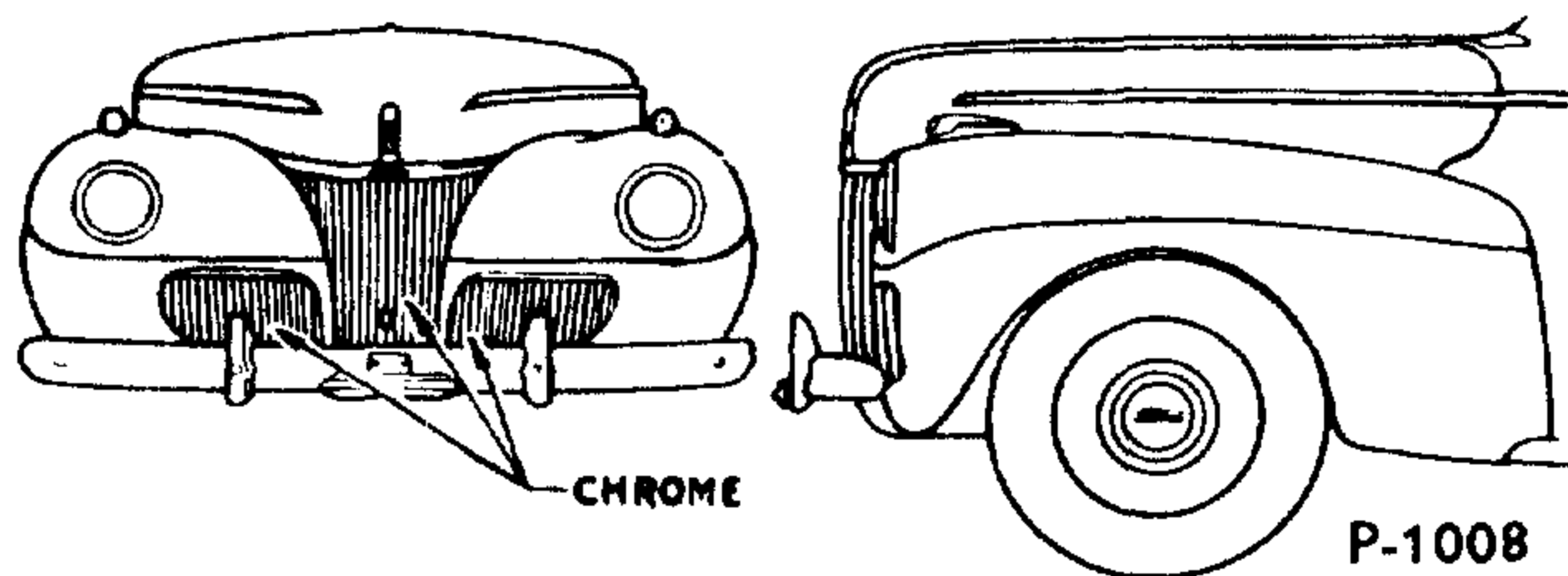

MODEL 11A FORD SUPER DELUXE
90 HP. 8-Cylinder Engine
 (114" Wheelbase)

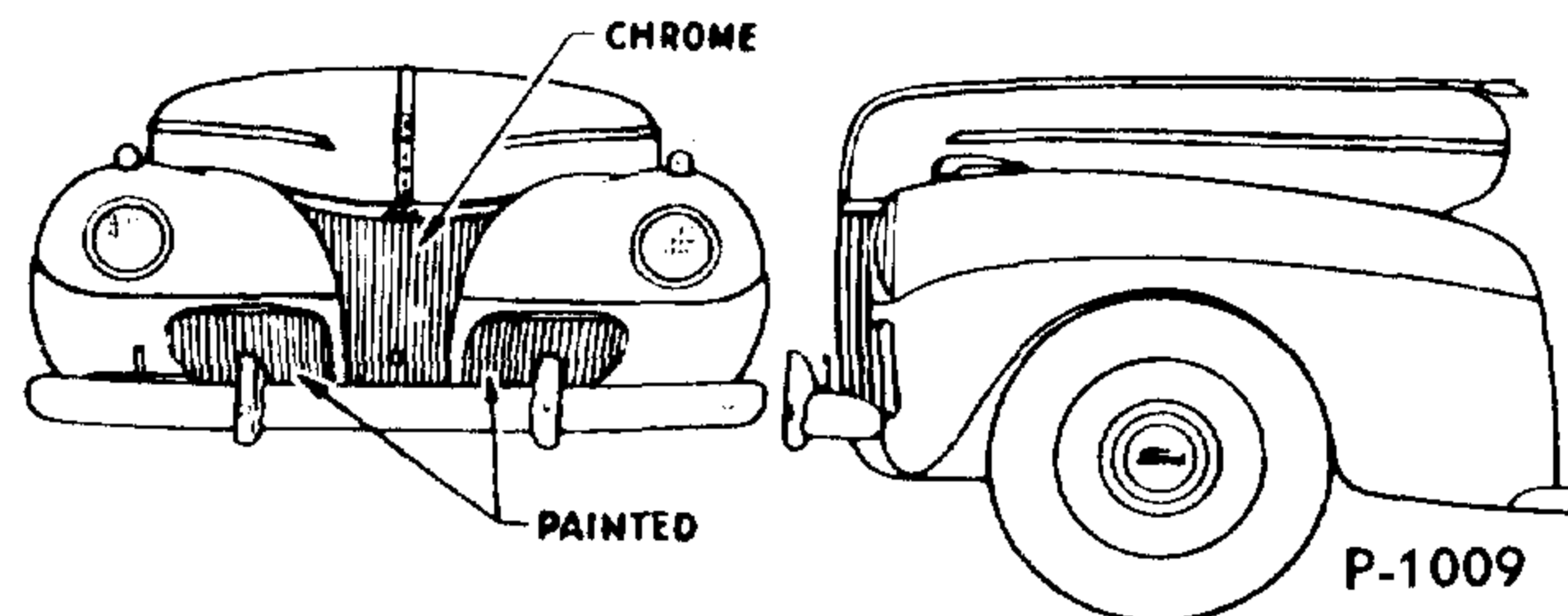

MODEL 11A FORD DELUXE
90 HP. 8-Cylinder Engine

MODEL 11A FORD SPECIAL
90 HP. 8-Cylinder Engine

MODEL 1GA FORD DELUXE
90 HP. 6-Cylinder Engine

MODEL 1GA FORD SPECIAL
90 HP. 6-Cylinder Engine
 (114" Wheelbase)

BODY TYPE	NAME	BODY TYPE	NAME
67-A	De Luxe Coupe (with auxiliary seats)	73-B	Super De Luxe Fordor Sedan
67-B	Super De Luxe Coupe (with auxiliary seats)	73-C	Special Fordor Sedan
70-A	De Luxe Tudor Sedan	76	Super De Luxe Convertible Club Coupe
70-B	Super De Luxe Tudor Sedan	77-A	De Luxe (5-Window) Coupe
70-C	Special Tudor Sedan	77-B	Super De Luxe (5-Window) Coupe
72	Super De Luxe Sedan Coupe	77-C	Special Coupe (5-Window)
73-A	De Luxe Fordor Sedan	79-A	De Luxe Station Wagon
		79-B	Super De Luxe Station Wagon

1941 FORD COMMERCIAL AND TRUCK MODELS

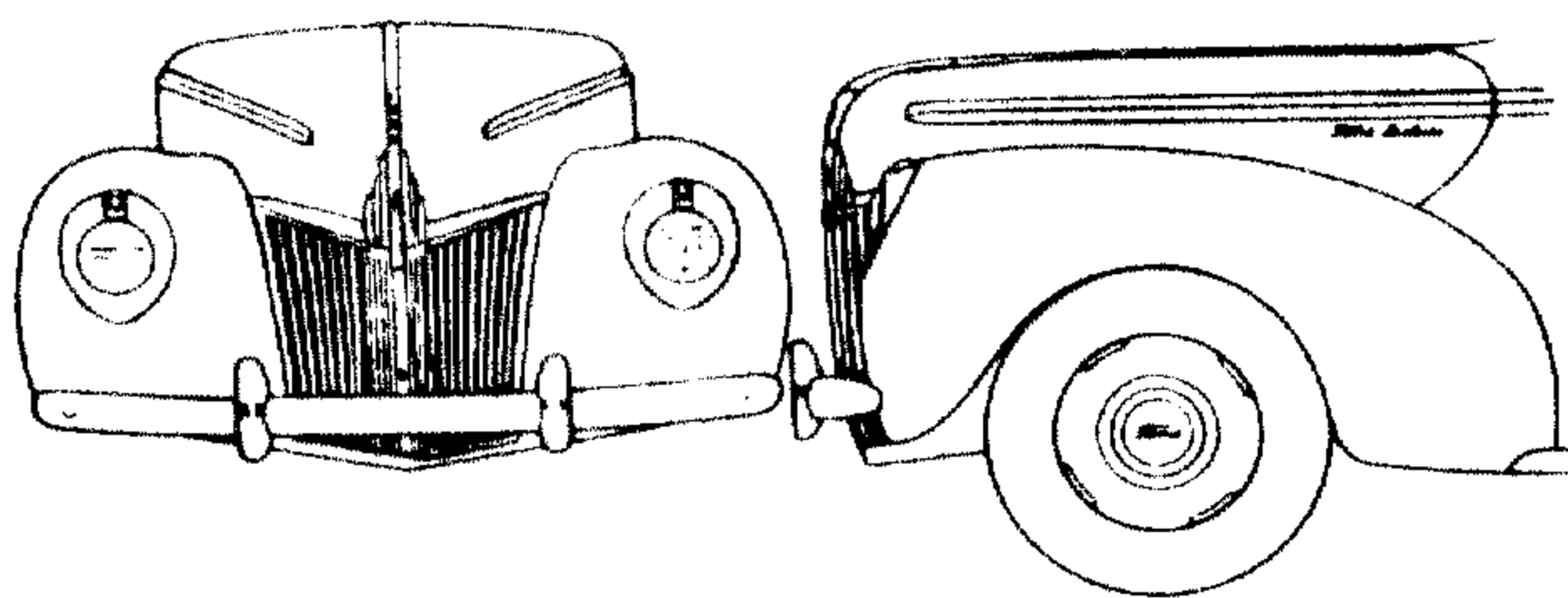

P-1010

FORD COMMERCIAL
(112" Wheelbase)

MODEL	ENGINE	HP.
11C	8 cylinder.....	90
1GC	6 cylinder.....	90
1NC	4 cylinder.....	40
19C	8 cylinder.....	100

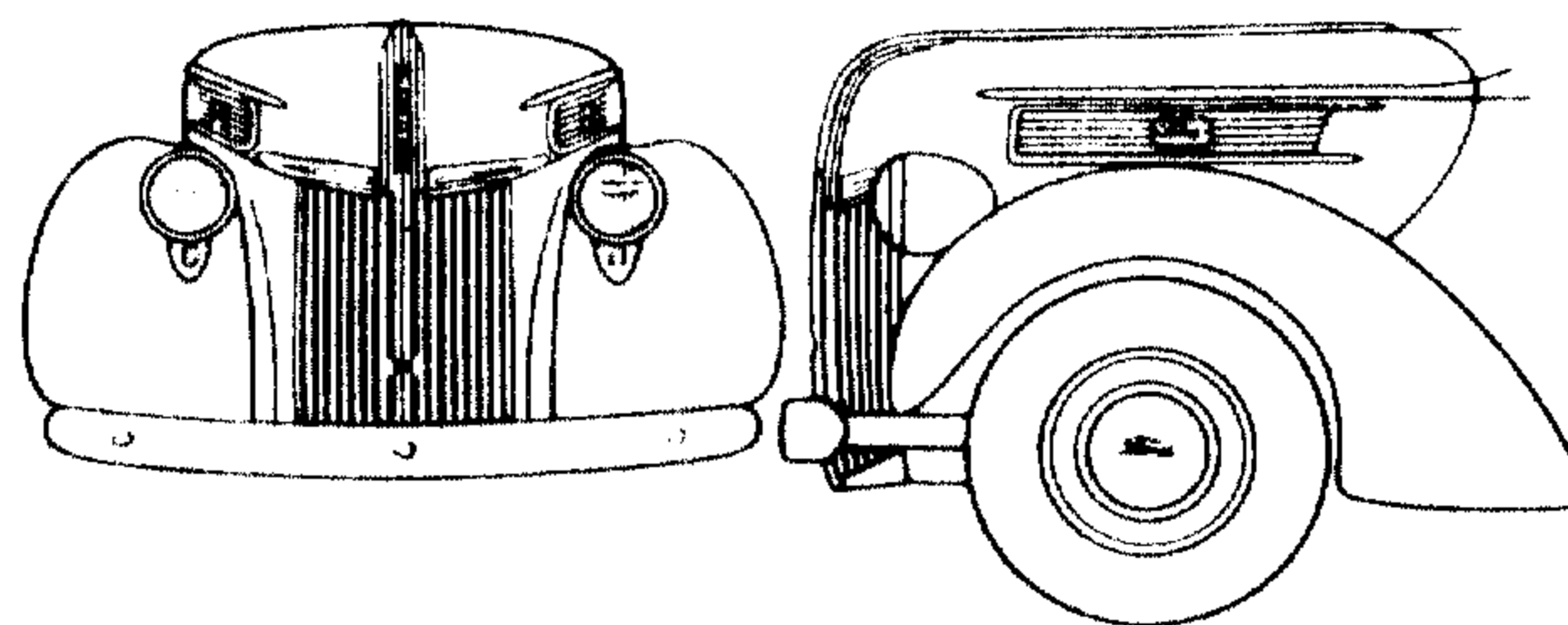

P-1011

FORD 3/4 TON TRUCK
(122" Wheelbase)

MODEL	ENGINE	HP.
11D	8 cylinder.....	90
1GD	6 cylinder.....	90
1ND	4 cylinder.....	40
19D	8 cylinder.....	100

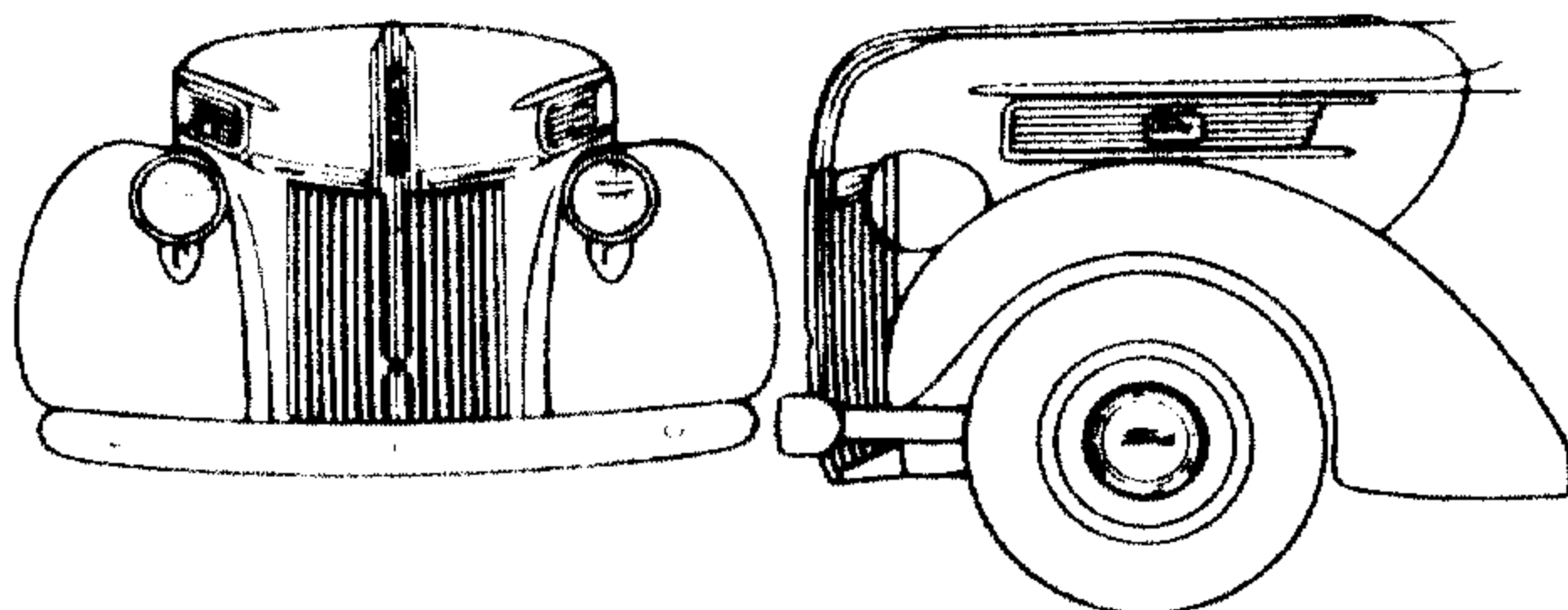

P-1012

FORD 1 TON TRUCK
(122" Wheelbase)

MODEL	ENGINE	HP.
11Y	8 cylinder.....	90
1GY	6 cylinder.....	90
1NY	4 cylinder.....	40
19Y	8 cylinder.....	100

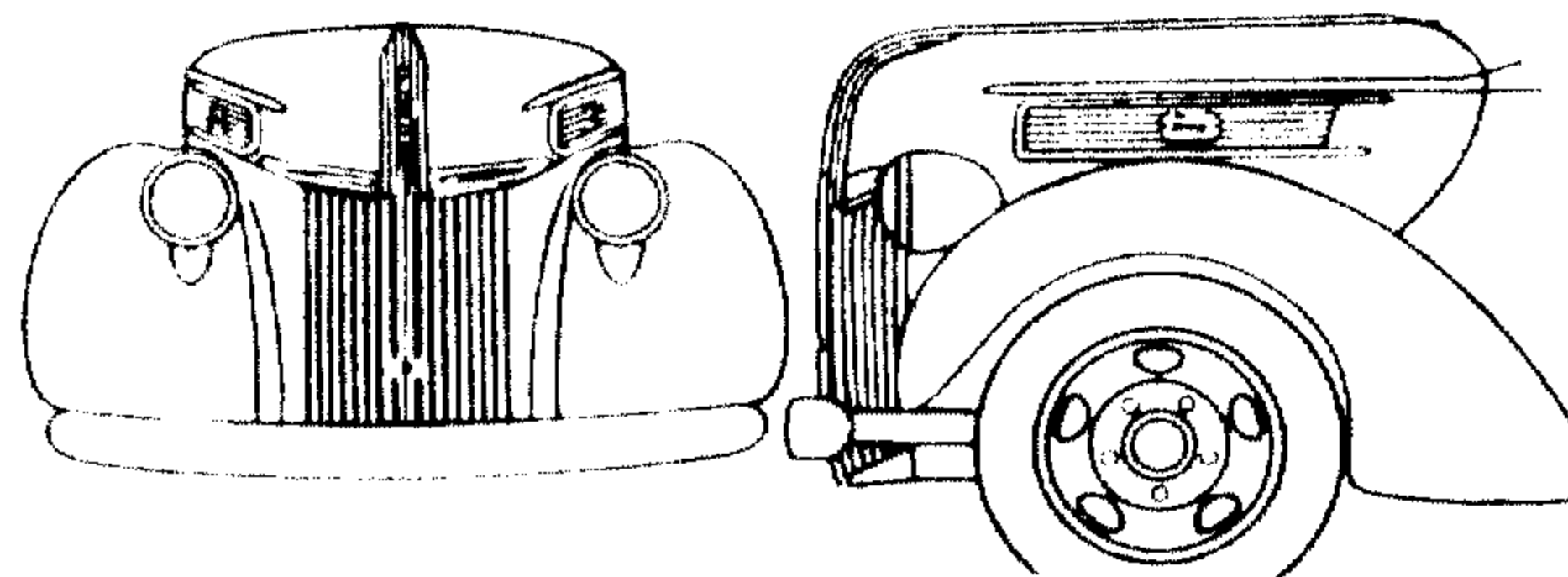

P-1013

FORD REGULAR TRUCK

MODEL and ENGINE			WHEELBASE
8 Cylinder 90 HP.	8 Cylinder 100 HP.	6 Cylinder 90 HP.	
11T	19T	1GT.....	134"
118T	198T	1G8T.....	158"
§ 11U	§ 19U	§1GU.....	134"
◇114T	◇194T	◇1G4T.....	194"
§Dump Chassis		◇School Bus Chassis	

FORD CAB-OVER-ENGINE →

MODEL and ENGINE		WHEELBASE
8 Cylinder 90 HP.	8 Cylinder 100 HP.	
111W	191W.....	101"
11W	19W.....	134"
118W	198W.....	158"

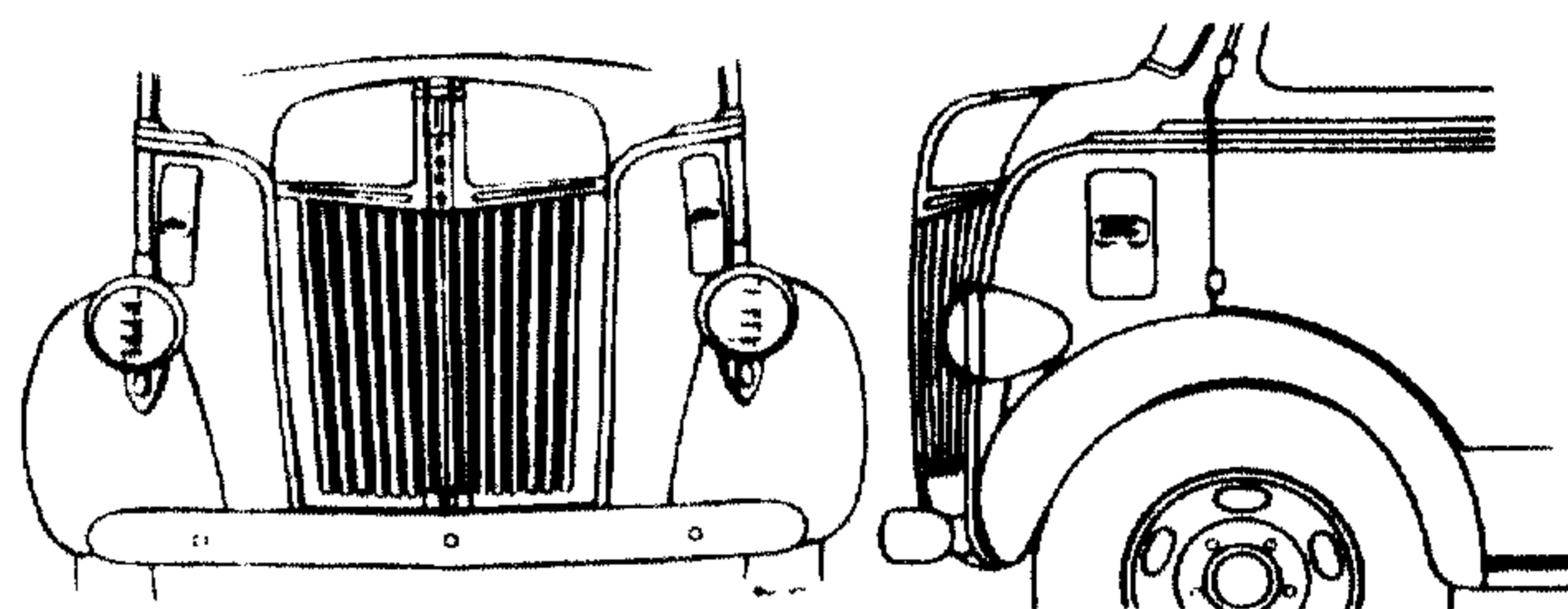

P-1014

BODY TYPE	NAME	BODY TYPE	NAME
78	Sedan Delivery (112" Wheelbase)	81	Closed Cab (101", 134", 158" Cab-Over-Engine)
80	Platform (112" Wheelbase)	82-A	Panel Delivery (with slats) (112" Wheelbase)
80	Platform (3/4 Ton) (122" Wheelbase)	82-B	Panel Delivery (with masonite) (112" Wheelbase)
80	Platform (1 Ton) (122" Wheelbase)	82	Panel Delivery (3/4 Ton) (122" Wheelbase)
80	Platform (134" Reg.) (101" Cab-Over-Engine)	82	Panel Delivery (1 Ton) (122" Wheelbase)
80	Platform (134" Cab-Over-Engine)	82	Panel Delivery (134" Wheelbase)
80	Platform (158" Wheelbase)	83	Pickup (112" Wheelbase)
81	Closed Cab (112" Wheelbase)	83	Express (3/4 Ton) (122" Wheelbase)
81	Closed Cab (122", 134", 158" Wheelbase)	83	Express (1 Ton) (122" Wheelbase)

1942

FORD PASSENGER CAR MODELS

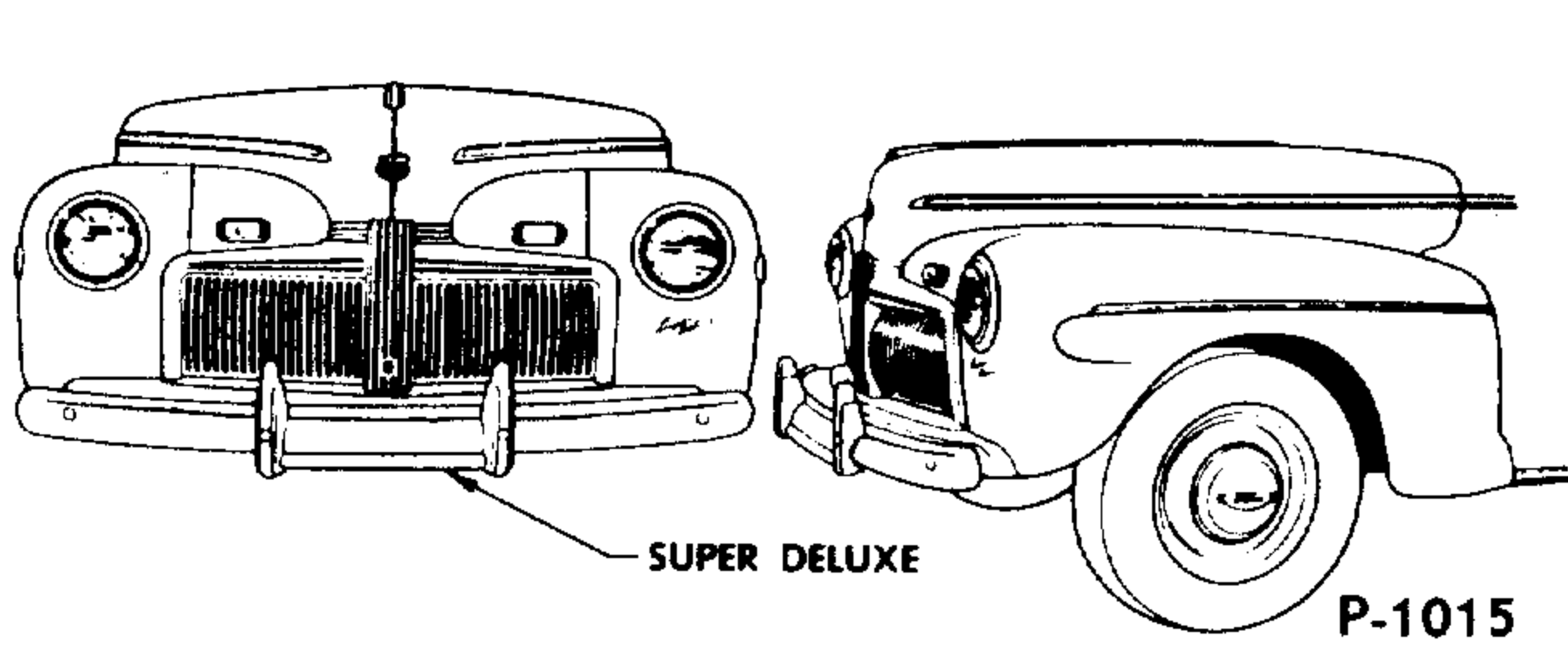

MODEL 21A FORD SUPER DELUXE
 90 HP. 8-Cylinder Engine
 (114" Wheelbase)

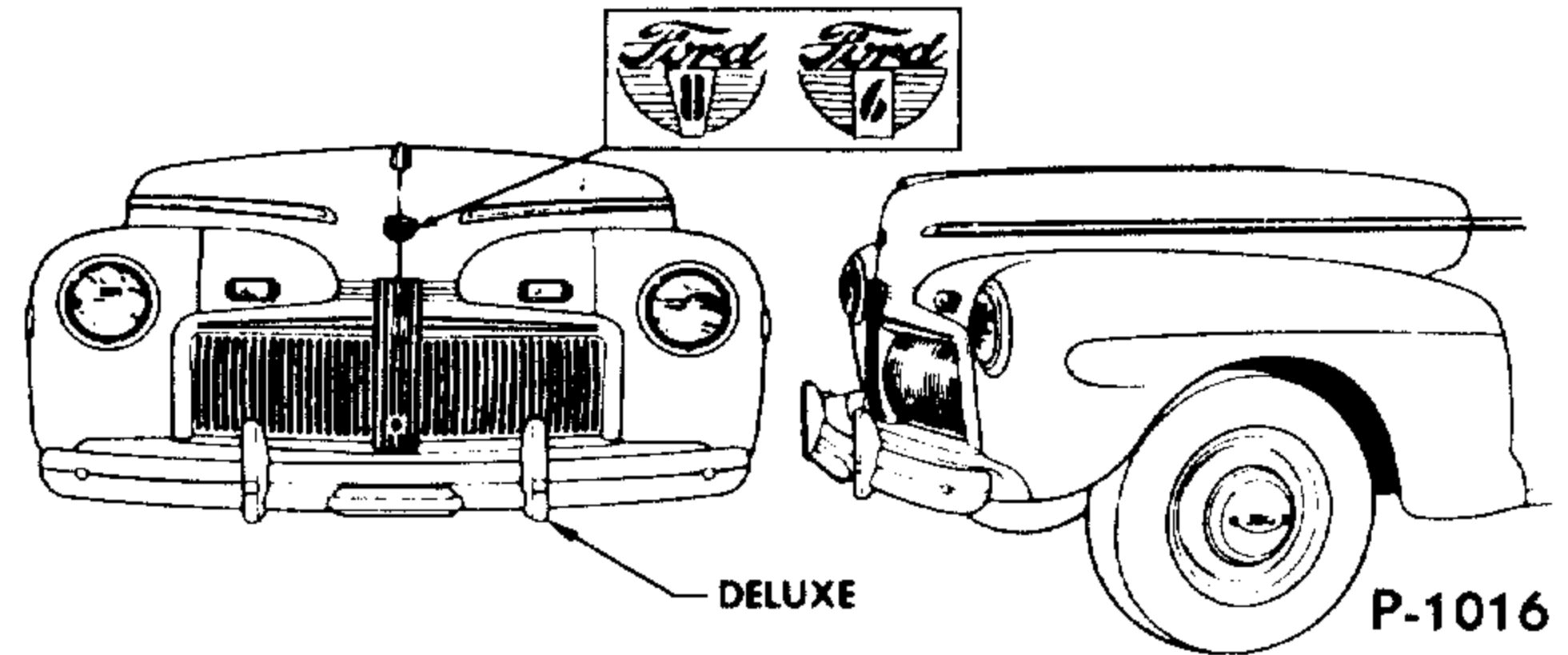

MODEL 21A FORD DELUXE
 90 HP. 8-Cylinder Engine
MODEL 2GA FORD DELUXE
 90 HP. 6-Cylinder Engine
 (114" Wheelbase)

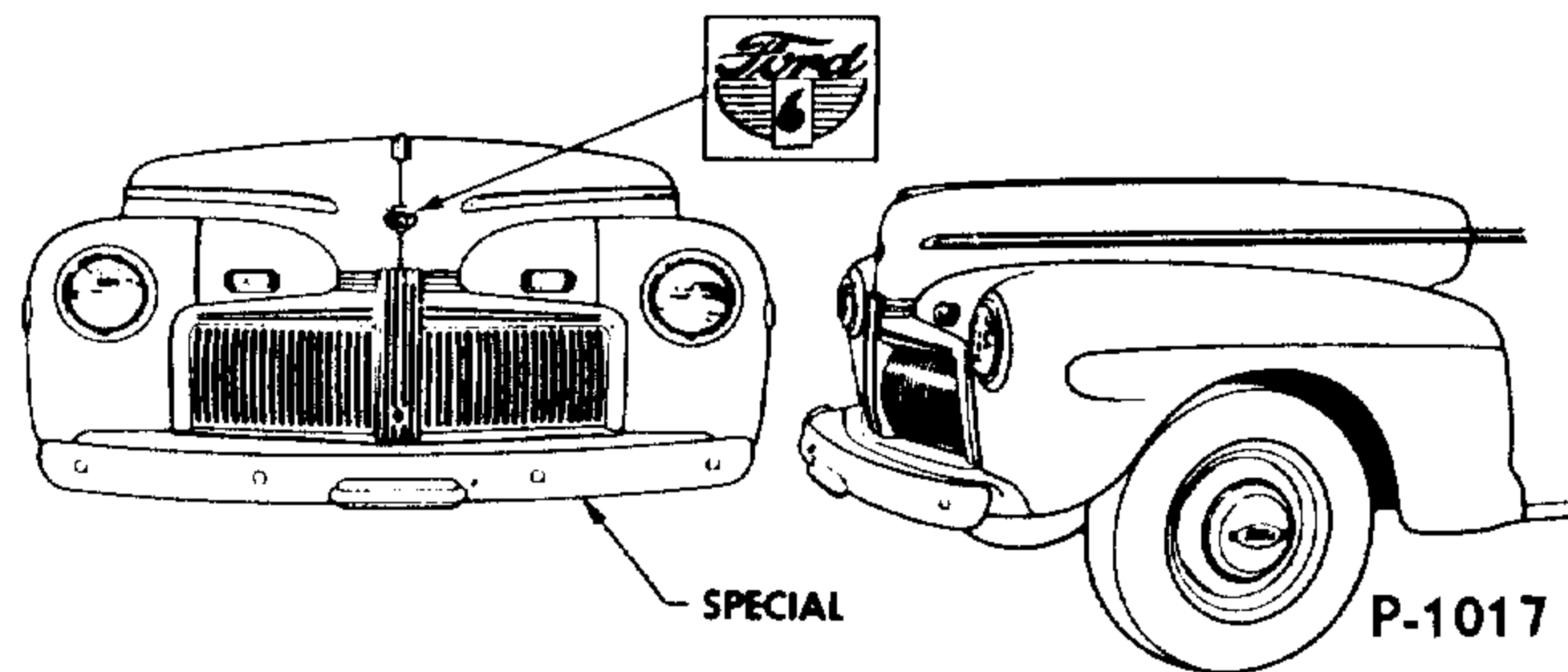

MODEL 2GA FORD SPECIAL
 90 HP. 6-Cylinder Engine
 (114" Wheelbase)

BODY TYPE	N A M E	BODY TYPE	N A M E
70-A	De Luxe Tudor Sedan	73-C	Special Fordor Sedan
70-B	Super De Luxe Tudor Sedan	76	Super De Luxe Convertible Club Coupe
70-C	Special Tudor Sedan	77-A	De Luxe (5-Window) Coupe
72-A	De Luxe Sedan Coupe	77-B	Super De Luxe (5-Window) Coupe
72-B	Super De Luxe Sedan Coupe	77-C	Special Coupe (5-Window)
73-A	De Luxe Fordor Sedan	78	De Luxe Sedan Delivery
73-B	Super De Luxe Fordor Sedan	79-B	Super De Luxe Station Wagon

1942 FORD COMMERCIAL AND TRUCK MODELS

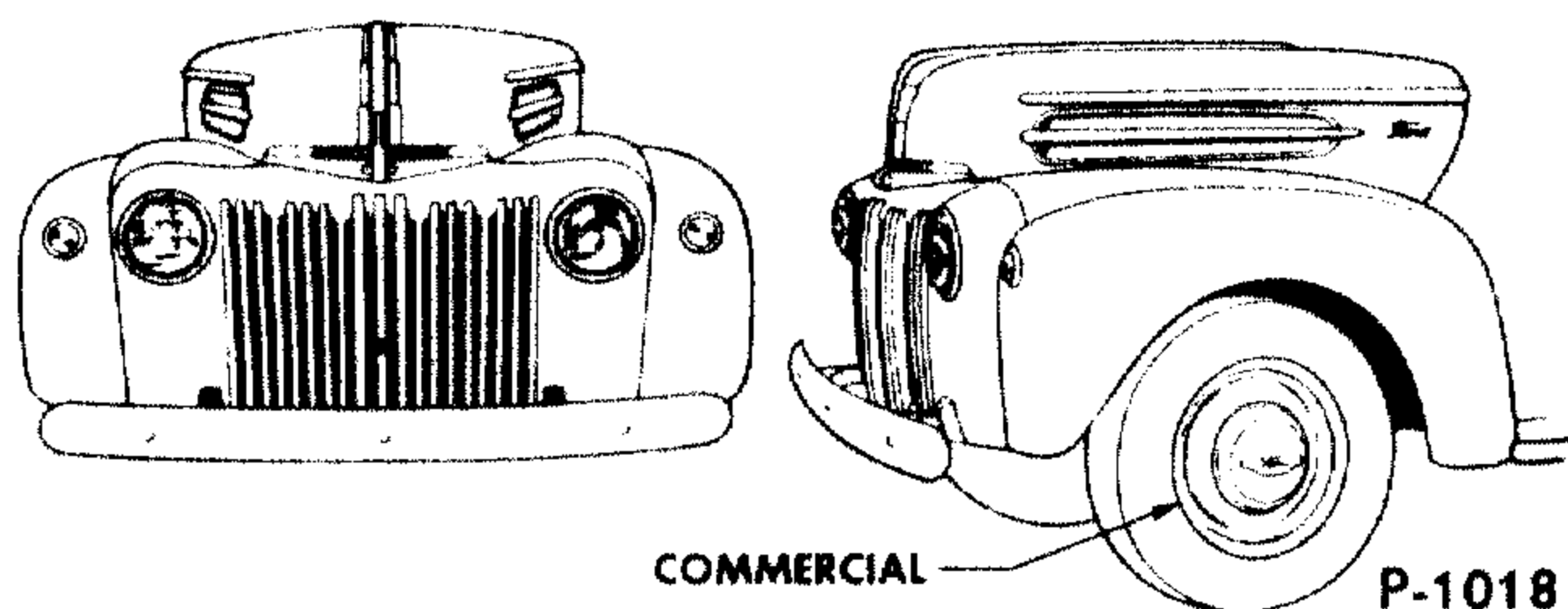

COMMERCIAL P-1018

FORD COMMERCIAL OR LIGHT TRUCK (114" Wheelbase)

MODEL	ENGINE	HP.
29C	8 cylinder.....	100
21C	8 cylinder.....	90
2GC	6 cylinder.....	90
2NC	4 cylinder.....	40

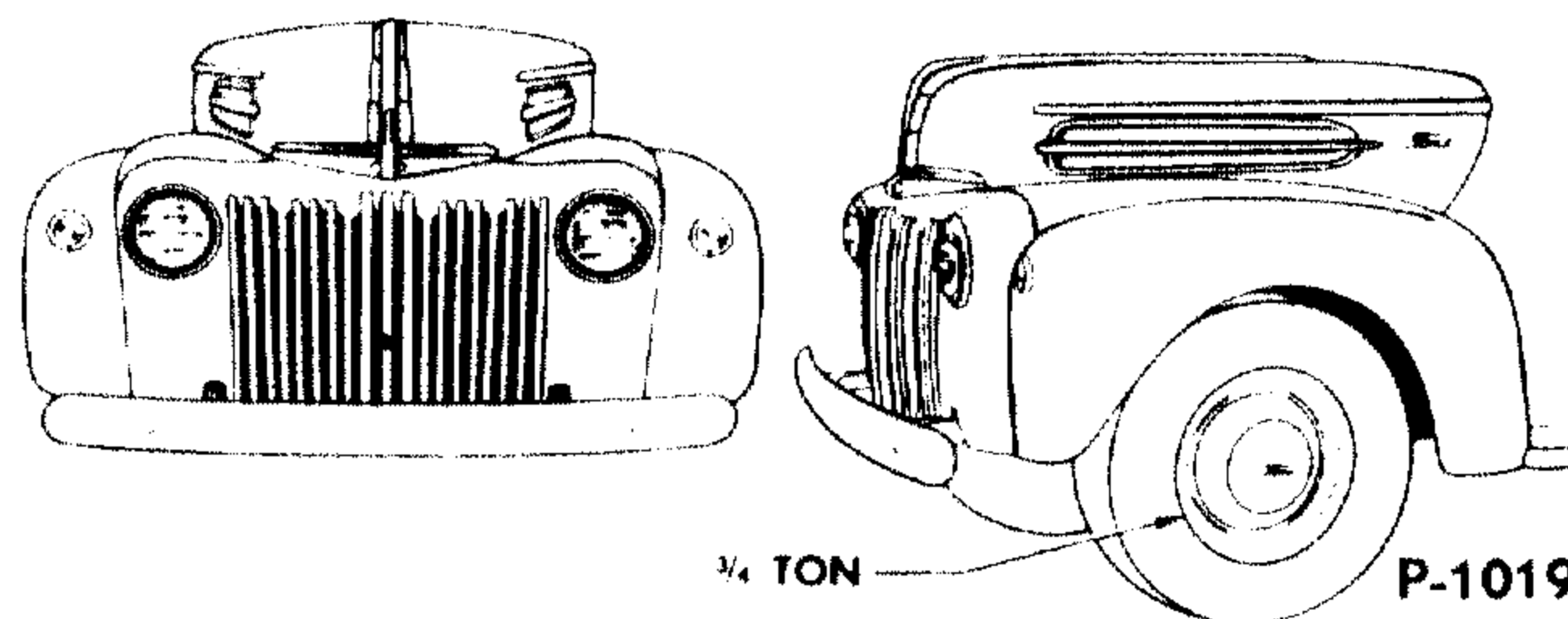

3/4 TON P-1019

FORD 3/4 TON TRUCK (122" Wheelbase)

MODEL	ENGINE	HP.
29D	8 cylinder.....	100
21D	8 cylinder.....	90
2GD	6 cylinder.....	90
2ND	4 cylinder.....	40

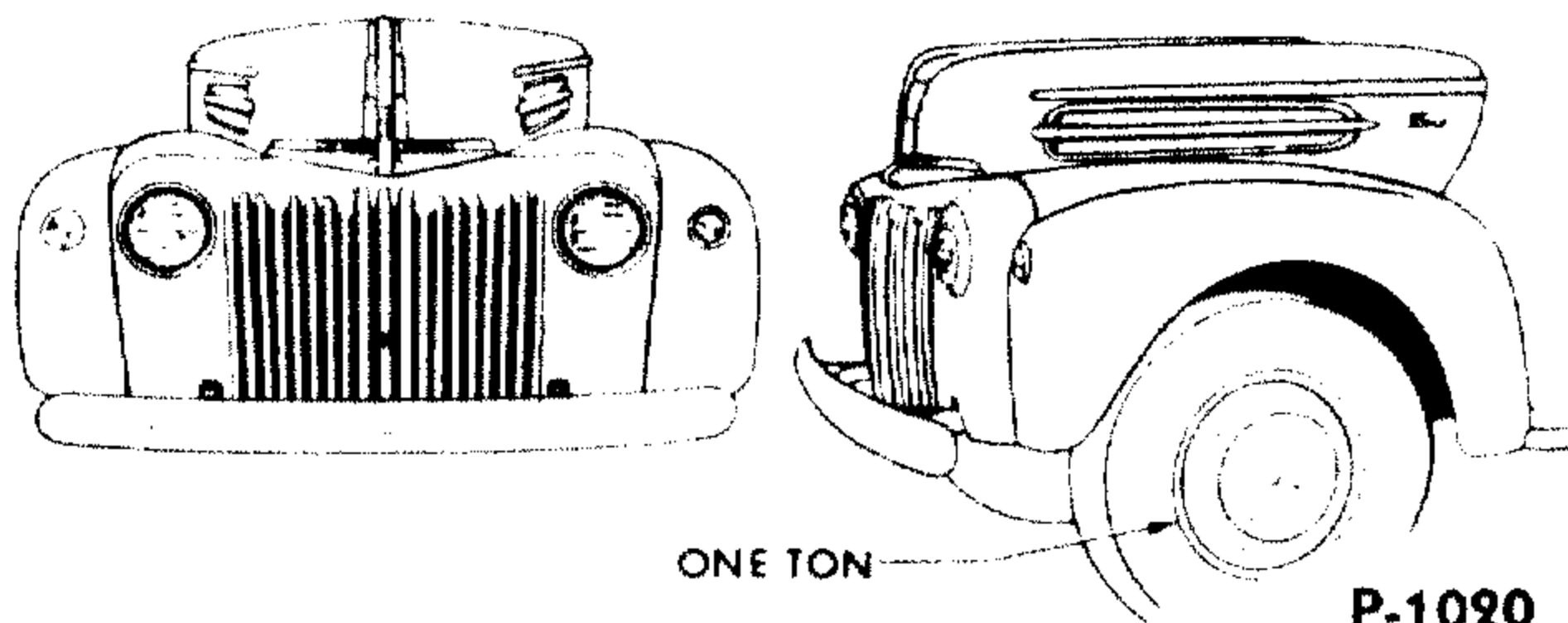

ONE TON P-1020

FORD 1 TON TRUCK (122" Wheelbase)

MODEL	ENGINE	HP.
21Y	8 cylinder.....	90
2GY	6 cylinder.....	90
2NY	4 cylinder.....	40
29Y	8 cylinder.....	100

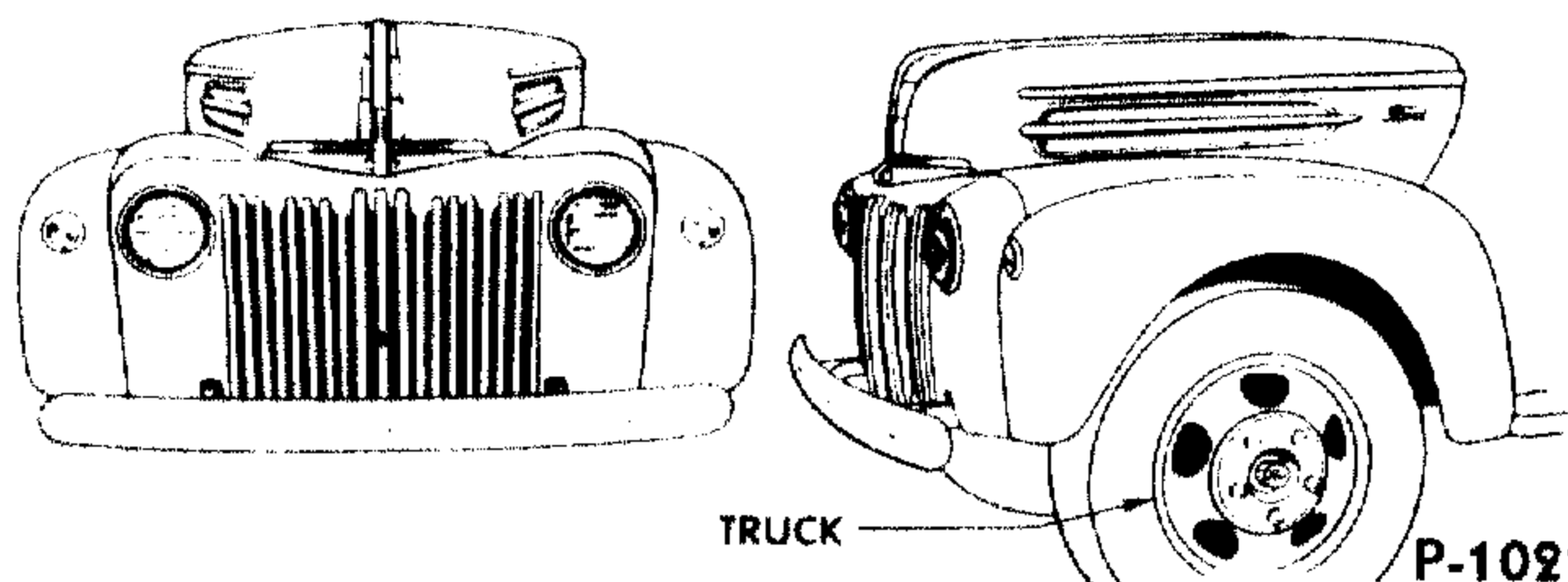

TRUCK P-1021

FORD REGULAR TRUCK

MODEL and ENGINE			WHEELBASE
8 Cylinder 90 HP.	8 Cylinder 100 HP.	6 Cylinder 90 HP.	
21T	29T	2GT	134"
218T	298T	2G8T	158"
§ 21U	§ 29U	§ 2GU	134"
◇ 294T	◇ 294T	◇ 2G4T	194"
§ Dump Chassis		◇ School Bus Chassis	

FORD CAB-OVER-ENGINE →

MODEL and ENGINE		WHEELBASE
8 Cylinder 90 HP.	8 Cylinder 100 HP.	
211W	291W	101"
21W	29W	134"
218W	298W	158"

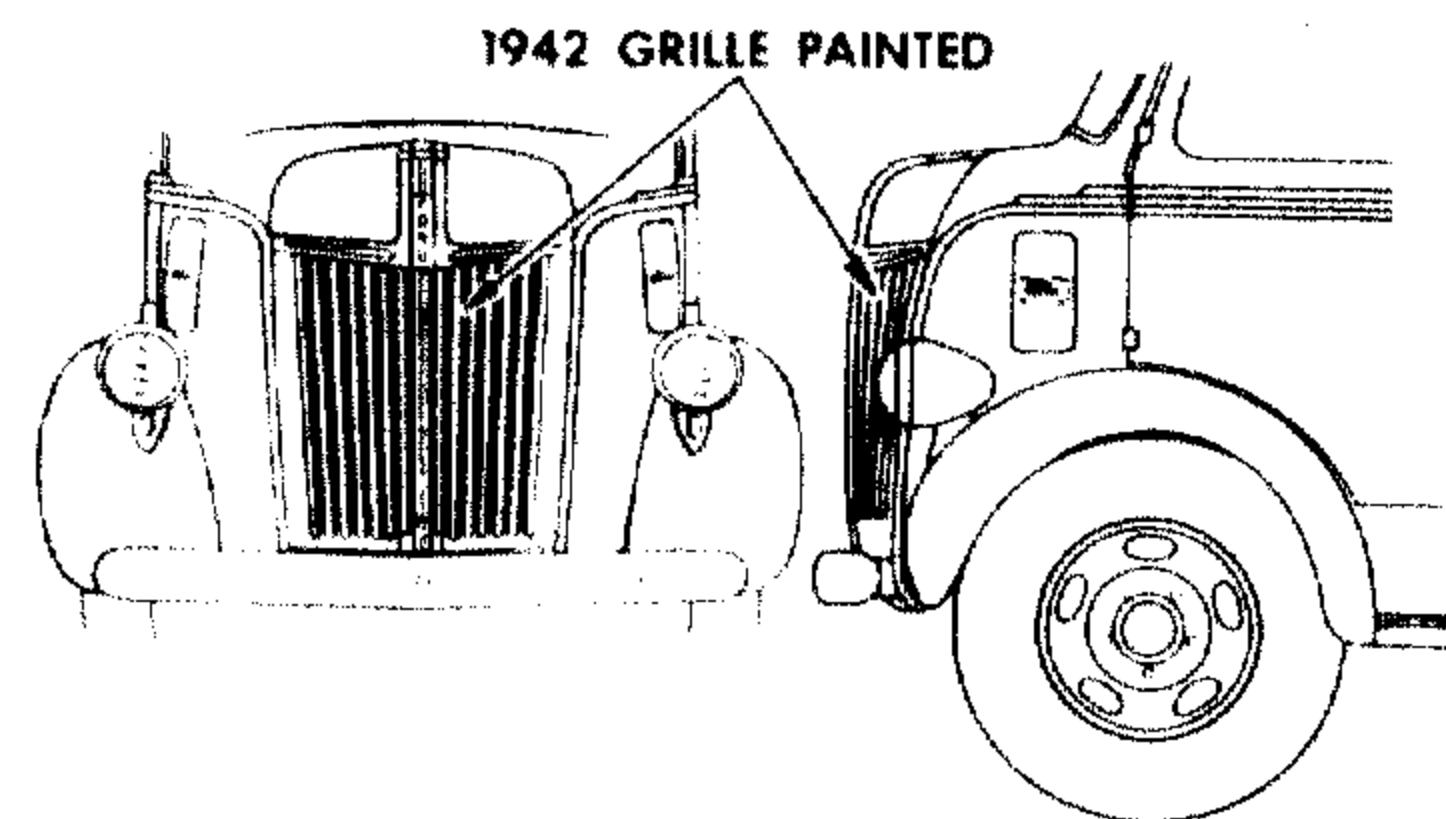

1942 GRILLE PAINTED

P-1022

BODY TYPE	NAME	BODY TYPE	NAME
80	Platform (114" Wheelbase)	82-A	Panel Delivery (with slats) (114" Wheelbase)
80	Platform (3/4 Ton) (122" Wheelbase)	82-B	Panel Delivery (with masonite) (114" Wheelbase)
80	Platform (1 Ton) (122" Wheelbase)	82	Panel Delivery (3/4 Ton) (122" Wheelbase)
80	Platform (134" Regular and 101" Cab-Over-Engine)	82	Panel Delivery (1 Ton) (122" Wheelbase)
80	Platform (134" Cab-Over-Engine)	82	Panel Delivery (134" Wheelbase)
80	Platform (158" Wheelbase)	83	Pickup (114" Wheelbase)
81	Closed Cab (114" Wheelbase)	83	Express (3/4 Ton) (122" Wheelbase)
81	Closed Cab (122", 134", 158" Wheelbase)	83	Express (1 Ton) (122" Wheelbase)
81	Closed Cab (101", 134", 158" Cab-Over-Engine)		

1943

NO CIVILIAN PASSENGER CARS OR TRUCKS WERE
MANUFACTURED DURING THE YEAR 1943.

1944

FORD TRUCK MODELS

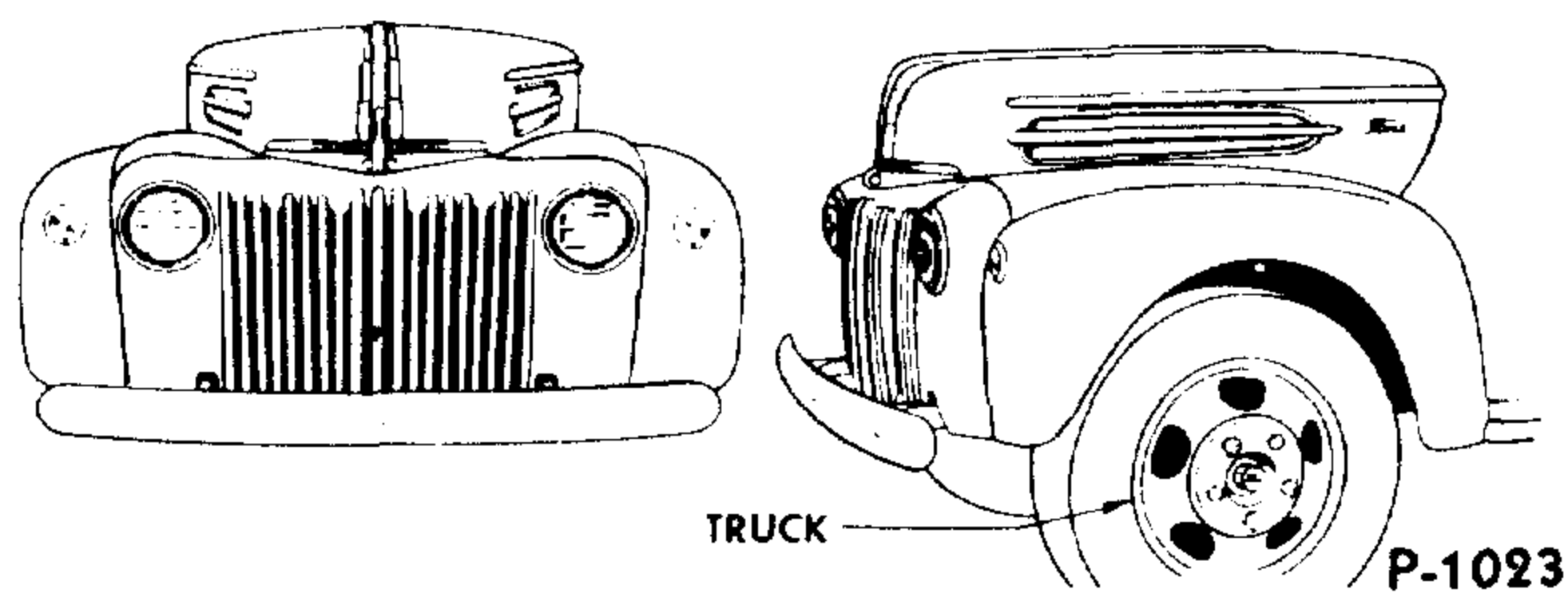

FORD REGULAR TRUCK

MODEL		WHEELBASE
498T	8 cylinder, 100 HP.....	158"
◇494T	8 cylinder, 100 HP.....	194"
◇School Bus	Chassis	

BODY TYPE	NAME
81	Closed Cab (158" Wheelbase)

1945

FORD COMMERCIAL AND TRUCK MODELS

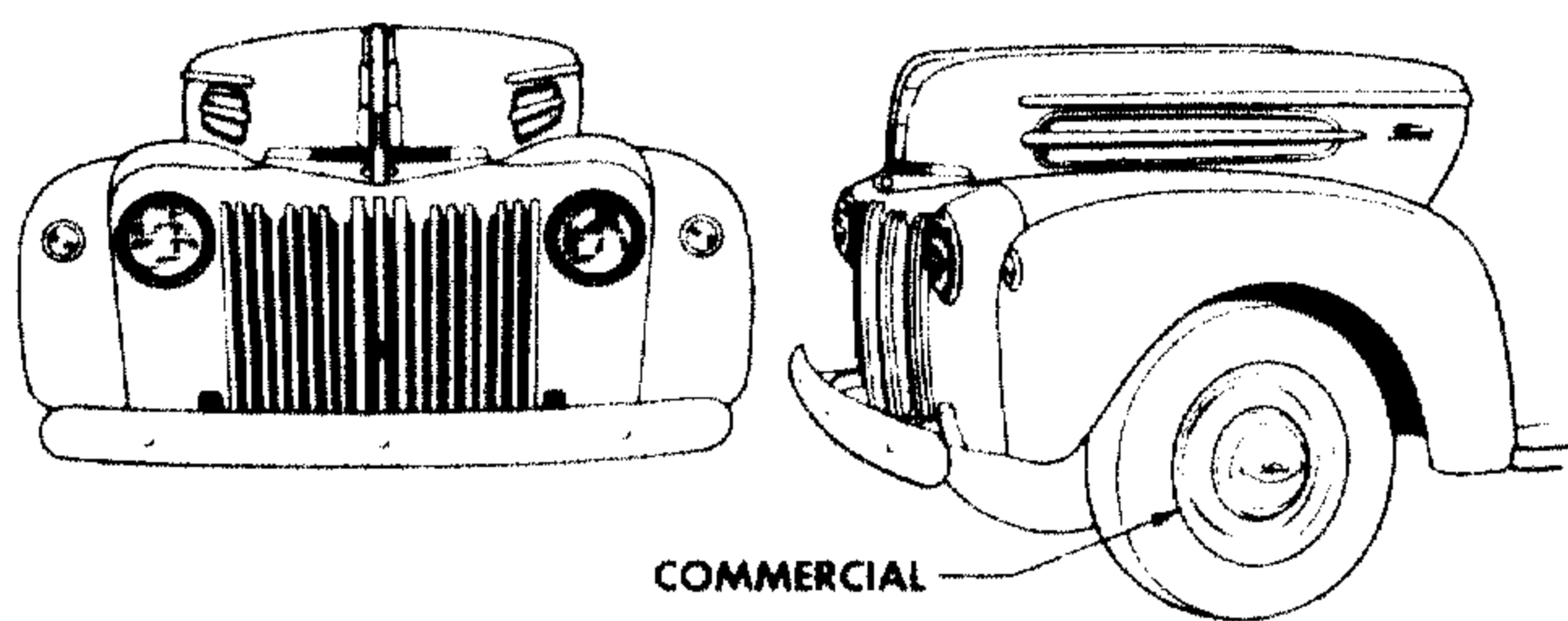

COMMERCIAL

P-1024

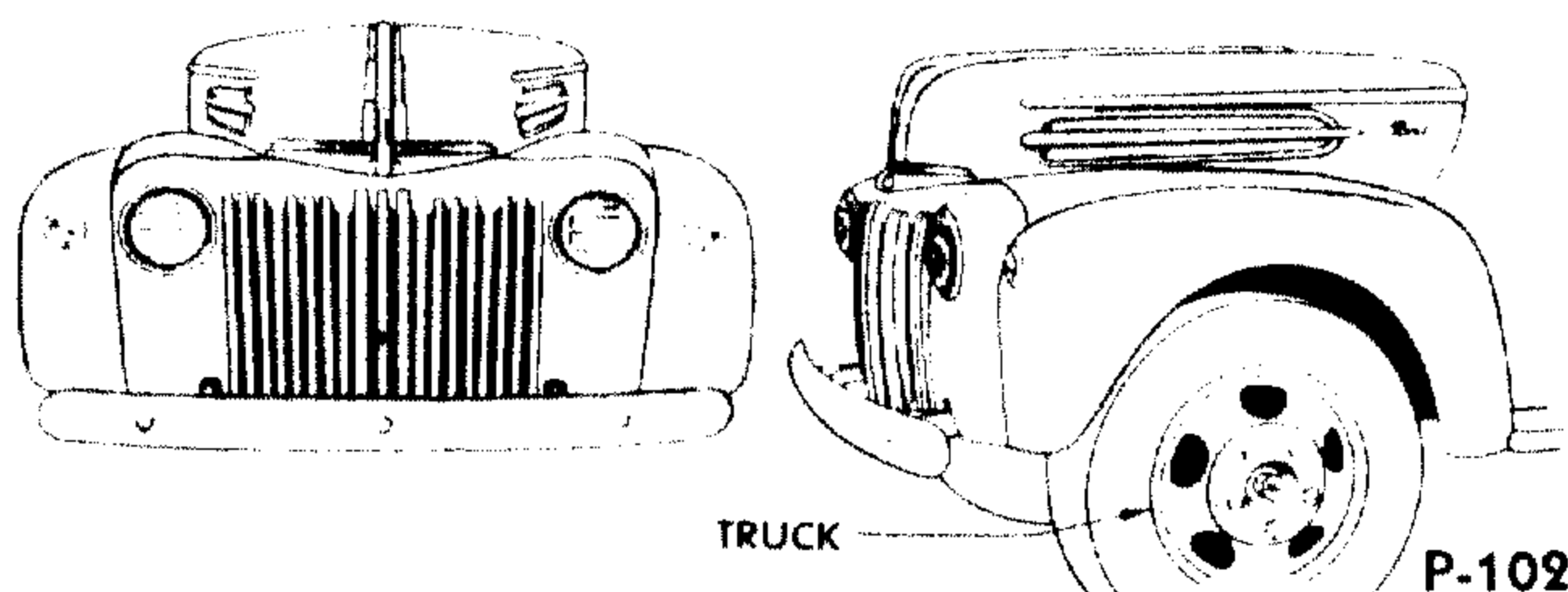

TRUCK

P-1025

FORD COMMERCIAL OR LIGHT TRUCK (114" Wheelbase)

MODEL	ENGINE	HP.
59C	8 cylinder	100

FORD REGULAR TRUCK

MODEL and ENGINE	WHEELBASE
59T 8 cylinder 100 HP.	134"
598T 8 cylinder 100 HP.	158"
594T 8 cylinder 100 HP.	194"
School Bus Chassis	

BODY TYPE	NAME	BODY TYPE	NAME
80	Platform (114" Wheelbase)	81	Closed Cab (134" Wheelbase)
80	Platform (134" Wheelbase)	81	Closed Cab (158" Wheelbase)
80	Platform (158" Wheelbase)	82-A	Panel Delivery (with slats) (114" Wheelbase)
81	Closed Cab (114" Wheelbase)	83	Pickup (114" Wheelbase)



1946

FORD PASSENGER CAR MODELS

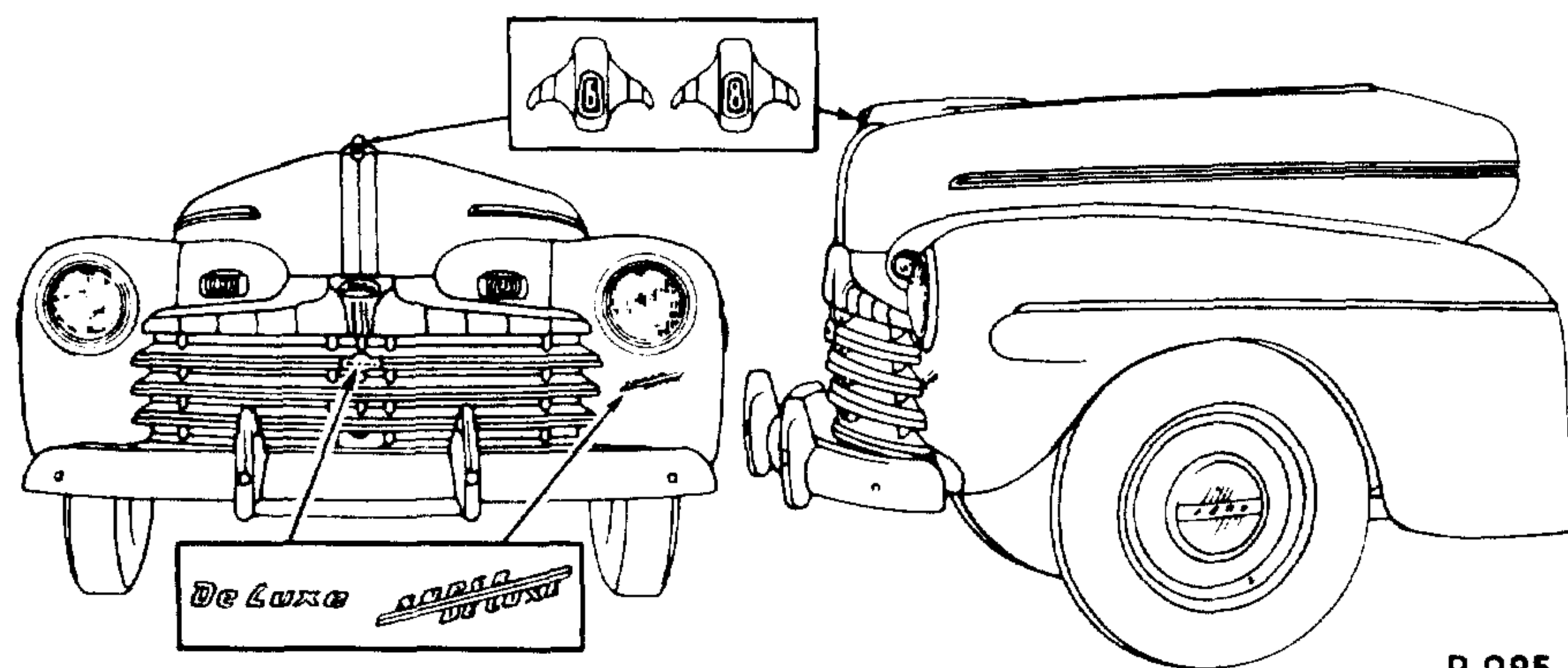

P-925

MODEL 69A FORD DELUXE OR SUPER DELUXE—100 HP. 8-Cylinder Engine

MODEL 6GA FORD DELUXE OR SUPER DELUXE—90 HP. 6-Cylinder Engine

(114" Wheelbase)

BODY TYPE	NAME	BODY TYPE	NAME
70-A	De Luxe Tudor Sedan	76	Super De Luxe Convertible Club Coupe
70-B	Super De Luxe Tudor Sedan	77-A	De Luxe (5-Window) Coupe
71	Sportsman Coupe	77-B	Super De Luxe (5-Window) Coupe
72-B	Super De Luxe Sedan Coupe	78	De Luxe Sedan Delivery
73-A	De Luxe Fordor Sedan	79-B	Super De Luxe Station Wagon
73-B	Super De Luxe Fordor Sedan		



1946

FORD COMMERCIAL AND TRUCK MODELS

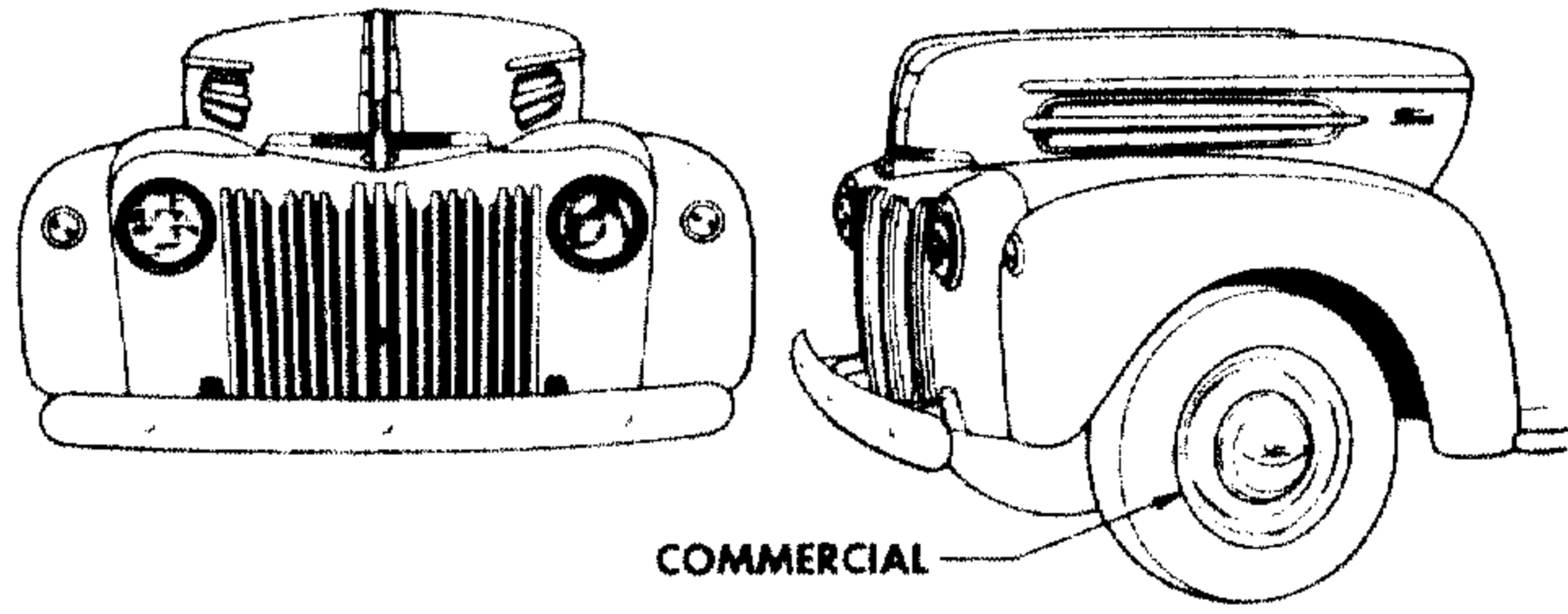

P-1026

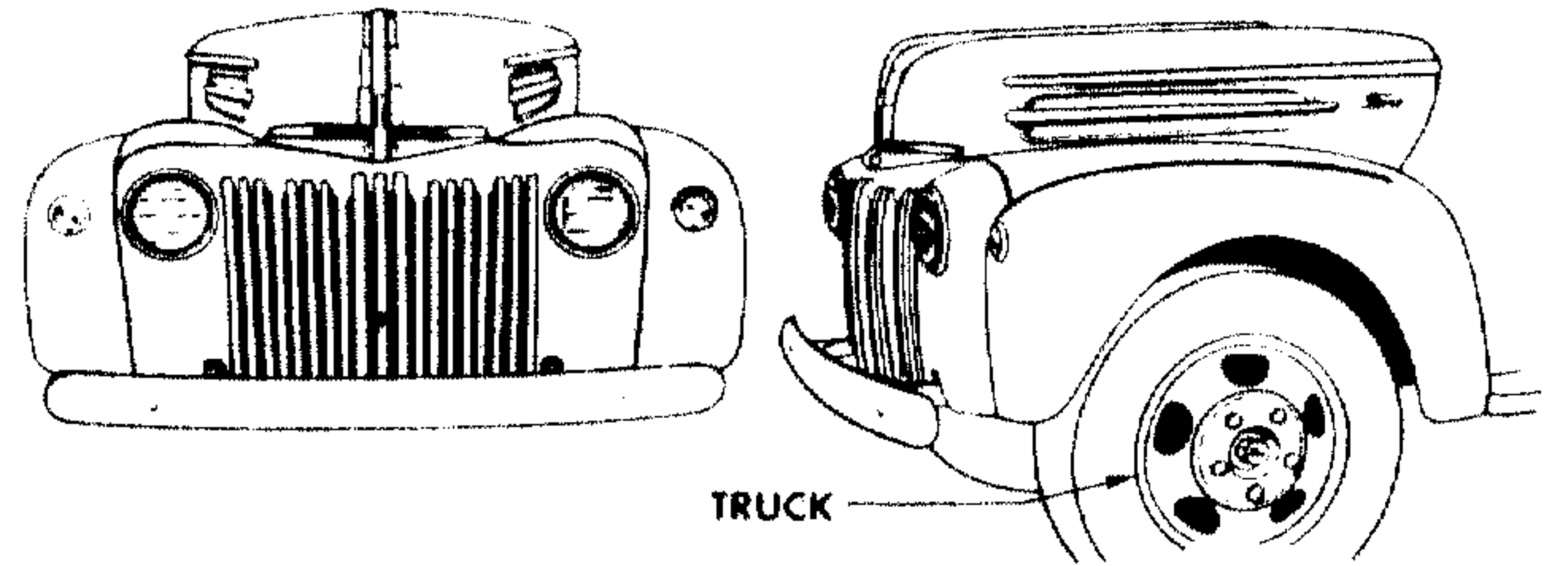

P-1028

FORD COMMERCIAL OR LIGHT TRUCK (114" Wheelbase)

MODEL	ENGINE	HP.
69C	8 cylinder	100
6GC	6 cylinder	90

FORD REGULAR TRUCK

MODEL and ENGINE		WHEELBASE
8 Cylinder 100 HP.	6 Cylinder 90 HP.	
69T	6GT	134"
698T	6G8T	158"
§ 69U	§6GU	134"
694T		194"

§Dump Chassis
⊙School Bus Chassis

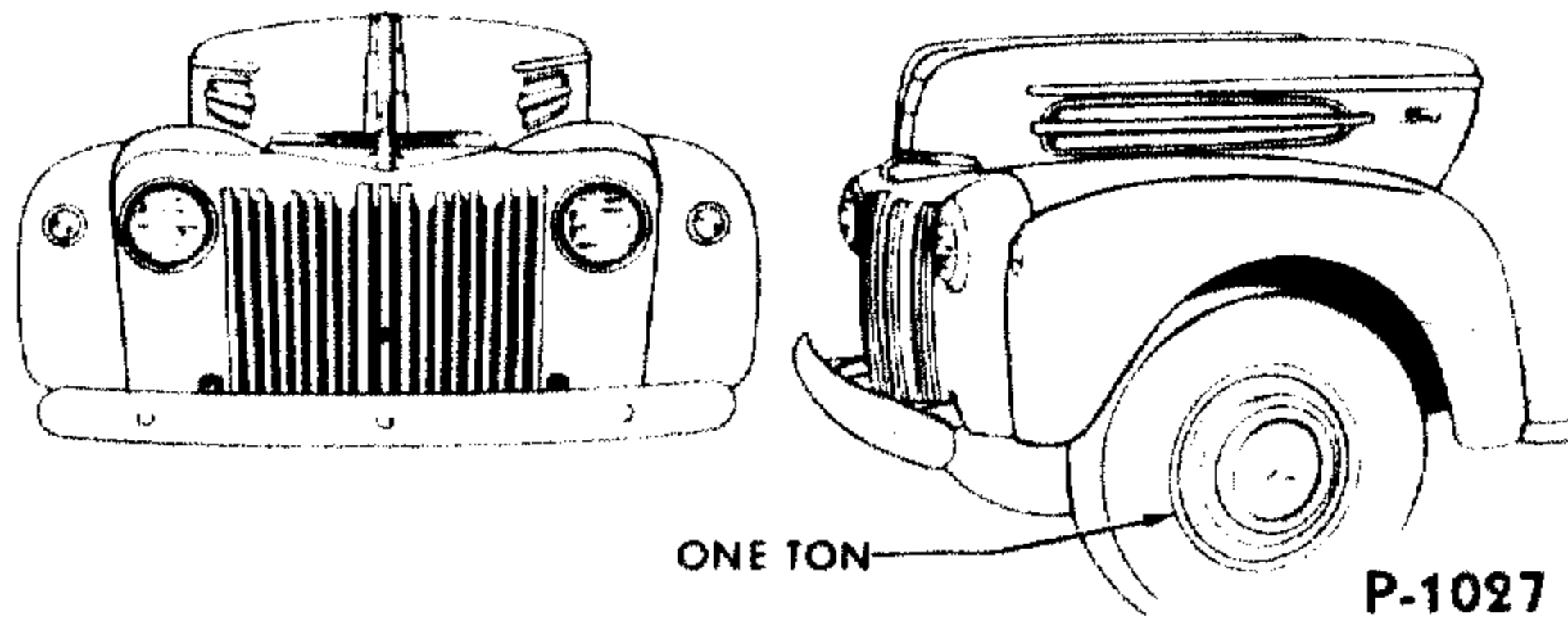

P-1027

FORD 1 TON TRUCK (122" Wheelbase)

MODEL	ENGINE	HP.
69Y	8 cylinder	100
6GY	6 cylinder	90

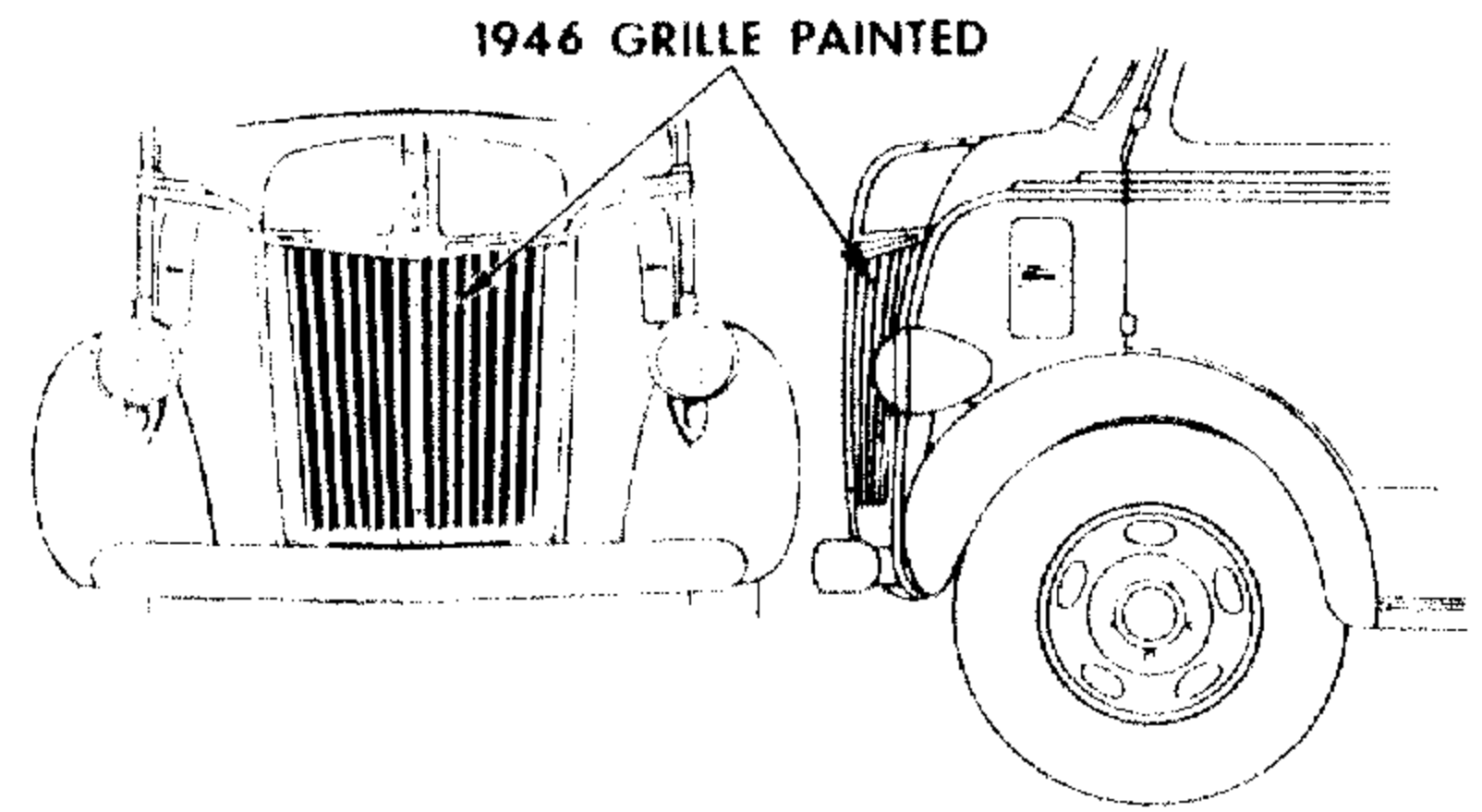

P-1029

FORD CAB-OVER-ENGINE

MODEL and ENGINE		WHEELBASE
8 Cylinder 100 HP.		
691W		101"
69W		134"
698W		158"

BODY TYPE	NAME	BODY TYPE	NAME
80	Platform (114" Wheelbase)	81	Closed Cab (122", 134", 158" Wheelbase)
80	Platform (1 Ton) (122" Wheelbase)	81	Closed Cab (101", 134", 158" Cab-Over-Engine)
80	Platform (134" Regular and 101" Cab-Over-Engine)	82-A	Panel Delivery (with slats) (114" Wheelbase)
80	Platform (134" Cab-Over-Engine)	82	Panel Delivery (1 Ton) (122" Wheelbase)
80	Platform (158" Wheelbase)	83	Pickup (114" Wheelbase)
81	Closed Cab (114" Wheelbase)	83	Express (1 Ton) (122" Wheelbase)

1947

FORD PASSENGER CAR MODELS

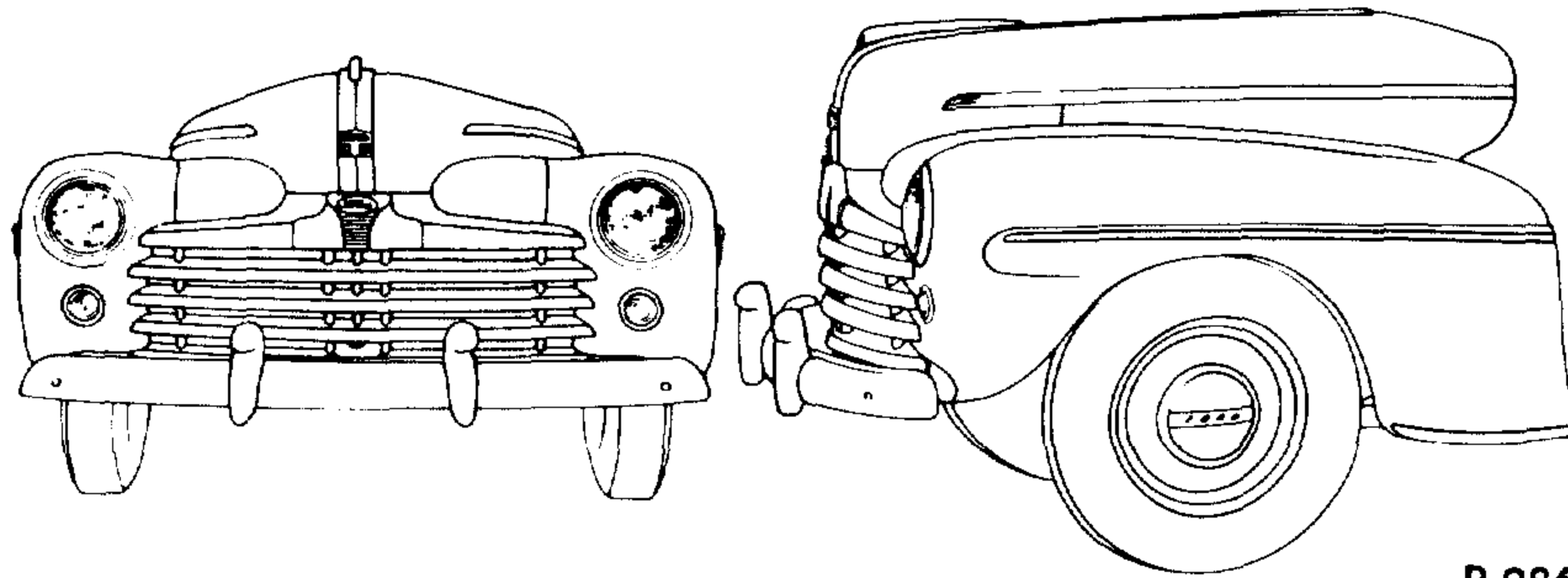

P-926

MODEL 79A FORD DELUXE OR SUPER DELUXE—100 HP. 8-Cylinder Engine

MODEL 7GA FORD DELUXE OR SUPER DELUXE—90 HP. 6-Cylinder Engine

**MODEL 7HA FORD DELUXE OR SUPER DELUXE—95 HP. 6-Cylinder Engine
(114" Wheelbase)**

BODY TYPE	N A M E	BODY TYPE	N A M E
70-A	De Luxe Tudor Sedan	76	Super De Luxe Convertible Club Coupe
70-B	Super De Luxe Tudor Sedan	77-A	De Luxe (5-Window) Coupe
71	Sportsman Coupe	77-B	Super De Luxe (5-Window) Coupe
72-B	Super De Luxe Sedan Coupe	78	De Luxe Sedan Delivery
73-A	De Luxe Fordor Sedan	79-B	Super De Luxe Station Wagon
73-B	Super De Luxe Fordor Sedan		



1947

FORD COMMERCIAL AND TRUCK MODELS

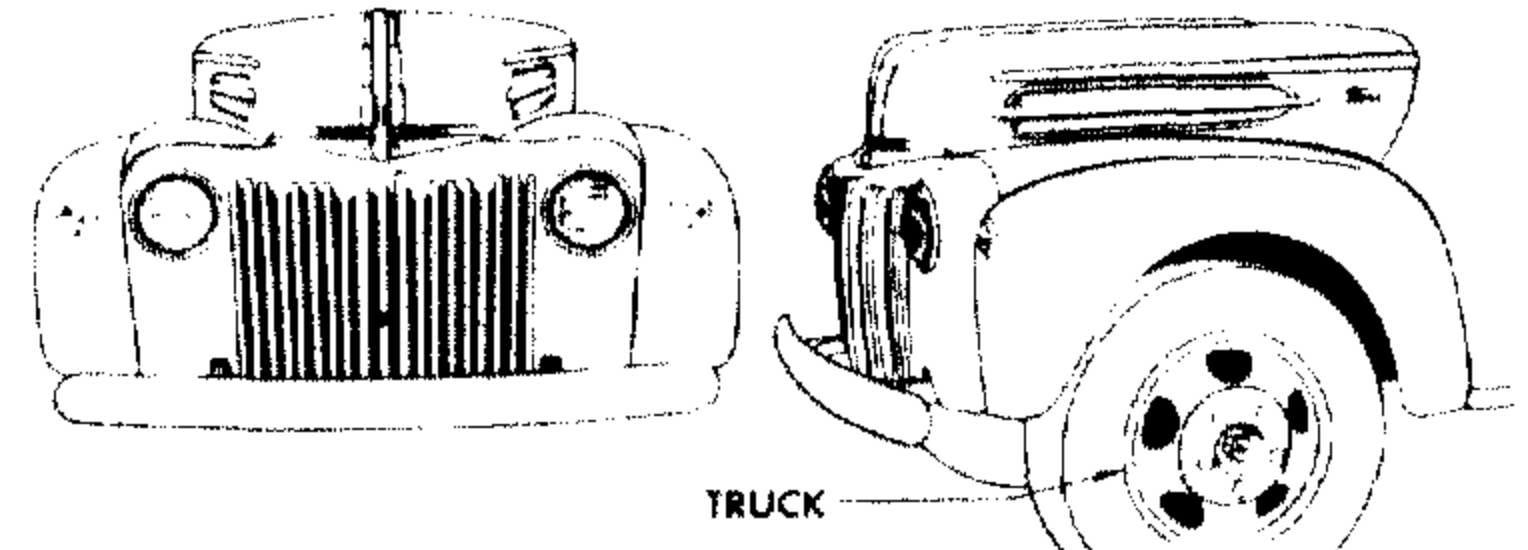
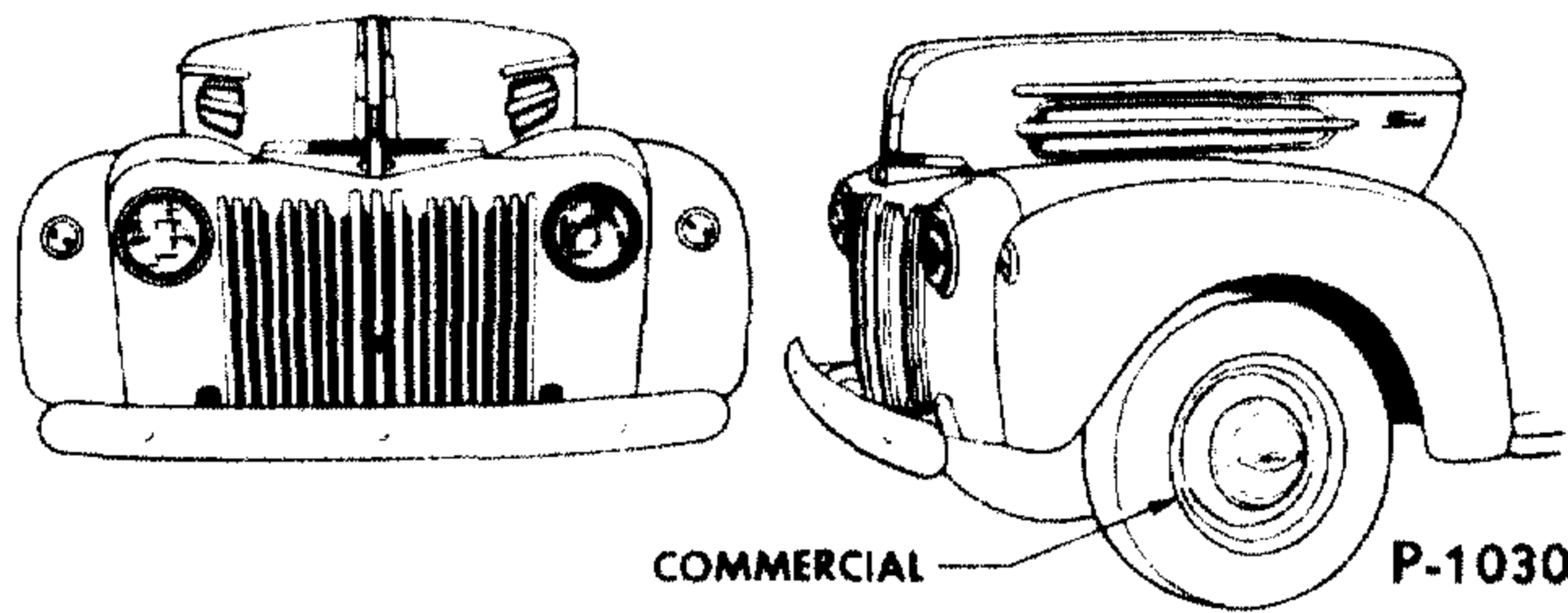

FORD COMMERCIAL OR LIGHT TRUCK

MODEL	ENGINE	HP.
79C	8 cylinder.....	100
7GC	6 cylinder.....	90
7HC	6 cylinder.....	95

FORD REGULAR TRUCK

MODEL	8 Cylinder 100 HP.	6 Cylinder 90 HP.	6 Cylinder 95 HP.	WHEELBASE
79T		7GT	7HT.....	134"
798T		768T	7H8T.....	158"
794T		7G4T	7H4T.....	194"

• School Bus Chassis

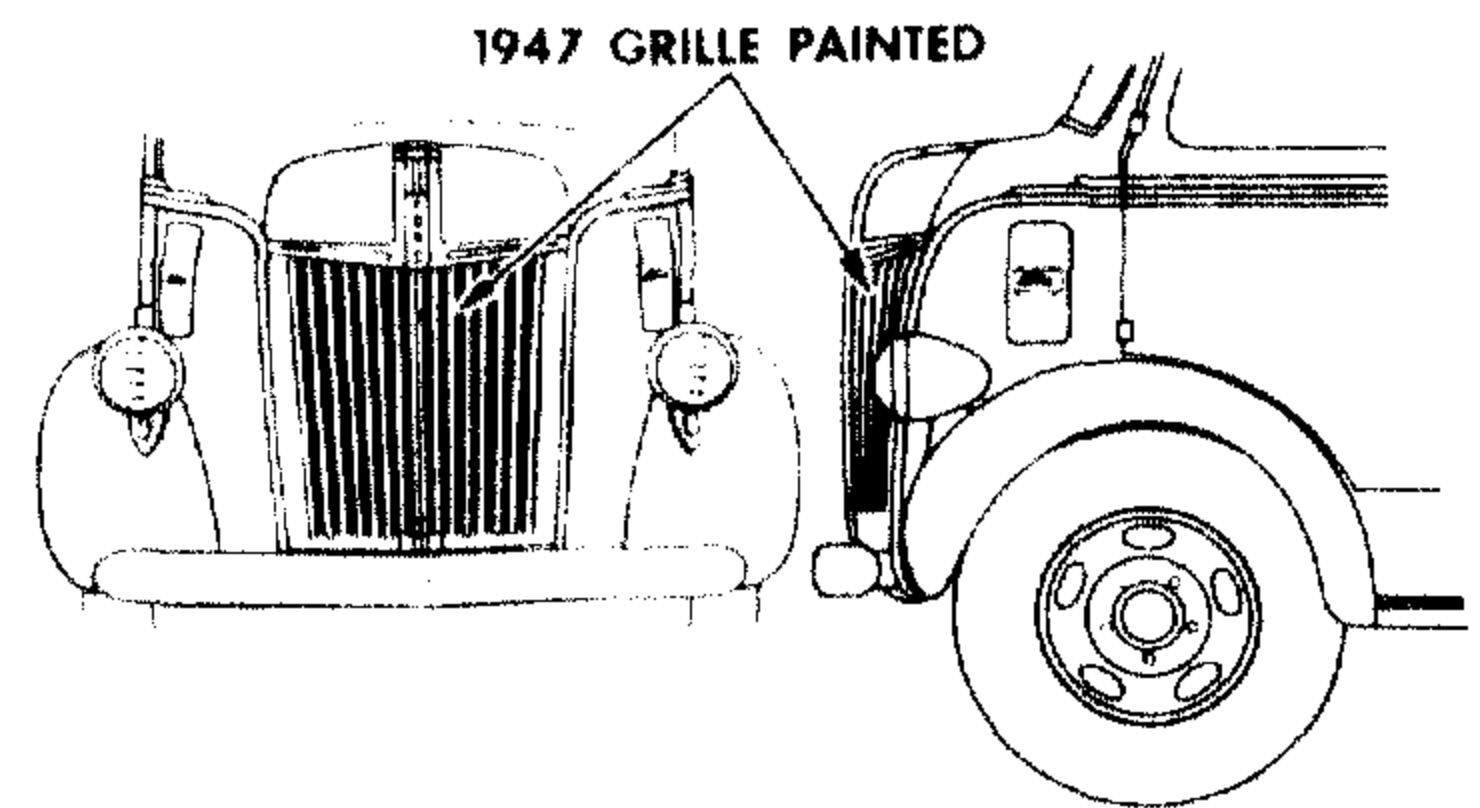
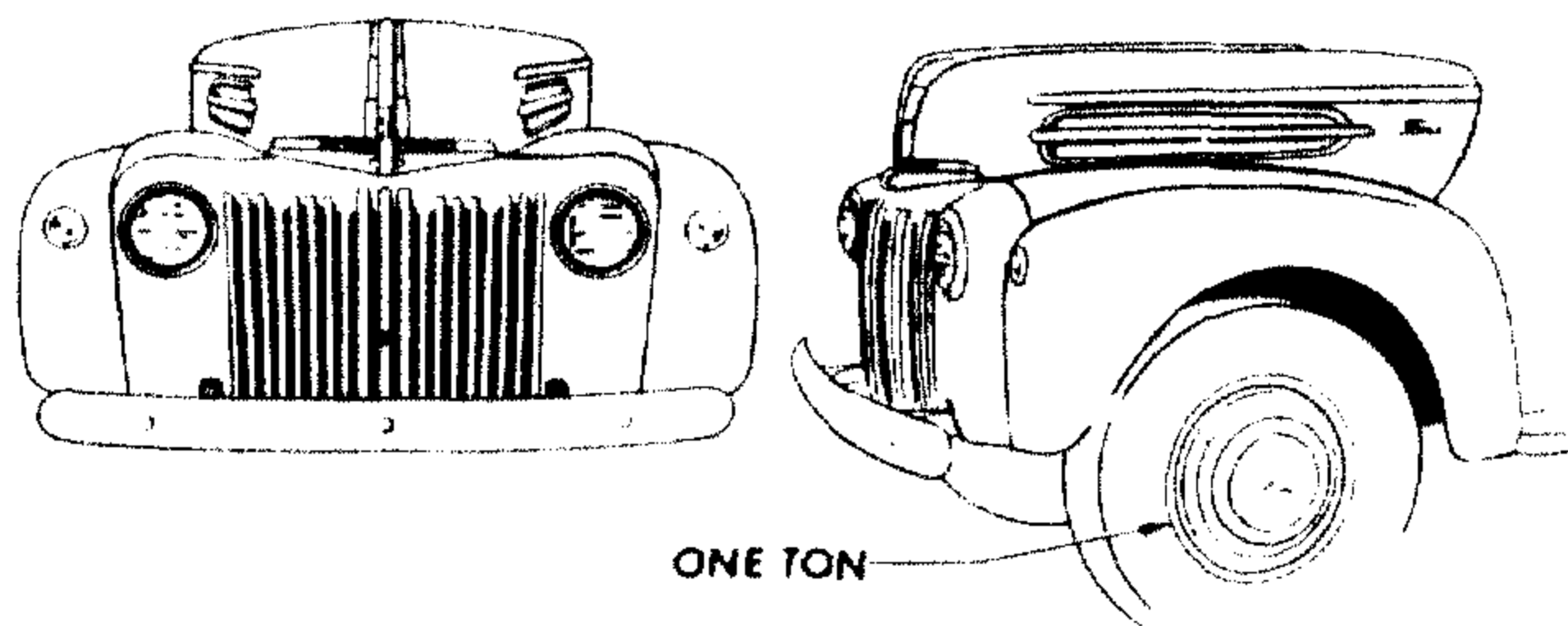

FORD 1 TON TRUCK

MODEL	ENGINE	HP.
79Y	8 cylinder.....	100
7GY	6 cylinder.....	90
7HY	6 cylinder.....	95

FORD CAB-OVER-ENGINE

MODEL	ENGINE	HP.	WHEELBASE
791W	8 cylinder	100.....	101"
79W	8 cylinder	100.....	134"
798W	8 cylinder	100.....	158"

BODY TYPE	NAME	BODY TYPE	NAME
80	Platform (114" Wheelbase)	81	Closed Cab (122", 134", 158" Wheelbase)
80	Platform (1 Ton) (122" Wheelbase)	81	Closed Cab (101", 134", 158" Cab-Over-Engine)
80	Platform (134" Regular and 101" Cab-Over-Engine)	82-A	Panel Delivery (114" Wheelbase)
80	Platform (134" Cab-Over-Engine)	82	Panel Delivery (1 Ton) (122" Wheelbase)
80	Platform (158" Wheelbase)	83	Pickup (114" Wheelbase)
81	Closed Cab (114" Wheelbase)	83	Express (1 Ton) (122" Wheelbase)

1948

FORD PASSENGER CAR MODELS

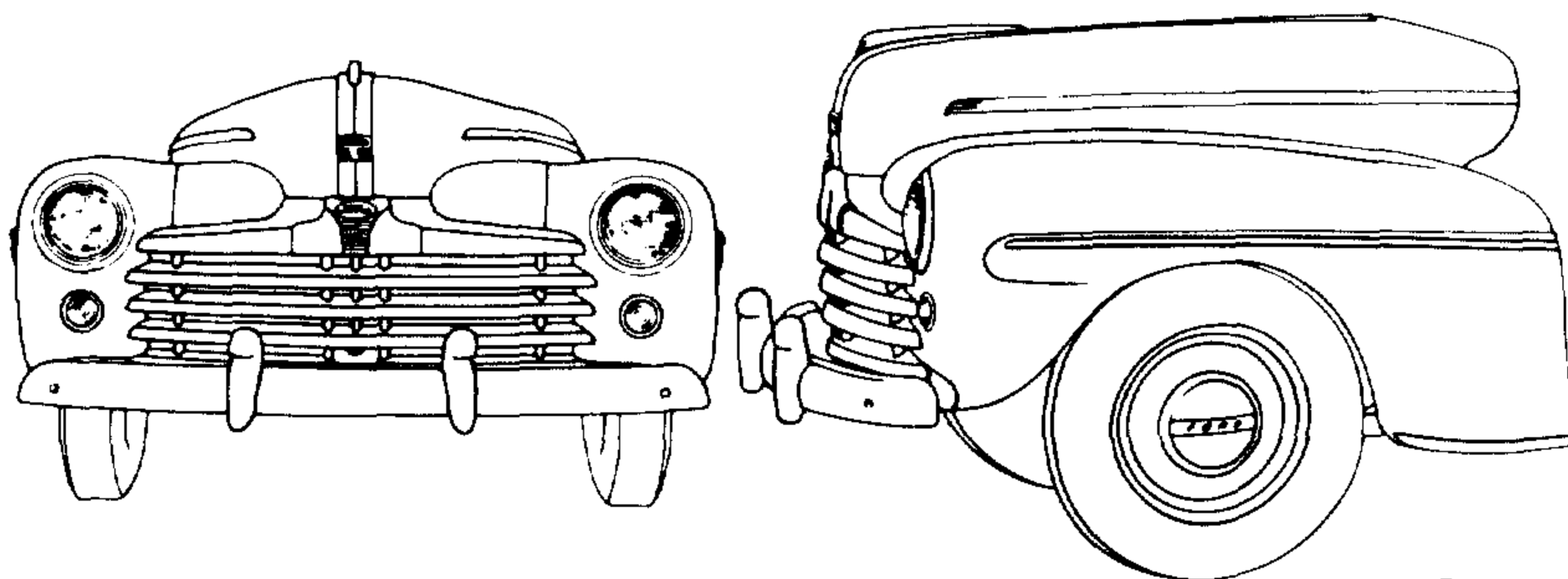

P.926

MODEL 89A FORD DELUXE OR SUPER DELUXE—100 HP. 8-Cylinder Engine

**MODEL 8HA FORD DELUXE OF SUPER DELUXE—95 HP. 6-Cylinder Engine
(114" Wheelbase)**

BODY TYPE	NAME	BODY TYPE	NAME
70-A	De Luxe Tudor Sedan	76	Super De Luxe Convertible Club Coupe
70-B	Super De Luxe Tudor Sedan	77-A	De Luxe (5-Window) Coupe
72-B	Super De Luxe Sedan Coupe	77-B	Super De Luxe (5-Window) Coupe
73-A	De Luxe Fordor Sedan	78	De Luxe Sedan Delivery
73-B	Super De Luxe Fordor Sedan	79-B	Super De Luxe Station Wagon

NOTE: The model prefix has been omitted from the various "Body Types." For the model or type required the model prefix should be added; for example, if a closed cab for a 90 HP. 8 cyl. engine 134" Wheelbase, 1942 truck is required the model number is 21T81. Should a closed cab for a 1942 6 cyl. 134" Wheelbase be required the model number is 2GT81, the 81 indicating any closed cab and 21T or 2GT the model number.